

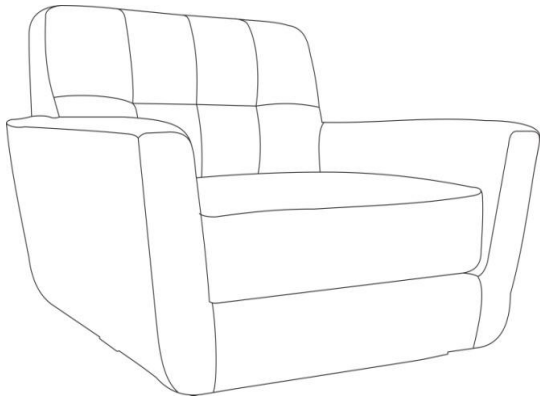





Assembly Instructions

Fabric Armchair

Parts List

picture	Description	QTY
	Chair Body	1
	Leg	2

Hardware List

picture	Description	QTY
	Allen Bolt	4
	Flat Washer	4
	Spring Washer	4
	Allen Key	1

Assembly Steps

Step 1

Place the chair body out of the box and remove dust cover. Place upside down on a soft, secure surface. The legs are on the seat. Remove and open legs and accessories. Position the 2 legs on the chair body, and tighten with allen wrench. Each leg requires 2 Bolts, 1 Bolt will penetrate 1 Flat Washer and 1 Spring Washer.

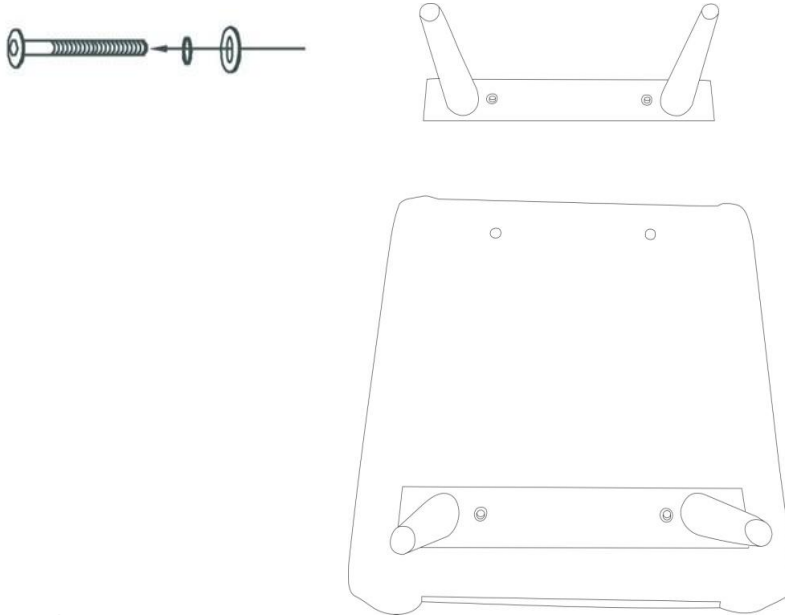

Step 2

Check that all legs are secure. Recommended that bolts are re-tightened after one month of use and when needed, thereafter. Assembly Complete, set upright!

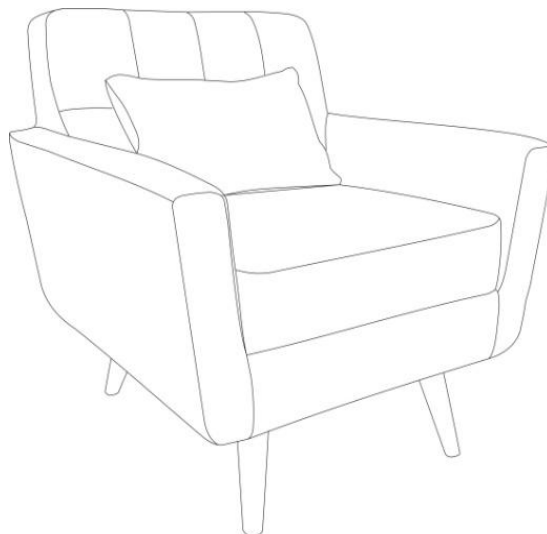

**Dust and pick-up spills using a clean, non-colored, lint-free cloth.
Avoid using abrasive cleaners.**