













ASSEMBLY INSTRUCTION

Headboard

PARTS #		PARTS NAME	DRAWING	QTY
P1		Headboard		1
P2		Left Support Leg with 3 Mounting Brackets (With the sticker "Left" on the bottom)		1
P3		Right Support Leg with 3 Mounting Brackets (With the sticker "Right" on the bottom)		1
Pack A (Used to assemble the headboard)	H1	Bolt M8X25mm		4
	H2	Spring Washer		4
	H3	Flat Washer		4
	H4	Allen Key		1
Pack B (assemble the headboard to the bed frame)	H5	Bolt M8X25mm		5
	H6	Spring Washer		5
	H7	Flat Washer		5
	H8	Nut Cap		5
	H9	Solid Wrench		1

Step 1 . Take out Legs and hardware under the headboard

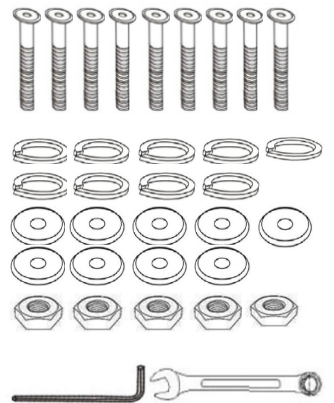
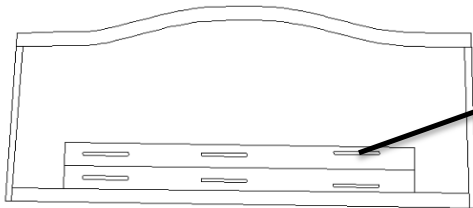

Step 2

Step 2

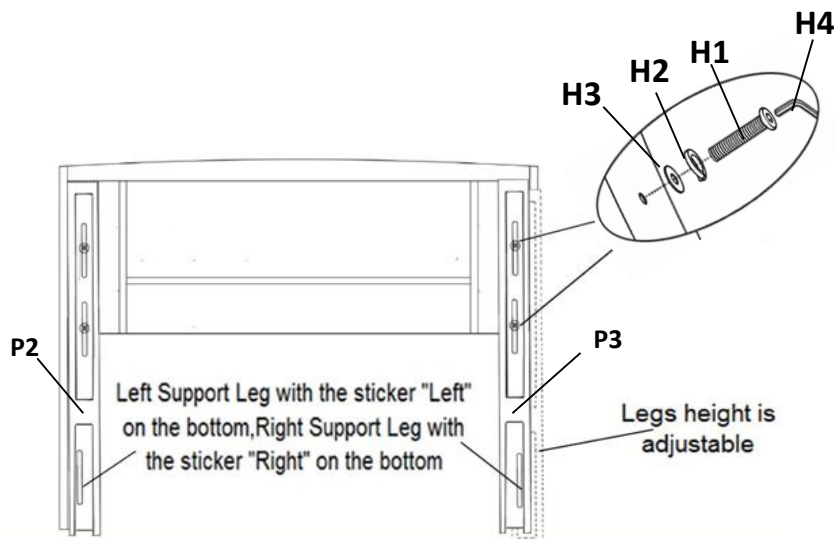

Put the Headboard onto a flat surface.

Align the mounting position on Headboard to the mounting position on Left Support Leg(P2).

Then, lock the top and the middle mounting positions by Flat washer (H3), Spring washer(H2), bolt(H1), Then tighten the bolts with allen wrench (H4) .

Repeat the same steps to install the Right Support Leg(P3).

At this point of assembly, DO NOT overfasten the connections. The final height of the Headboard may be adjusted to your own need.

Step 3 . Headboard is ready to be assembled to bed frame using Pack B Parts.

