



PRODUCT SHEET

TR Collection
by Tim Rundle

Black powder coated steel or brushed brass pendant with textile cord.

PRODUCT OPTIONS



Black, Matte Opal Bulb
1493639

Black, Shiny Opal Bulb
1493629



Brushed Brass, Matte Opal Bulb
1493939

Brushed Brass, Shiny Opal Bulb
1493929

TECHNICAL SPECIFICATIONS

PRODUCT TYPE
Pendant

COLLI
1

ENVIRONMENT
Indoor

DIMENSIONS
H: 30 cm / 11,8"
Ø: 20 cm / 7,9"

COLOURS
Black (RAL 9005)
Brushed brass

PRODUCTION PROCESS
The globe shade is made from mouth-blown opal glass and the core is designed with aluminium to draw heat away from the LED light source, allowing the bulb to run at the optimum temperature. Accessory fittings are made of brushed brass or painted steel.

MATERIALS
Powder coated steel or brushed brass with lacquer, opal glass (matte or shiny), LED COB.

WEIGHT
1,1 kg / 2,4 lb

VOLTAGE
CE: 220-230 V
US: 110-130 V

LIGHT SOURCE & ENERGY EFFICIENCY CLASS
CE: Standard: E27, 6,5 Watt, A+
US: Standard: E26, 6 Watt, A+
Bulbs are dimmable (trailing edge)

LIGHT SPECIFICATIONS

TR Bulb (CE)
Standard
Watt: 6,5 W
Lumen output: 70 lm / W
Colour temperature: 2700 K
CRI: > 80

TR Bulb (US)
Standard
Watt: 6 W
Lumen output: 70 lm / W
Colour temperature: 2700 K
CRI: > 80

DIMMER
No. The lamp can be connected to a dimmer system.

CANOPY
Yes, ABS, black
Ø: 11,5 cm / 4,5"
H: 3,8 cm / 1,5"

CORD MATERIAL AND COLOUR
Textile, black.

CORD LENGTH
300 cm / 118,1"

CLASSIFICATION
IP20

CERTIFICATIONS
CE and ETL certified, tests can be obtained upon request.

PACKAGING TYPE
Gift box

PACKAGING MEASUREMENTS (H x W x D)
26 cm x 36 cm x 25,5 cm / 10,2" x 14,2" x 10"

MATERIALS & MAINTENANCE
Please see page 940 for materials, care and maintenance instructions.

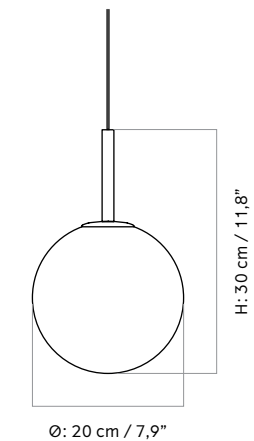

TR Bulb Suspension Frame

BY TIM RUNDLE

Suspension lamp in black powder coated steel or brushed brass. Opal glass bulb with a shiny or matte finish.

PRODUCT OPTIONS

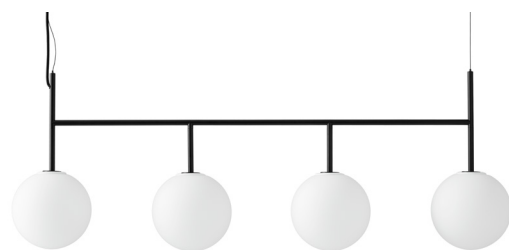

Black, Matte Opal Bulb
1495639

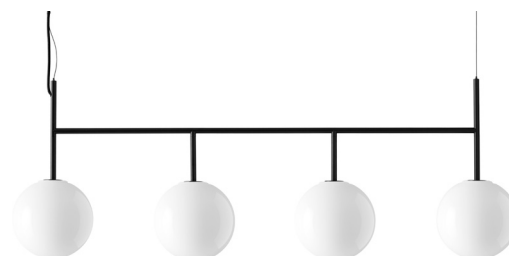

Black, Shiny Opal Bulb
1495629

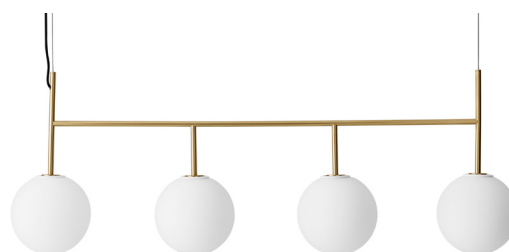

Brushed Brass, Matte Opal Bulb
1465639



Brushed Brass, Shiny Opal Bulb
1465629

TR Bulb Suspension Frame

BY TIM RUNDLE

TECHNICAL SPECIFICATIONS

PRODUCT TYPE
Suspension frame

COLLI
1

ENVIRONMENT
Indoor

DIMENSIONS
H: 45 cm / 17,7"
Æ: 20 cm / 7,9"
W: 125 cm / 49,2"

COLOURS
Black (RAL 9005)
Brushed brass

PRODUCTION PROCESS
The globe shade is made from mouth-blown opal glass and the core is designed with aluminium to draw heat away from the LED light source, allowing the bulb to run at the optimum temperature. Accessory fittings are made of brushed brass or painted steel.

MATERIALS
Powder coated steel or brushed brass with lacquer, opal glass (matte or shiny), LED COB.

WEIGHT
4,4 kg / 9,7 lb

VOLTAGE
CE: 220-230 V
US: 110-130 V

LIGHT SOURCE & ENERGY EFFICIENCY CLASS
CE: Standard: E27, 6,5 Watt, A+
US: Standard: E26, 6 Watt, A+
Bulbs are dimmable (trailing edge)

LIGHT SPECIFICATIONS

TR Bulb (CE)
Standard
Watt: 6,5 W
Lumen output: 70 lm / W
Colour temperature: 2700 K
CRI: > 80

TR Bulb (US)
Standard
Watt: 6 W
Lumen output: 70 lm / W
Colour temperature: 2700 K
CRI: > 80

DIMMER
No. The lamp can be connected to a dimmer system.

CANOPY
Yes, ABS, black
Ø: 11,5 cm / 4,5"
H: 3,8 cm / 1,5"

CORD MATERIAL AND COLOUR
Textile, black

CORD LENGTH
300 cm / 118,1"

CLASSIFICATION
IP20

CERTIFICATIONS
CE and ETL certified, tests can be obtained upon request.

PACKAGING TYPE
Gift box

PACKAGING MEASUREMENTS (H x W x D)
26,5 cm x 136,5 cm x 43,8 cm / 10,4" x 53,7" x 17,2"

MATERIALS & MAINTENANCE
Please see page 940 for materials, care and maintenance instructions.

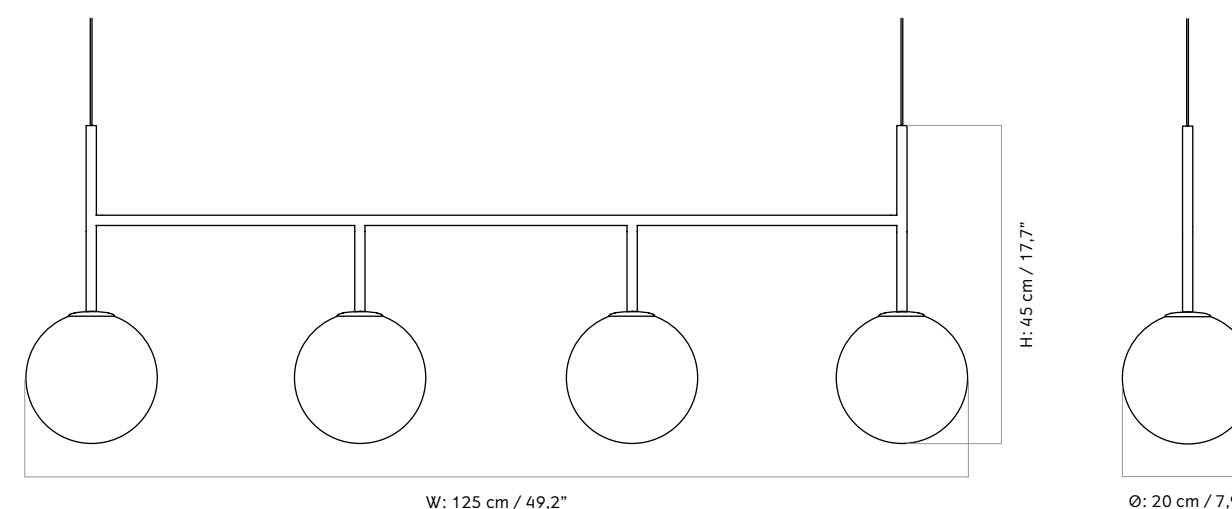



TR Bulb Table Lamp

BY TIM RUNDLE

Black powder coated steel lamp with circular Ocean Grey Marble base or brushed brass. Opal glass bulb with a shiny or matte finish. Textile cord with dimmer switch.

PRODUCT OPTIONS



Ocean Grey Marble, Matte Opal Bulb
1491639



Ocean Grey Marble, Shiny Opal Bulb
1491629



Brushed Brass, Matte Opal Bulb
1461639



Brushed Brass, Shiny Opal Bulb
1461629



TR Bulb Table Lamp

BY TIM RUNDLE

TECHNICAL SPECIFICATIONS

PRODUCT TYPE
Table lamp

COLLI
1

ENVIRONMENT
Indoor

DIMENSIONS
H: 41 cm / 16,1"
Ø: 18 or 20 cm / 7,1" or 7,9"

COLOURS
Ocean Grey Marble
Brushed brass

PRODUCTION PROCESS
The globe shade is made from mouth-blown opal glass and the core is designed with aluminium to draw heat away from the LED light source, allowing the bulb to run at the optimum temperature. Accessory fittings are made from cut and polished marble, brushed brass or painted steel.

MATERIALS
Powder coated steel or brushed brass with lacquer, opal glass (matte or shiny), LED COB.

WEIGHT
1,7 kg / 3,7 lb

VOLTAGE
CE: 220-230 V
US: 110-130 V

LIGHT SOURCE & ENERGY EFFICIENCY CLASS
CE: Standard: E27, 6,5 Watt, A+
US: Standard: E26, 6 Watt, A+
Bulbs are dimmable (trailing edge)

LIGHT SPECIFICATION

TR Bulb (CE)
Standard
Watt: 6,5 W
Lumen output: 70 lm / W
Colour temperature: 2700 K
CRI: > 80

TR Bulb (US)
Standard
Watt: 6 W
Lumen output: 70 lm / W
Colour temperature: 2700 K
CRI: > 80

DIMMER
Yes, on cord

CANOPY
No

CORD MATERIAL AND COLOUR
Black textile and black plug.

CORD LENGTH
200 cm / 78,7"

CLASSIFICATION
IP20

CERTIFICATIONS
CE and ETL certified, tests can be obtained upon request.

PACKAGING TYPE
Gift box

PACKAGING MEASUREMENTS (H x W x D)
26,5 cm x 36 cm x 32,5 cm / 10,4" x 14,2" x 12,8"

MATERIALS & MAINTENANCE
Please see page 940 for materials, care and maintenance instructions.

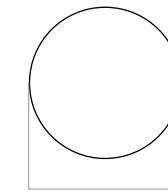

Ø: 20 cm / 7,9"

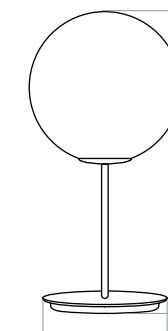

Ø: 18 cm / 7,1"

H: 41 cm / 16,1"

TR Bulb Table/Wall Lamp

BY TIM RUNDLE

Black powder coated steel lamp with circular Ocean Grey Marble base or brushed brass. Opal glass bulb with a shiny or matte finish. Textile cord with dimmer switch.

PRODUCT OPTIONS



Ocean Grey Marble, Matte Opal Bulb
1492639



Ocean Grey Marble, Shiny Opal Bulb
1492629



Brushed Brass, Matte Opal Bulb
1462639



Brushed Brass, Shiny Opal Bulb
1462629

TR Bulb Table/Wall Lamp

BY TIM RUNDLE

TECHNICAL SPECIFICATIONS

PRODUCT TYPE
Table / Wall lamp

COLLI
1

ENVIRONMENT
Indoor

DIMENSIONS
H: 22 cm / 8,7"
Ø: 16 or 20 cm / 6,2" or 7,9"

COLOURS
Ocean Grey Marble
Brushed brass

PRODUCTION PROCESS
The globe shade is made from mouth-blown opal glass and the core is designed with aluminium to draw heat away from the LED light source, allowing the bulb to run at the optimum temperature. Accessory fittings are made from cut and polished marble, brushed brass or painted steel.

MATERIALS
Powder coated steel or brushed brass with lacquer, opal glass (matte or shiny), LED COB.

WEIGHT
1,6 kg / 3,5 lb

VOLTAGE
CE: 220-230 V
US: 110-130 V

LIGHT SOURCE & ENERGY EFFICIENCY CLASS
CE: Standard: E27, 6,5 Watt, A+
US: Standard: E26, 6 Watt, A+
Bulbs are dimmable (trailing edge)

LIGHT SPECIFICATION

TR Bulb (CE)
Standard
Watt: 6,5 W
Lumen output: 70 lm / W
Colour temperature: 2700 K
CRI: > 80

TR Bulb (US)
Standard
Watt: 6 W
Lumen output: 70 lm / W
Colour temperature: 2700 K
CRI: > 80

DIMMER
Yes, on cord

CANOPY
No

CORD MATERIAL AND COLOUR
Black textile and black plug.

CORD LENGTH
200 cm / 78,7"

CLASSIFICATION
IP20

CERTIFICATIONS
CE and ETL certified, tests can be obtained upon request.

PACKAGING TYPE
Gift box

PACKAGING MEASUREMENTS (H x W x D)
26 cm x 50 cm x 25,6 cm / 10" x 19,7" x 10"

MATERIALS & MAINTENANCE
Please see page 940 for materials, care and maintenance instructions.

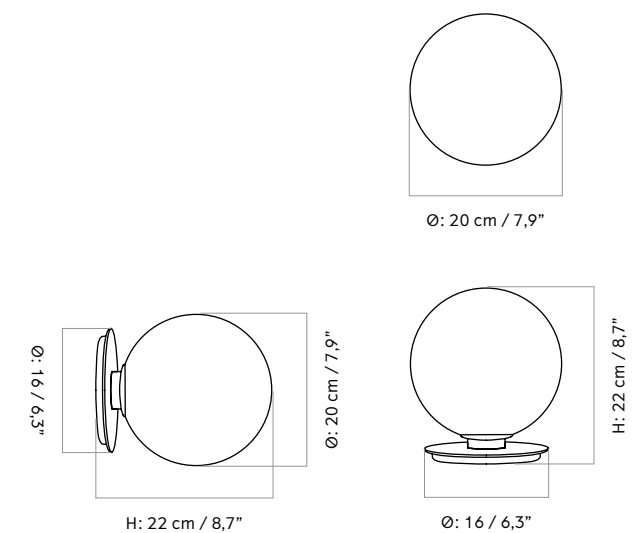

TR Bulb Ceiling/Wall Lamp

BY TIM RUNDLE

Black powder coated steel or brushed brass ceiling / wall lamp with PVC cord. Opal glass bulb with a shiny or matte finish.

PRODUCT OPTIONS



Black, Matte Opal Bulb
1494639



Black, Shiny Opal Bulb
1494629



Brushed Brass, Matte Opal Bulb
1464639



Brushed Brass, Shiny Opal Bulb
1464629

TR Bulb Ceiling/Wall Lamp

BY TIM RUNDLE

TECHNICAL SPECIFICATIONS

PRODUCT TYPE
Ceiling / Wall lamp

COLLI
1

ENVIRONMENT
Indoor

DIMENSIONS
H: 22 cm / 8,7"
Ø: 16 or 20 cm / 6,2" or 7,9"

COLOURS
Black (RAL 9005)
Brushed brass

PRODUCTION PROCESS
The globe shade is made from mouth-blown opal glass and the core is designed with aluminium to draw heat away from the LED light source, allowing the bulb to run at the optimum temperature. Accessory fittings are made of brushed brass or painted steel.

MATERIALS
Powder coated steel or brushed brass with lacquer, opal glass (matte or shiny), LED COB

WEIGHT
1,6 kg / 3,5 lb

VOLTAGE
CE: 220-230 V
US: 110-130 V

LIGHT SOURCE & ENERGY EFFICIENCY CLASS
CE: Standard: E27, 6,5 Watt, A+
US: Standard: E26, 6 Watt, A+
Bulbs are dimmable (trailing edge)

LIGHT SPECIFICATION

TR Bulb (CE)
Standard
Watt: 6,5 W
Lumen output: 70 lm / W
Colour temperature: 2700 K
CRI: > 80

TR Bulb (US)
Standard
Watt: 6 W
Lumen output: 70 lm / W
Colour temperature: 2700 K
CRI: > 80

DIMMER
No. The lamp can be connected to a dimmer system.

CANOPY
No

CORD MATERIAL AND COLOUR
PVC, black

CORD LENGTH
10 cm / 3,9"

CLASSIFICATION
IP20

CERTIFICATIONS
CE and ETL certified, tests can be obtained upon request.

PACKAGING TYPE
Gift box

PACKAGING MEASUREMENTS (H x W x D)
43 cm x 48,5 cm x 48,5 cm / 17" x 19" x 19"

MATERIALS & MAINTENANCE
Please see page 940 for materials, care and maintenance instructions.

