





Thank you for purchasing this quality product. Be sure to unpack carefully looking for small parts which may have come loose during shipment. Read all instruction and study the drawing carefully before starting the assembly process.

HARDWARE LIST

NO.	DRAWING	DESCRIPTION	SIZE	Q'TY
A		Threaded Bolts	Ø5/16"*4"	8 PCS
B		Curved Washers	Ø5/16"	8 PCS
C		Nut	Ø5/16"	8 PCS
D		Open Wrench	13mm	1 PCS
E		Screw	Ø8*1-1/4"	8 PCS

- STEP 1. Attach the threaded bolts (A) into the two threaded holes that are at the bottom of the posts of Bolt the Headboard and the Footboard. Slide the Bed Rail onto the two Bolts (A) on one of the bed posts until the Bolts (A) are visible through the holes on the inside of the Bed Rail.
- STEP 2. Slide a Curved Washer (B) and a Nut (C) onto the Bolts (A) through the holes in the bed rail. Tighten all the Nuts (C), using the Open Wrench (D).
- STEP 3. Assemble the leg supports to the bed slats.
- STEP 4. Mount the assembled support slats onto the side rail with screws (E), use a Phillips head screwdriver to tighten screws

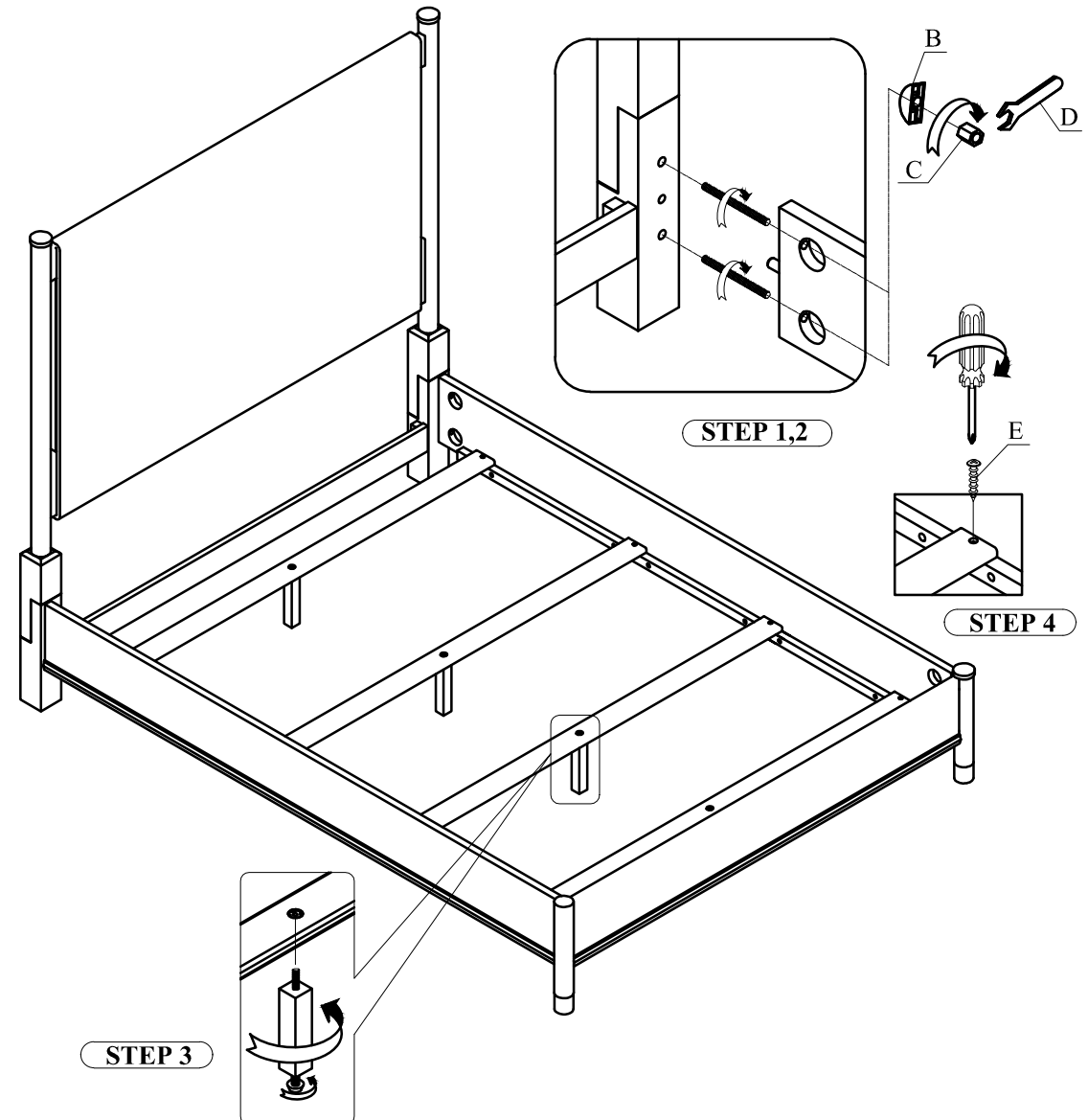





ASSEMBLY INSTRUCTION

Item: 6050-90967/90868/90863 6-0 Upholstered Bed
6050-90967/90868/90853 6-6 Upholstered Bed

Thank you for purchasing this quality product. Be sure to unpack carefully looking for small parts which may have come loose during shipment. Read all instruction and study the drawing carefully before starting the assembly process.

HARDWARE LIST

N0.	DRAWING	DESCRIPTION	SIZE	Q'TY
A		Threaded Bolts	Ø5/16"*4"	8 PCS
B		Curved Washers	Ø5/16"	8 PCS
C		Nut	Ø5/16"	8 PCS
D		Open Wrench	13mm	1 PCS
E		Screw	Ø8*1-1/4"	10 PCS

- STEP 1. Attach the threaded bolts (A) into the two threaded holes that are at the bottom of the posts of Bolt the Headboard and the Footboard. Slide the Bed Rail onto the two Bolts (A) on one of the bed posts until the Bolts (A) are visible through the holes on the inside of the Bed Rail.
- STEP 2. Slide a Curved Washer (B) and a Nut (C) onto the Bolts (A) through the holes in the Bed rail. Tighten all the Nuts (C), using the Open Wrench (D).
- STEP 3. Assemble the leg supports to the bed slats.
- STEP 4. Mount the assembled support slats onto the side rail with screws (E), use a Phillips head screwdriver to tighten screws

