



# ZIPPITY

*Easy Does It!*

**HAMPTON**  
OUTDOOR VINYL  
SHOWER KIT  
(62"W X 47"L X 89"H)

**ASSEMBLY**  
INSTRUCTIONS  
ZP19009

**6 HOURS**

*Approximate assembly and installation time*

Want to see a video on how to  
assemble this product?  
Scan the QR code

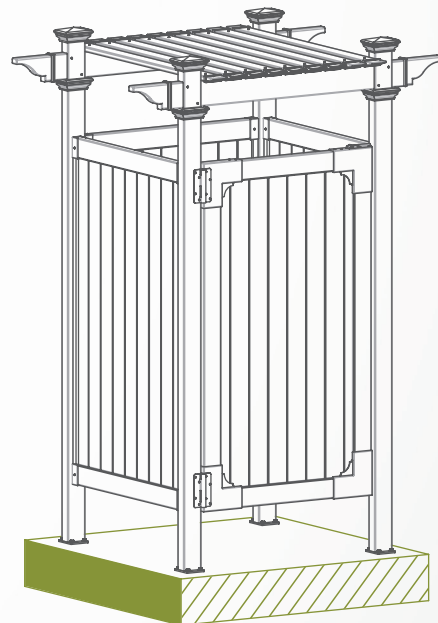
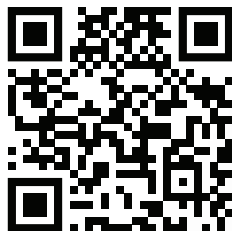

## GENERAL INFORMATION



### IMPORTANT

- + Check the inside of the larger pieces in your box for other materials packed inside.
- + When assembling components, place on a non-abrasive surface (i.e. shipping box) to avoid scratching.
- + We recommend an area approximately 5'x 8' for unobstructed assembling.
- + You should not need to use excessive force when assembling components.

## MISSING OR DAMAGED PARTS?

### VISIT OUR WEBSITE FIRST, SO WE CAN HELP YOU RIGHT AWAY!

Although great care has been taken to ensure proper packaging and handling of this product, occasionally problems occur. If you discover any missing, damaged, or defective parts, please visit our website to order replacement parts. If you experience any further trouble with your product, please contact our customer service department.

 [parts.nychbrands.com](http://parts.nychbrands.com)

 [support@zippity-outdoor.com](mailto:support@zippity-outdoor.com)

 **704-892-5222 / 877-234-6196**

*Customer service agents are available to take calls weekdays from 9am-5pm EST. If you call outside of business hours, please leave a voicemail.*

To help you quickly and accurately, please have reference item number **ZP19009** and the specific part name which can be found on page 4 and 5. It is helpful if you can provide the batch lot which is a stamped number on the inside of the box.

## NEED ASSEMBLY HELP?

If you are having problems with the assembly or installation of this product, we are happy to assist you with the process, **so please give us a call at 704-892-5222 / 877-234-6196.**







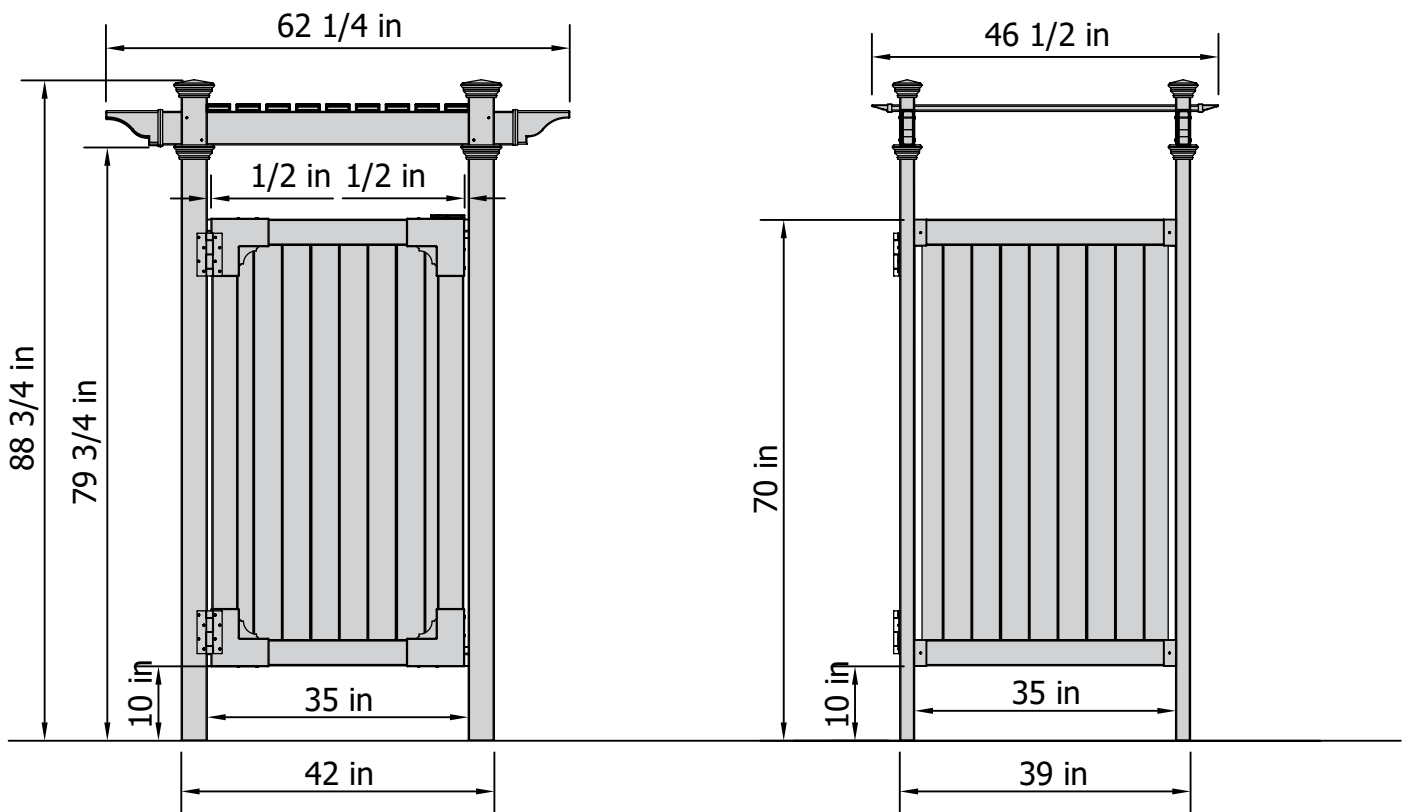
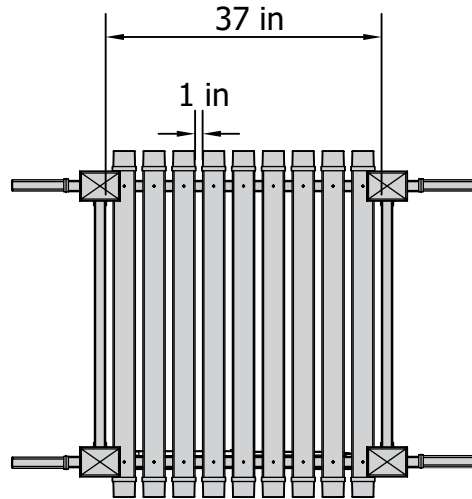

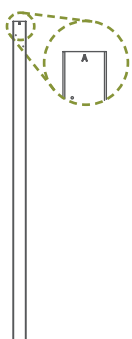
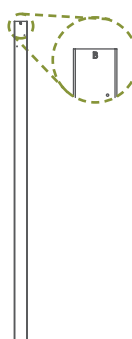

## NEED TO RETURN?

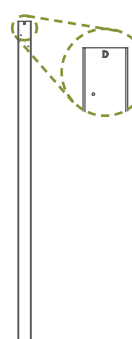
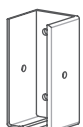

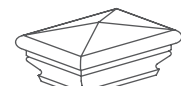
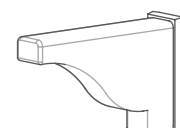
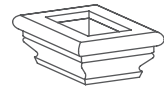

If for some reason you need to return this product, please allow us to help resolve your issues first. If you still decide to return the product, **you will need to initiate the return from the company you originally purchased from.**

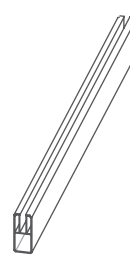
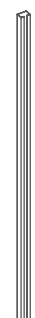
## Detailed Product Dimensions & Specifications



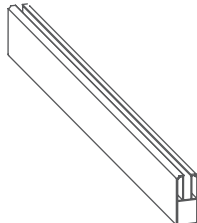
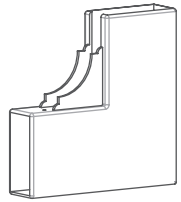

# STEP 1: LAY OUT MATERIALS

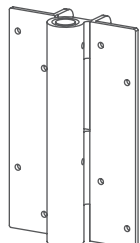
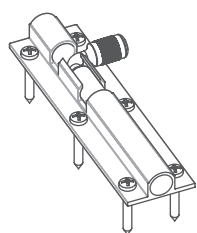
<p><b>A</b></p>  <p><b>Post A (1)</b> 2" x 3½" x 87⅞"</p>	<p><b>B</b></p>  <p><b>Post B (1)</b> 2" x 3½" x 87⅞"</p>	<p><b>C</b></p>  <p><b>Post C (1)</b> 2" x 3½" x 87⅞"</p>	<p><b>D</b></p>  <p><b>Post D (1)</b> 2" x 3½" x 87⅞"</p>	<p><b>M</b></p>  <p><b>Rail Bracket (12)</b></p>
				<p><b>N</b></p>  <p><b>1¼" White Self-Drilling Stainless Steel Screw (89)</b></p>
<p><b>E</b></p>  <p><b>Post Cap (4)</b></p>	<p><b>F</b></p>  <p><b>Decorative End Cap (4)</b></p>	<p><b>G</b></p>  <p><b>Post Trim Cap (4)</b></p>	<p><b>H</b></p>  <p><b>Shade Slat (9)</b></p>	<p><b>O</b></p>  <p><b>1¼" Black Self-Drilling Stainless Steel Screw (36)</b></p>
<p><b>I</b></p>  <p><b>Privacy Board (11)</b> ½" x 12" x 56⅜"</p>	<p><b>J</b></p>  <p><b>Beam (2)</b> 1½" x 4½" x 48"</p>	<p><b>K</b></p>  <p><b>Horizontal Rail (6)</b> 1½" x 3½" x 34⅞"</p>	<p><b>L</b></p>  <p><b>U-Channel (6)</b> ⅞" x 1½" x 53"</p>	<p><b>P</b></p>  <p><b>¾" Self-Drilling Stainless Steel Screw (80)</b></p>
				<p><b>Q</b></p>  <p><b>Vinyl Weld Glue</b></p>

<p><b>R</b></p>  <p><b>Privacy Board -Narrow (1)</b> 1/2" x 6 3/4" x 56 3/8"</p>	<p><b>S</b></p>  <p><b>Privacy Strip (2)</b> 7/8" x 3" x 57"</p>	<p><b>T</b></p>  <p><b>Door Horizontal Rail (2)</b> 1 1/2" x 3 1/2" x 33 5/8"</p>	<p><b>U</b></p>  <p><b>Corner Brackets (4)</b></p>
<p><b>V</b></p>  <p><b>Vertical Door Rail (2)</b> 1 1/2" x 3 1/2" x 53"</p>	<p><b>W</b></p>  <p><b>Door Brace (1)</b></p>	<p><b>X</b></p>  <p><b>Hinge (2)</b></p>	<p><b>Y</b></p>  <p><b>Latch Kit w/ 3/4" Steel Screws (1)</b></p>

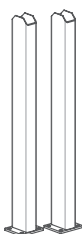
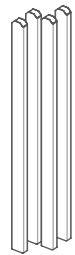
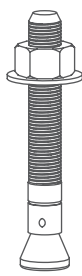
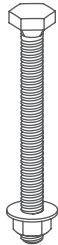
## NOT INCLUDED WITH PURCHASE

<p><i>Sold Separately</i></p>  <p><b>(ZP19011) Zippy Surface Mount 2-Pack (2)</b></p> <p>For wood or concrete surface mounting</p>	<p><i>Sold Separately</i></p>  <p><b>(ZP19012) Zippy Post Extension 4-Pack (1)</b></p> <p>For in-ground installation</p>	 <p><b>1/4" x 3" Concrete Wedge Anchor (16)</b></p> <p>Only needed if installed on concrete</p>	 <p><b>1/4" x 4" Hex Head Bolt w/Nut and Washer (16)</b></p> <p>Only needed if installed on wood</p>	 <p><b>80 lb Concrete Mix (2)</b></p> <p>Only needed if installed in ground</p>
---	---	--	---	--

## STEP 2: INSTALL MOUNTING ACCESSORIES

### STEP 2.1a ▶

#### ▶ Concrete or Wood Surface Mounting:

Insert (4) surface mounts (ZP19011) into the bottom of all 4 posts. The surface mount will be secured in the next step.

*Note: Surface mounts sold separately*

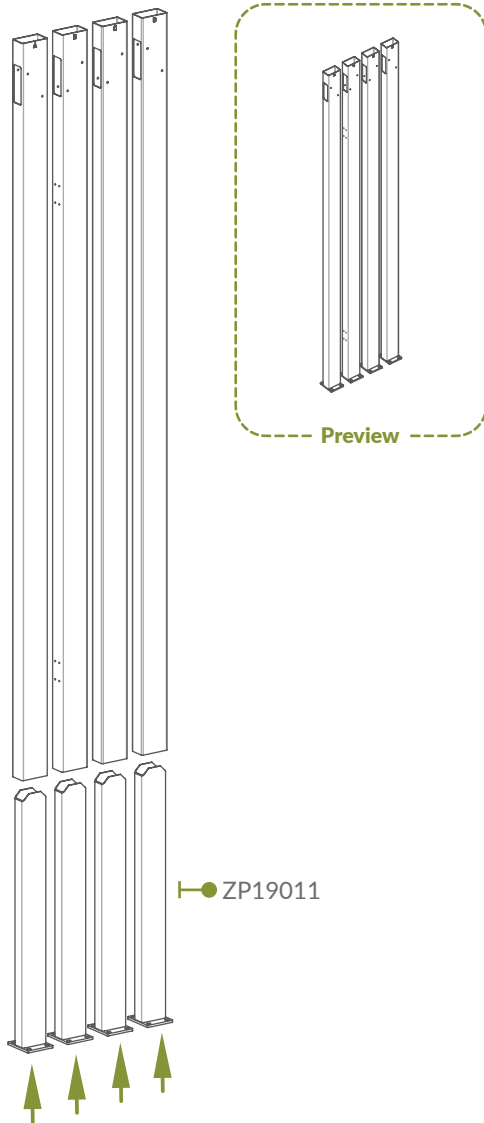

### STEP 2.1b ▶

#### ▶ In-Ground Installation:

Insert (4) post extensions (ZP19012) into the bottom of all 4 posts. The post extensions will be secured in the next step.

*Note: Post extensions sold separately*

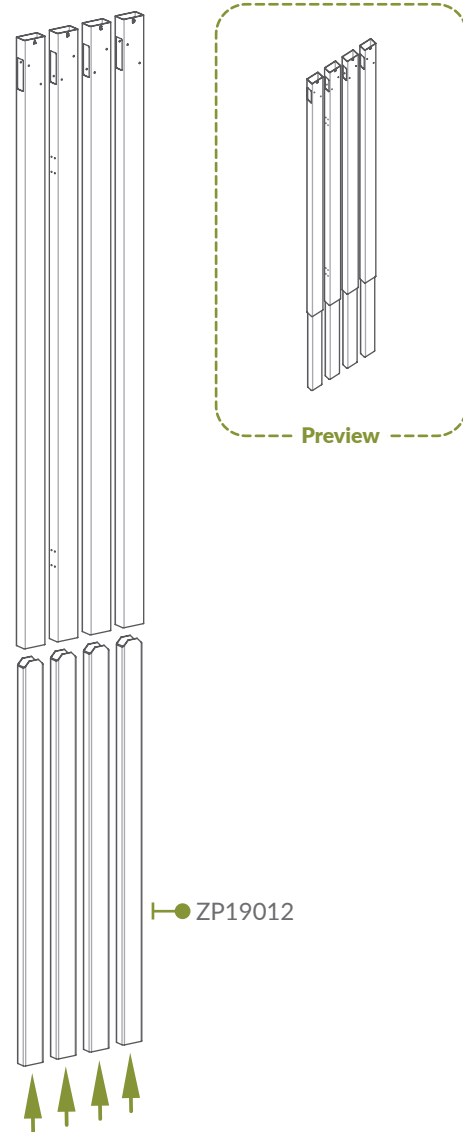

## STEP 3: INSTALL BRACKETS

### STEP 3.1 ▶

1. Place Post A (**A**) on to a flat surface. Orient (2) Rail Brackets (**M**) so that the pre-drilled holes in the bracket align with the pre-drilled holes in the post as shown below.

2. Drive (8)  $\frac{3}{4}$ " Self-Drilling Stainless Steel Screws (**P**) into the aligned holes, securing the brackets to post A.

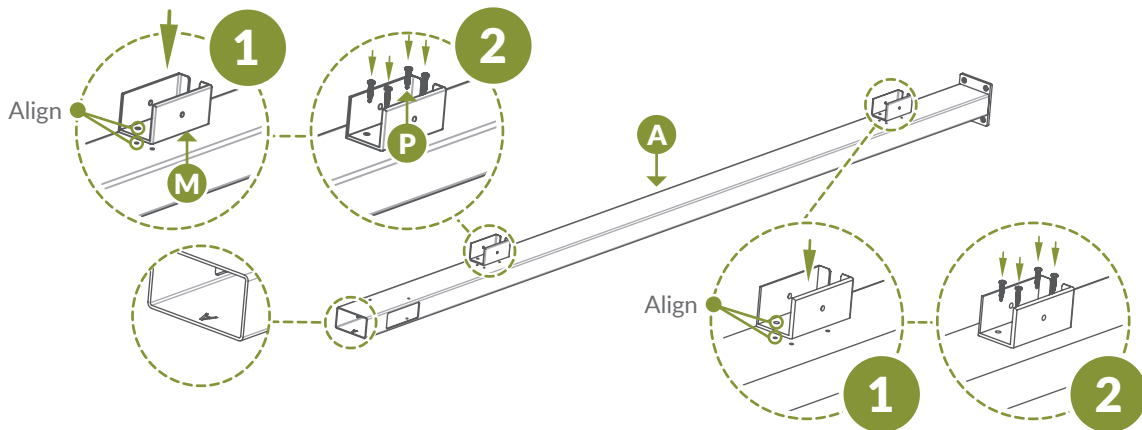

### STEP 3.2 ▶

▶ Repeat step 3.1 for Post B (**B**), Post C (**C**), and Post D (**D**). Two additional brackets will need to be installed on the side face of both post B and post D. Align the brackets with the pre-drilled holes in the sides of these posts and secure the brackets with (16)  $\frac{3}{4}$ " self-drilling stainless steel screws.

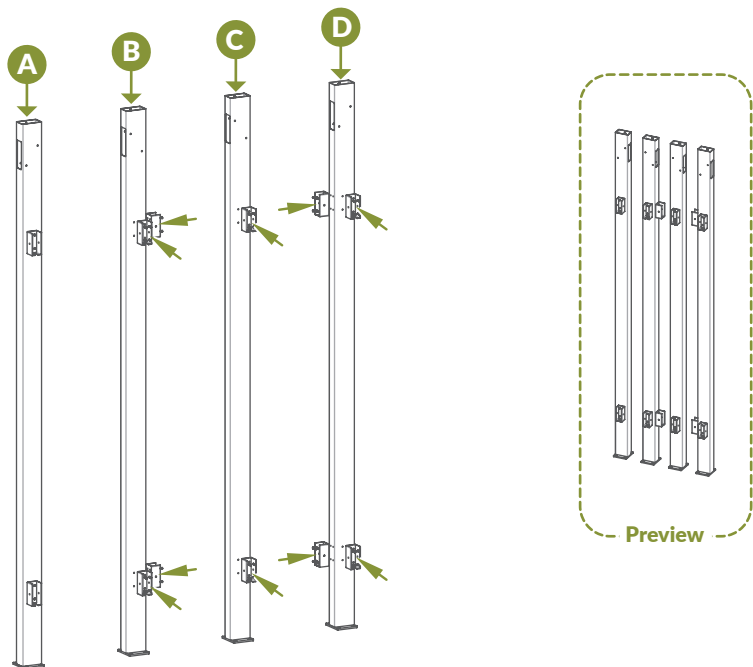

## STEP 4: INSTALL U-CHANNELS

### STEP 4.1 ▶

1. Position (1) U-Channel (L) between the two brackets. Ensure the open groove of the U-channel is centered with the brackets.
2. Drive (3) 1¼" White Self-Drilling Stainless Steel Screws (N) through the pre-drilled holes in the U-channel.

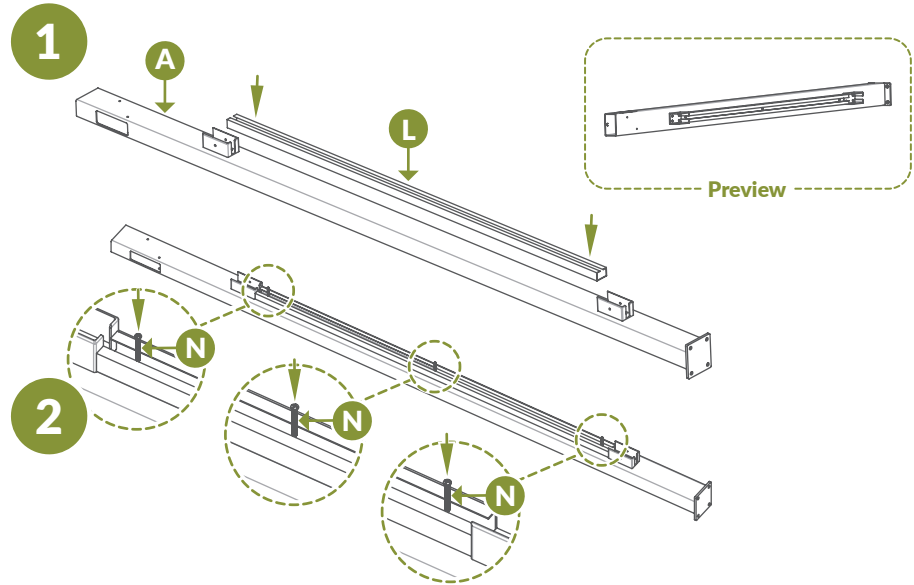

### STEP 4.2 ▶

- ▶ Install the U-channels between the brackets on the remaining 3 posts in the same manner as step 4.1. Post B and post D will each have (2) U-channels on each post.

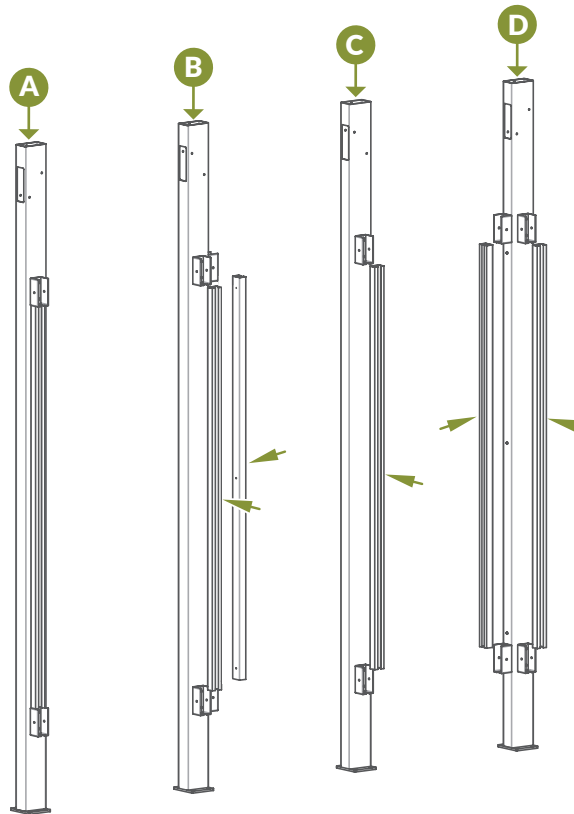



## STEP 5: ASSEMBLE SIDE PANELS

### STEP 5.1

1. Position post A and post B as shown.

2. Slide (1) Horizontal Rail (K) into the rail brackets.

3. Drive (4)  $\frac{3}{4}$ " self-drilling stainless steel screws into the pre-drilled holes in the rail brackets.

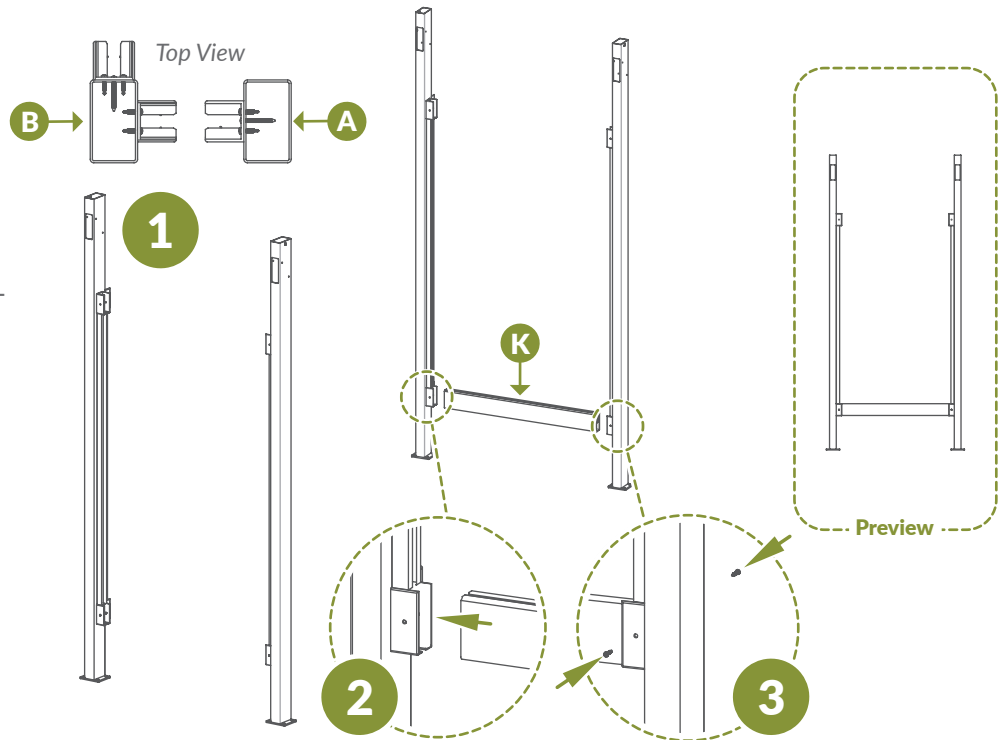

### STEP 5.2

1. Insert (1) Privacy Board (I) into the bottom rail. Angling the board, insert it into the U-channel as shown.

2. Insert (1) privacy board on the other end of the rail as shown.

3. Slide (1) privacy board down the middle of the boards vertically as shown.

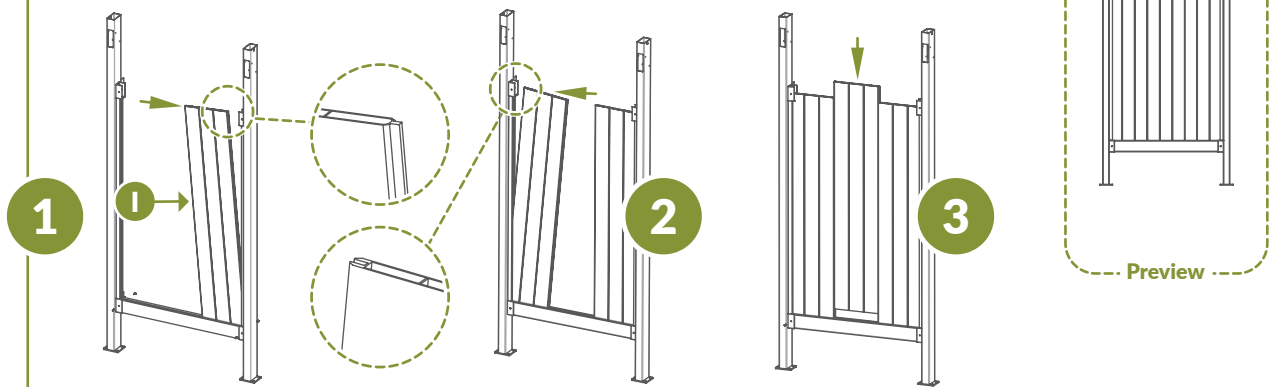

**STEP 5.3**

**1.** Slide (1) horizontal rail down over the privacy boards starting at one end of the boards as shown. Ensure that the rail is inserted fully over the boards and rests inside the rail brackets.

**2.** Drive (4) 3/4" self-drilling stainless steel screws through the pre-drilled holes in the front and back of the rail brackets.

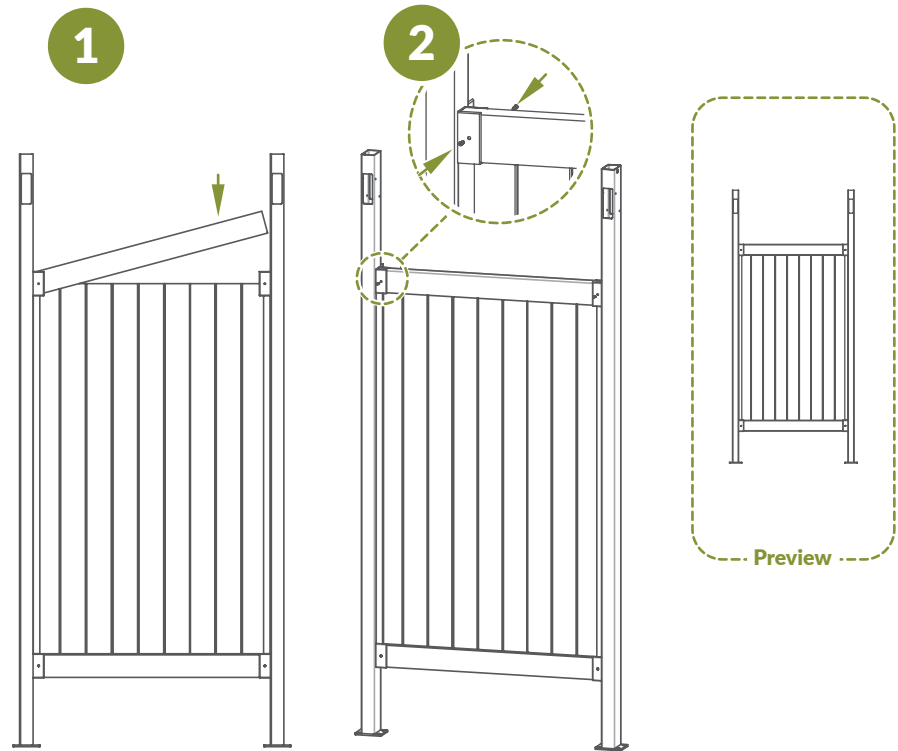

**STEP 5.4**

**1.** Orient post C and post D as shown below.

**2.** Repeat steps 5.1 - 5.3 for these posts to create the second shower wall.

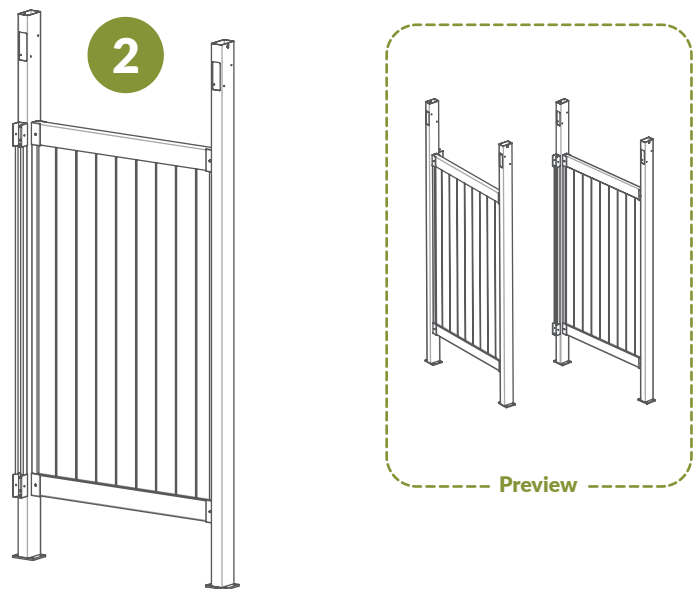
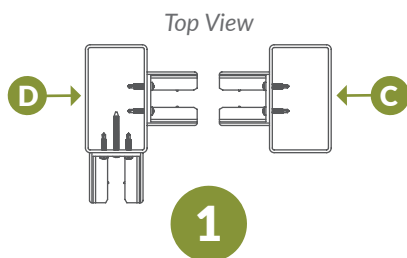

## STEP 6: ASSEMBLE THE BACK PANEL

### STEP 6.1

1. Position the side walls as shown below.
2. Slide (1) horizontal rail into the rail brackets.
3. Drive (4)  $\frac{3}{4}$ " self-drilling stainless steel screws into the rail brackets.

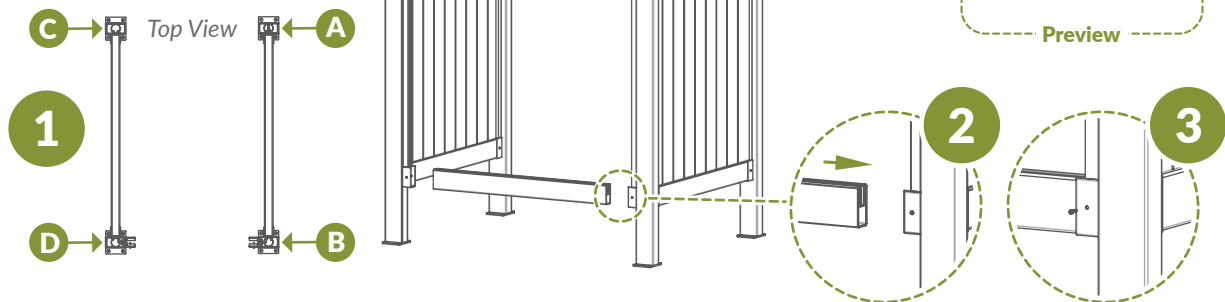

### STEP 6.2

1. Insert (1) privacy board into the bottom rail. Angling the board, insert it into the U-channel as shown.
2. Insert (1) privacy board on the other end of the rail as shown.
3. Slide (1) privacy board down the middle of the boards vertically as shown.

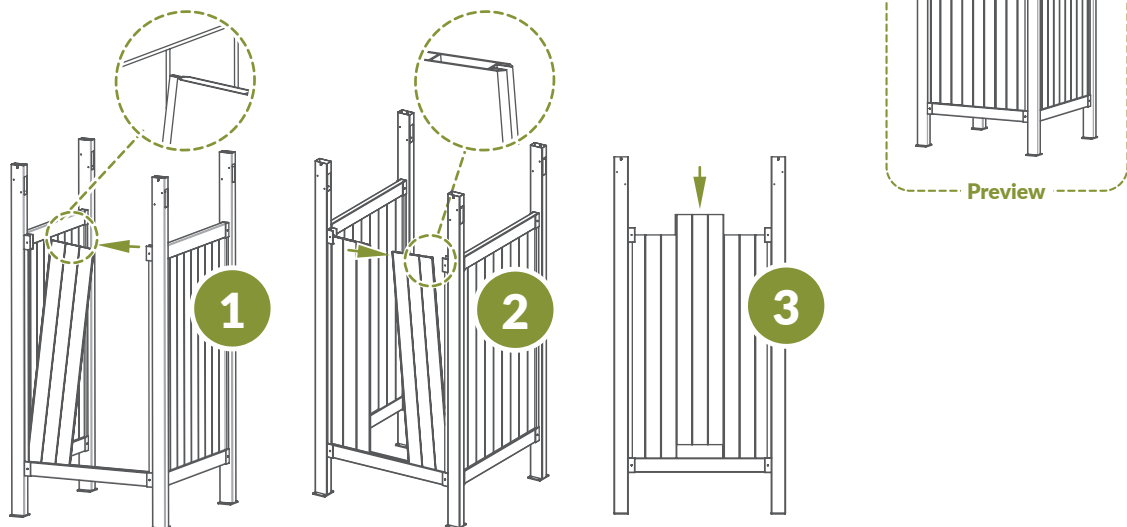

**STEP 6.3** ▶

1. Slide (1) horizontal rail into the upper rail brackets.
2. Drive (4) ¼" self-drilling stainless steel screws into the upper rail brackets.

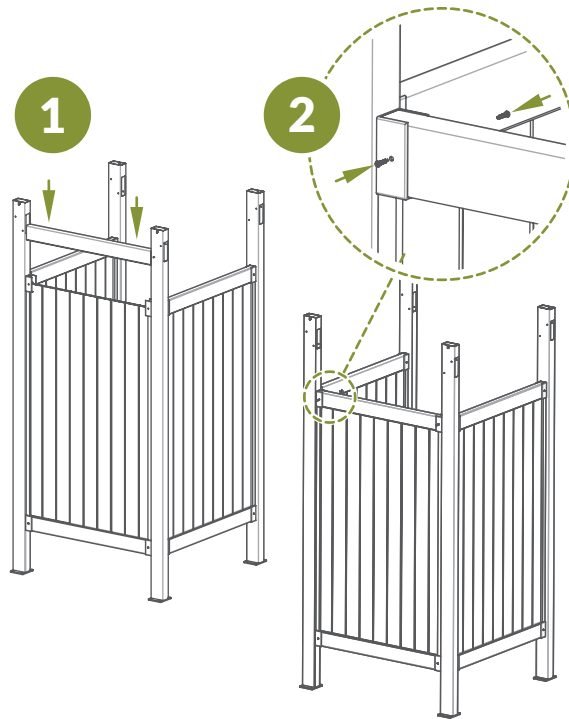
**STEP 7: INSTALL BEAMS AND TRIM PIECES****STEP 7.1** ▶

1. Slide (4) Post Trim Caps (G) over the top of the posts.
2. Slide the trim caps until they are just below the routed holes in the posts as shown.

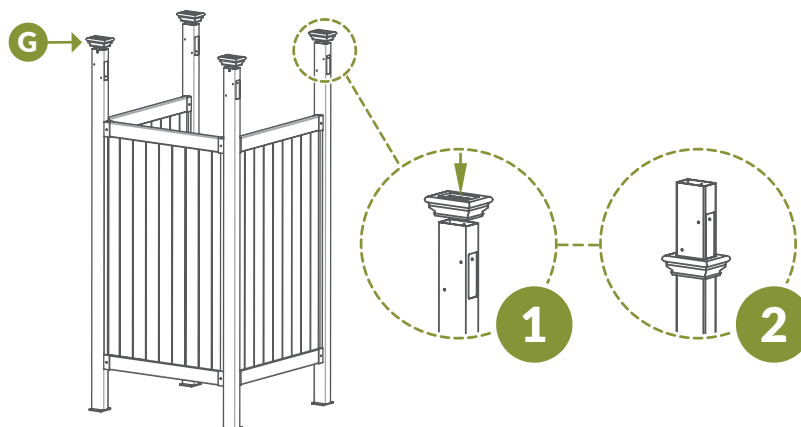

## STEP 7.2 ▶

1. Slide the Beams (J) into the routed holes in the posts.
2. Ensure that there is equal length of beam on each side of the shower.
3. Secure the beams with (16) 1¼" white self-drilling stainless steel screws.

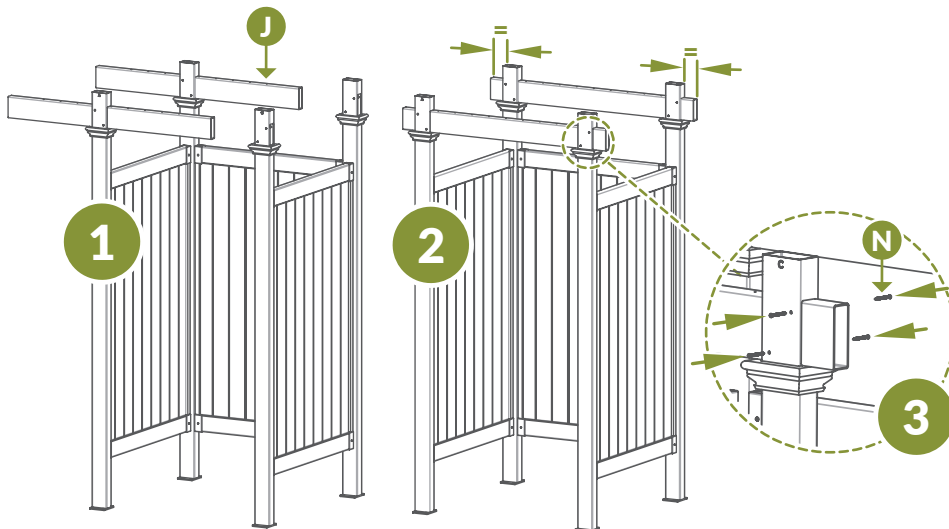

## STEP 7.3 ▶

1. Apply a small amount of Vinyl Glue (Q) to the inside rim of the Decorative End Caps (F).
2. Attach the decorative end caps to the ends of the beams.
3. Pressure fit (4) Post Caps (E) over the post.

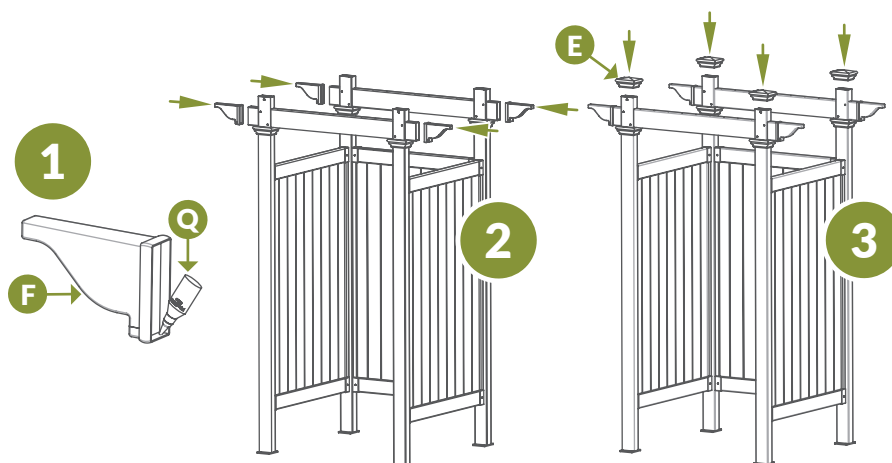

## STEP 8: SQUARE AND SECURE POSTS

### STEP 8.1

► Visually square the unit in the space where you plan to install your shower. The diagonal distance between your posts must be equal for your unit to be square.

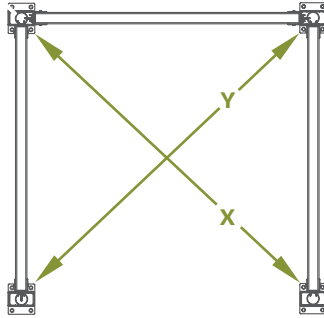

*Note: X and Y measurements must be equal for unit to be square*

### STEP 8.2a

#### ► Surface Mount Install:

1. Mark the hole locations for all 4 surface mounts.
2. Use  $\frac{1}{4}$ " x 3" concrete wedge anchors (not included) to secure the surface mounts or similar size lag screw if mounting on wood.

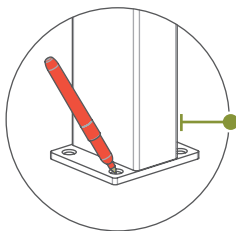

*Note: If your concrete is not level, insert galvanized steel washers under the lower side of the surface mount until it is level. Next, secure the surface mounts with wedge anchors.*

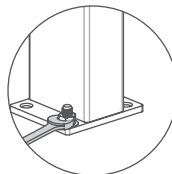
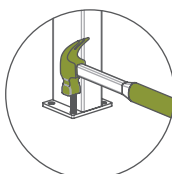
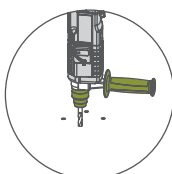

*A hammer drill will be needed for this step.*

### STEP 8.2b

#### ► Post Extension Install:

1. Mark the post locations and temporarily set the unit aside. Dig (4) 9" diameter holes, 36" deep, at the post locations.
2. Lower the unit into the ground and fill the holes with concrete (not included). Use support blocks to support the unit while the concrete cures.

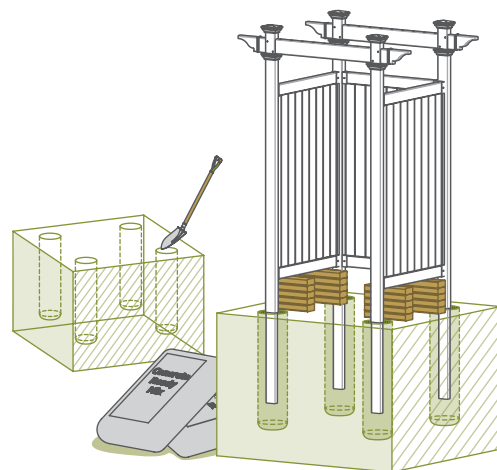

## STEP 9: INSTALL PRIVACY STRIPS

### STEP 9.1 ▶

1. Place (1) Privacy Strip (S) against the inside of post C as shown. The top of the privacy strip should be roughly 1½" below the horizontal rail.
2. Drive (6) 1¼" white self-drilling stainless steel screws through the pre-drilled holes in the privacy strip.
3. Repeat this process for post A.

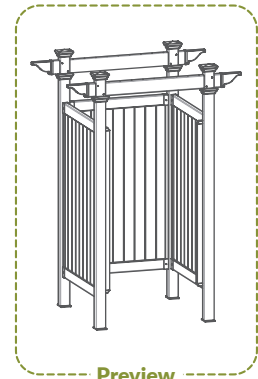
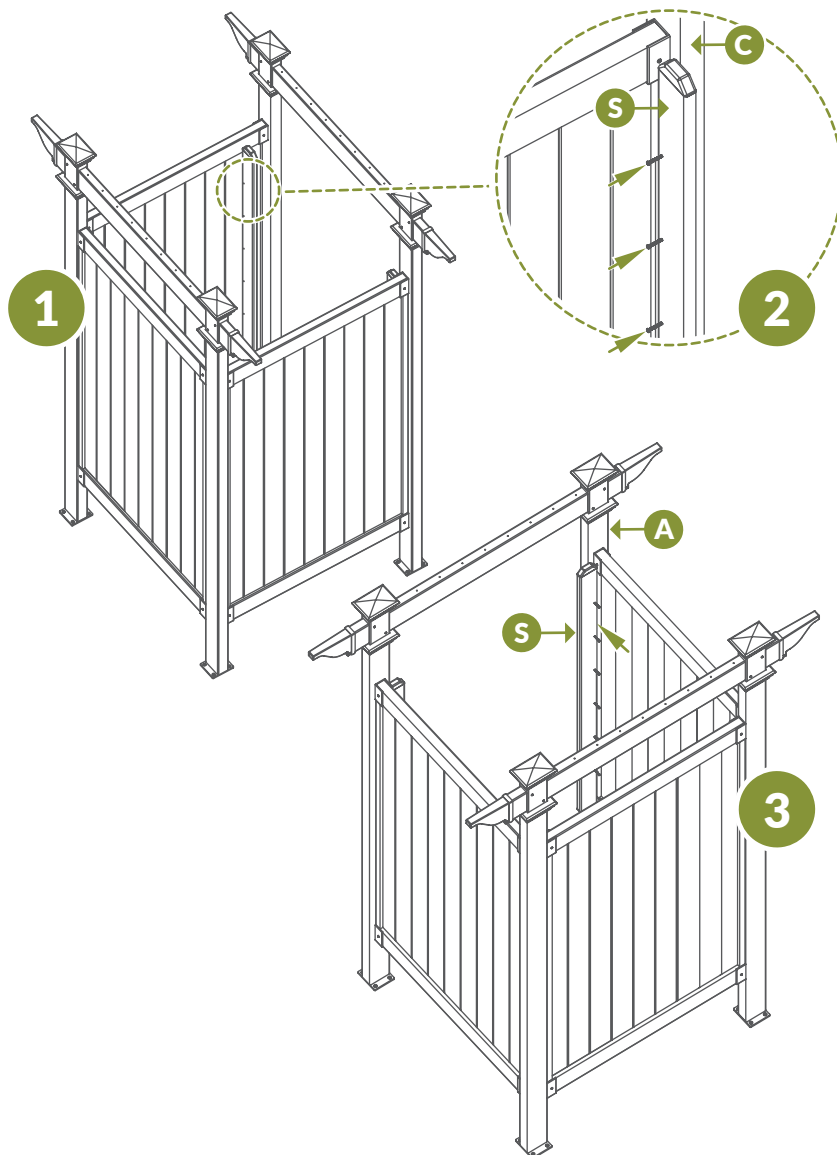

Preview

## STEP 10: ASSEMBLE SHOWER DOOR

### STEP 10.1

1. Insert (1) Door Horizontal Rail (**T**) into (2) Corner Brackets (**U**) until it hits the back wall.
2. Insert (2) Vertical Door Rails (**V**) into the corner brackets until they bottom out against the horizontal rail.

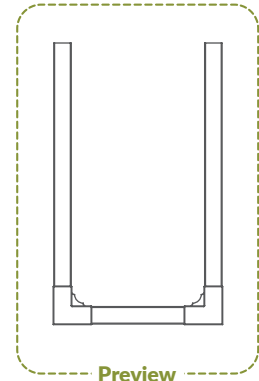
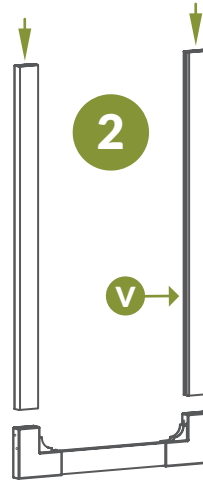
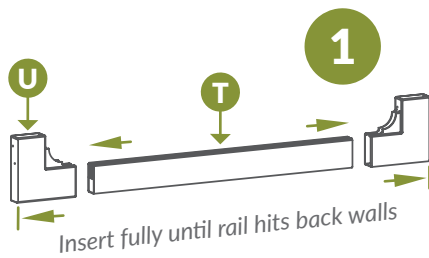

### STEP 10.2

1. Insert (1) privacy board into the vertical door rail down into the groove of the door horizontal rail.
2. Insert the Privacy Board-Narrow (**R**) into the opposite vertical door rail.
3. Slide the final privacy board between the two boards as shown.

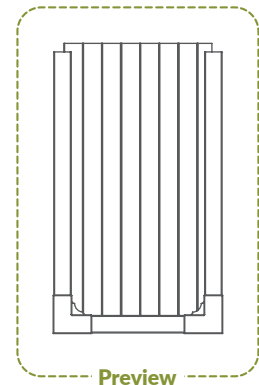
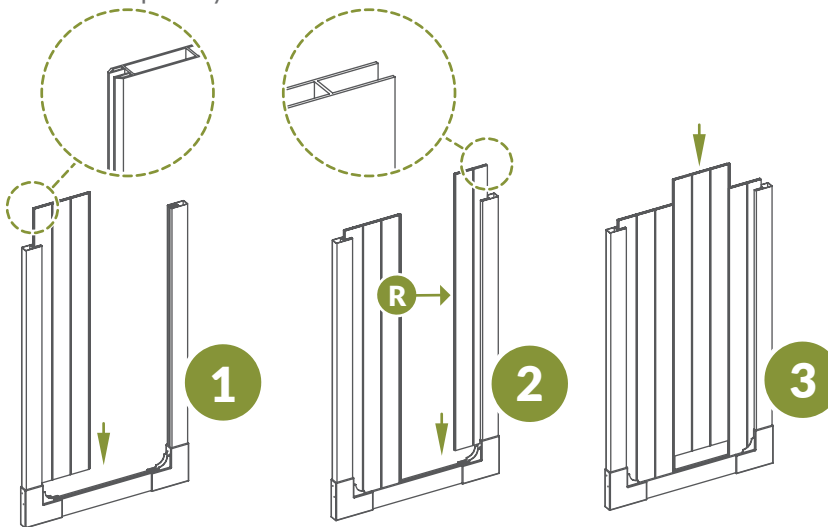



**STEP 10.3**

1. Assemble the top of the door frame the same as the bottom of the door frame.
2. Slide the top of the door frame over the vertical door rails.
3. Secure the corner brackets to the rails using (11) 1 ¼" white self-drilling stainless steel screws as shown.



1



2

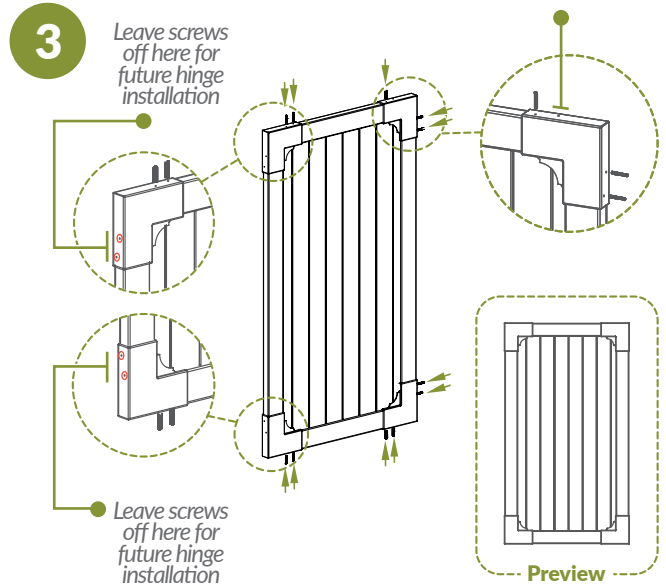

3

**STEP 10.4**

1. Assemble the Door Brace (**W**) by sliding the smaller door brace part 1 into the larger door brace part 2. Align the holes and secure with the ¾" bolts and nuts packaged with the gate brace.
2. Ensure that the door is square as shown below.
3. Screw the brace into place using the (4) screws packaged with the brace.

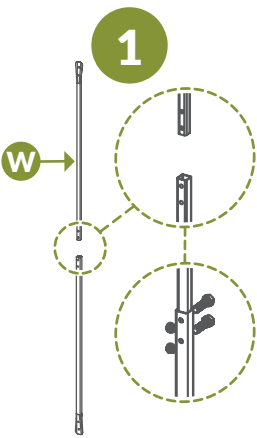

1

W

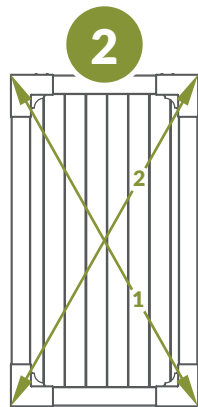

2

Top of door

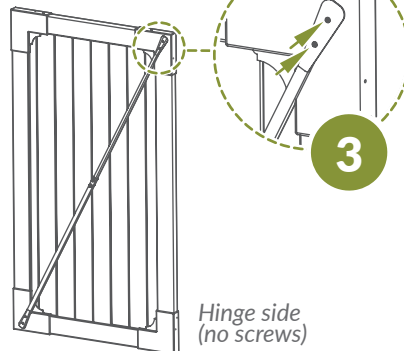

3

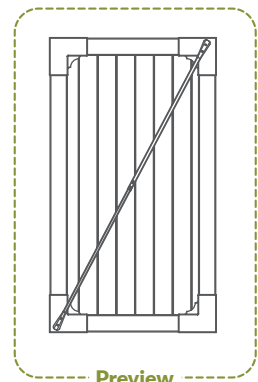

Preview

Note: Ensure measurements 1 and 2 are equal

## STEP 11: INSTALL SHOWER DOOR

### STEP 11.1 ▶

1. Secure the (2) Hinges (X) to the door with (8) 1¼" Black Self-Drilling Stainless Steel Screws (O) included with the hinge.
2. Fasten the Latch (Y) to the top of the door with (6) 1¼" black self-drilling stainless steel screws included with the latch.
3. Use temporary spacers to hold the door at the correct height during hinge installation in the next step.

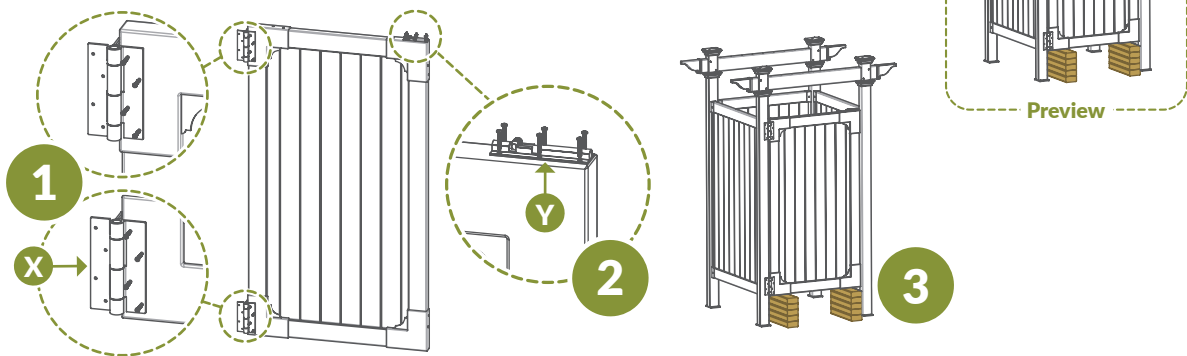

### STEP 11.2 ▶

1. Secure the hinges to the outside of post A with (8) 1¼" black self-drilling stainless steel screws.
2. Open the door and secure (16) 1¼" black self-drilling stainless steel screws through the pre-drilled holes on the inside of the hinges.

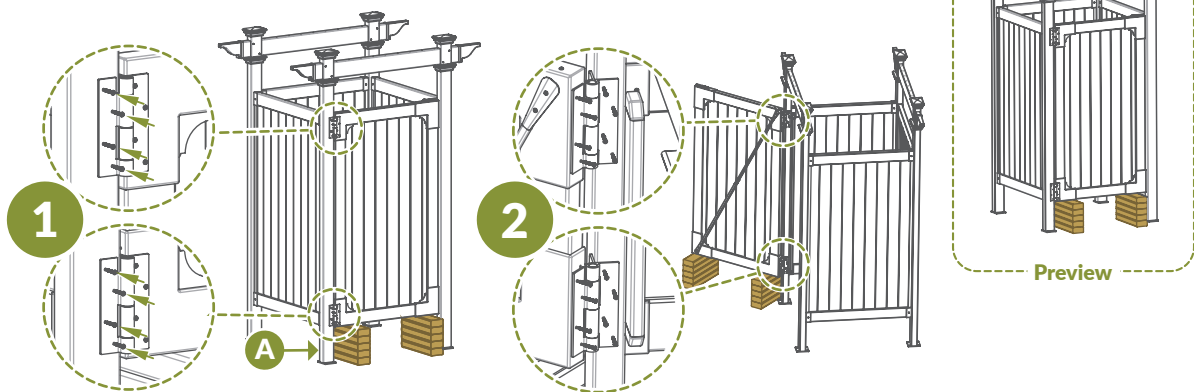

**STEP 11.3** ▶

1. Mark where the latch bolt meets the post on post C.
2. Drill a  $\frac{3}{8}$ " hole at the marked location to receive the latch bolt.

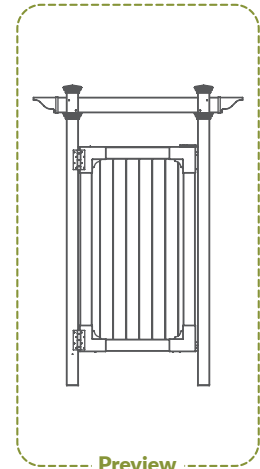
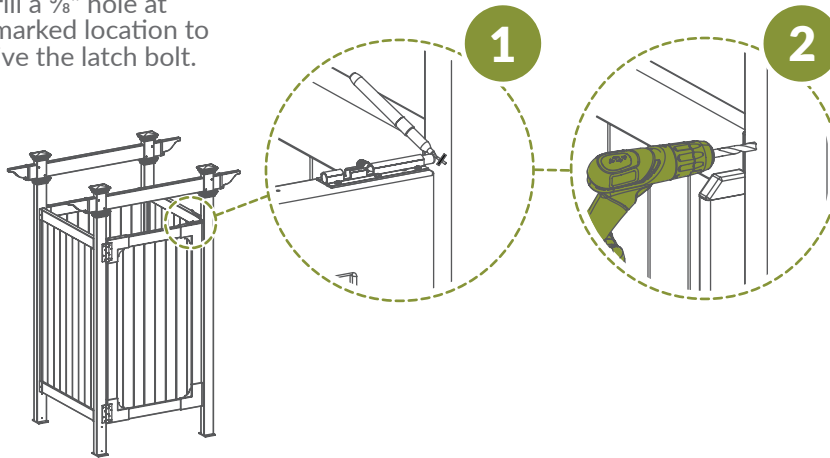
**STEP 12: INSTALL SHADE SLATS****STEP 12.1** ▶

1. Fasten (1)  $1\frac{1}{4}$ " white self-drilling stainless steel screw through the pre-drilled hole on both ends of the Shade Slat (H).
2. Place the screws in the shade slat on the top of the beams and fasten them into the pre-drilled holes on top of the beams.
3. Repeat this process with the remaining shade slats.

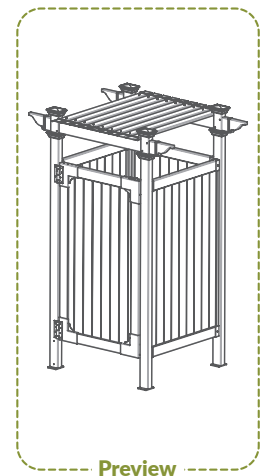
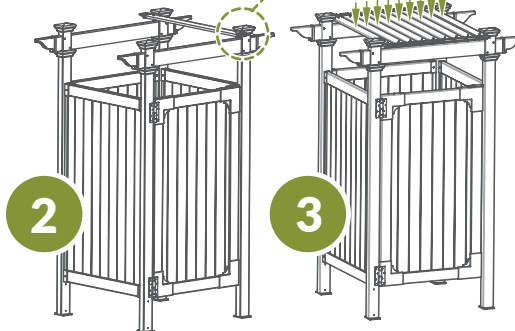
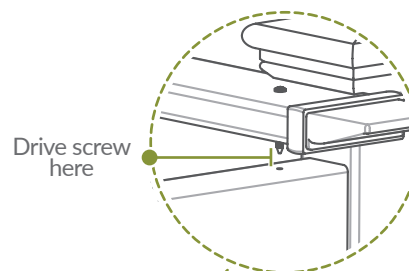
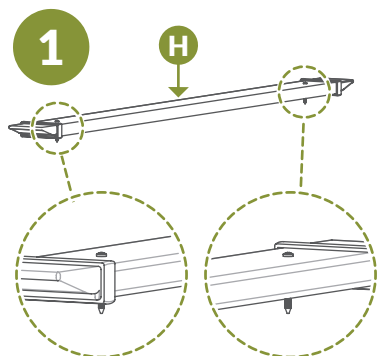



# ZIPPITY

*Easy Does It!*



6935 Reames Rd. Ste. K.  
Charlotte, NC 28216



[support@zippity-outdoor.com](mailto:support@zippity-outdoor.com)

704-892-5222  
877-234-6196



[WWW.ZIPPITY-OUTDOOR.COM](http://WWW.ZIPPITY-OUTDOOR.COM)