

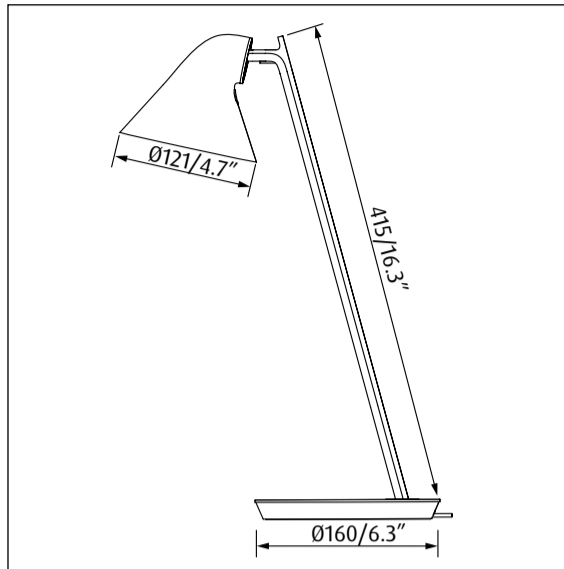





NJP Mini Table

louis
poulsen

Design nendo



Lyskilde Light source Leuchtmittel Ljuskälla Sorgenti luminose Source lumineuse Fuente de luz Valonlähde ランプ	Spænding/frekvens Voltage/frequency Spannung/frequenz Spänning/frekvens Tensione/frequenza Voltage/frequence Tensión/frecuencia Jännite/taajuus 電源電圧 / 周波数	Vægt Weight Gewicht Vikt Peso/ingombro Poids Peso Paino 質量	Isolationsklasse Protection class Schutzklasse Isolationsklass Classe di isolamento classe de protection clase de protección Eristysluokka 感電保護クラス	Tæthedsklasse Ingress protection Schutzart Kapslingsklass Grado di protezione Indice de protection Clase de protección Kotelointiluokka IPクラス
LED  	AC100-240V, 50/60HZ	Max. 2,9 kg/6.4 Lbs	Cl. II	IP20 / Dry location
LED  	DC 12V  SELV	Max. 2,9 kg/6.4 Lbs	Cl. III	IP20 / Dry location

DA
Støv aftørres med en tør, blød klud. Fedtpletter og lignende kan fjernes med en blød klud opvredet i lunkent vand (<50° C) tilsat mildt rengøringsmiddel.
Brug aldrig rengøringsmidler, der indeholder slibemiddel eller opløsningsmidler.

EN
Wipe off dust with a dry, soft cloth. Remove greasy spots etc. with a soft cloth dampened in lukewarm water (<50° C) with a mild detergent.
Never use detergents containing abrasives and solvents.

DE
Staub bitte mit einem trockenen, weichen Lappen abwischen. Fettflecke und dgl. mit einem feuchten, in lauwarmem Wasser (<50° C) mit mildem Reinigungsmittel ausgewrungenen Lappen entfernen.
Niemals Reinigungsmittel mit Schleifmittel oder Lösungsmittel verwenden.

SV
Lampan dammtorkas med en torr, mjuk trasa. Fettfläckar tas bort med ljummet vatten (<50° C) utblandat med mildt rengöringsmedel.
Använd aldrig rengöringsmedel som innehåller slipmedel eller lösningsmedel

IT
Pulire la polvere esterna con un panno morbido e asciutto. Rimuovere macchie di grasso ecc. con un panno morbido inumidito in acqua tiepida (<50° C) e con un detergente leggero.
Non usare mai detersivi contenenti abrasivi o solventi.

FR
Essuyez la poussière avec un chiffon sec et doux. Enlevez les points de saleté etc. avec un chiffon doux imprégné d'eau claire tiède et de détergent doux.
Ne jamais utiliser de détergents contenant des abrasifs et des solvants.

ES
Limpiar con paño seco y suave. Quitar manchas de grasa y otras con paño suave humedecido con agua templada (<50° C) con detergente poco agresivo.
Nunca use detergentes que contengan abrasivos y disolventes.

FI
Pyyhi pölyt kuivalla pehmeällä liinalla. Poista rasvatahrat miedolla pesuaineella ja haalealla vedellä (<50° C) kostutetulla pehmeällä liinalla.
Älä koskaan käytä liuottimia tai hankausaineita sisältäviä pesuaineita.

JP
ホコリは乾いた柔らかい布で拭き取ってください。塗装部分の油汚れ等は、中性洗剤を溶かしたぬるま湯(50℃以下)に柔らかい布を浸し、よくしぼってから拭き取ってください。シンナー・ベンジン等の揮発物や、つや出し剤・研磨剤は使用しないでください。



Replaceability & Energy Efficiency Class

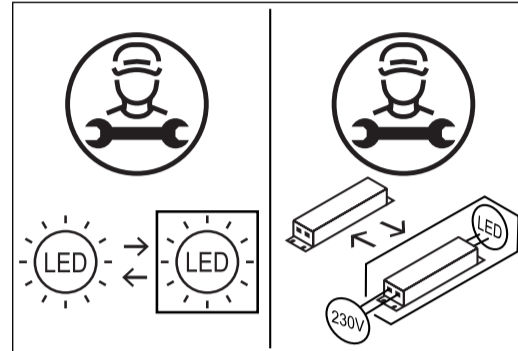

DA
Dette produkt indeholder en lyskilde i energieffektivitetsklasse F

EN
This product contains a light source of energy efficiency class F

DE
Dieses Produkt enthält eine Lichtquelle der Energieeffizienzklasse F

SV
Denna produkt innehåller en ljuskälla med energieffektivitetsklass F

IT
Questo prodotto contiene una sorgente luminosa di classe di efficienza energetica F

FR
Ce produit contient une source lumineuse de classe d'efficacité énergétique F

ES
Este producto contiene una fuente luminosa de la clase de eficiencia energética F

FI
Tämä tuote sisältää valonlähteen, jonka energiatehokkuusluokka on F

JP
この製品には、エネルギー効率クラスFの光源が含まれています



SV
Ljuskällan i denna armatur ska endast bytas ut av tillverkaren eller en kvalificerad elektriker.
Om den externa flexibla ledningen till armaturen skadas ska den endast bytas ut av tillverkaren eller dennes servicerepresentant eller liknande kvalificerad person för att undvika fara.



IT
La sorgente contenuta in questa parte illuminante sarà solo riposizionata dal produttore o da un elettricista esperto.
Se il cavo esterno flessibile dell'apparecchio è danneggiato, dovrà essere sostituito esclusivamente dal produttore, dal servizio assistenza o da personale qualificato per evitare qualsiasi pericolo.



FR
La source lumineuse de ce luminaire ne peut être remplacée que par le fabricant ou un électricien qualifié.
Si le cordon ou le câble flexible externe de ce luminaire est endommagé, il doit être exclusivement remplacé par le fabricant, son représentant ou une personne qualifiée afin d'éviter tout danger.



ES
La sustitución de la fuente de luz que contiene esta luminaria debe ser llevada a cabo exclusivamente por el fabricante o un electricista profesional.
Si el cable flexible externo de esta luminaria se dañara, debería ser reemplazado únicamente por el fabricante, o por su agente autorizado, o por una persona cualificada para así evitar peligros.



FI
Tämän valaisimen valonlähteen saa vaihtaa ainoastaan valmistaja tai koulutettu sähköasentaja.
Vaaratilanteiden välttämiseksi valaisimen vahingoittuneen ulkoisen joustavan kaapelin tai johdon saa vaihtaa vain valmistaja, valtuutettu huoltoliike tai vastaava pätevä taho.



JP
この照明器具のLEDは、一般のランプのように取り換えができません。不点の場合は当社にお問い合わせください。
照明器具は、長時間の凝視が行われるように配置する必要があります
6,74m以上の距離での照明器具は期待できません
この照明器具のLEDは、一般のランプのように取り換えができません。不点の場合は当社にお問い合わせください。



DA
Lyskilden i dette armatur må kun udskiftes af producenten eller en uddannet elektriker.
Hvis den eksterne fleksible ledning eller kablet til dette armatur beskadiges, skal det udskiftes af producenten, dennes servicerepræsentant eller en person med tilsvarende kvalifikationer for at undgå farlige situationer.



EN
The light source contained in this luminaire shall only be replaced by the manufacturer or a qualified electrician.
If the external flexible cable or cord of this luminaire is damaged, it must only be replaced by the manufacturer or his service agent or a similar qualified person in order to avoid hazardous situations.



DE
Das in dieser Leuchte enthaltene Leuchtmittel sollte nur vom Hersteller oder von einem qualifizierten Elektriker ausgetauscht werden.
Im Fall einer Beschädigung des externen flexiblen Leuchtenkabels darf der Austausch des Kabels aus Sicherheitsgründen ausschließlich durch den Hersteller oder eine vom Hersteller benannte Servicestelle oder eine Fachkraft mit geeigneter Qualifikation erfolgen.

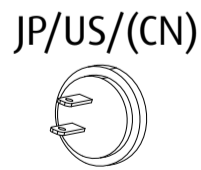
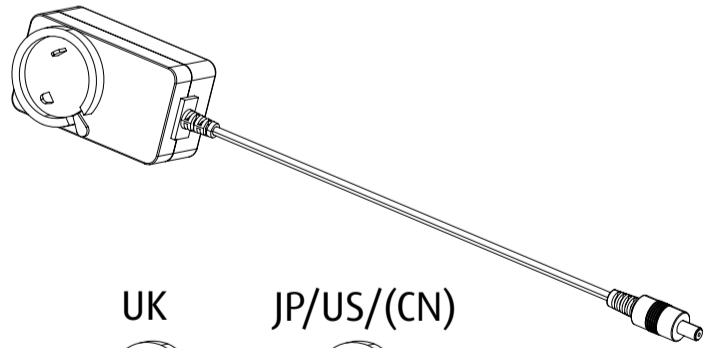
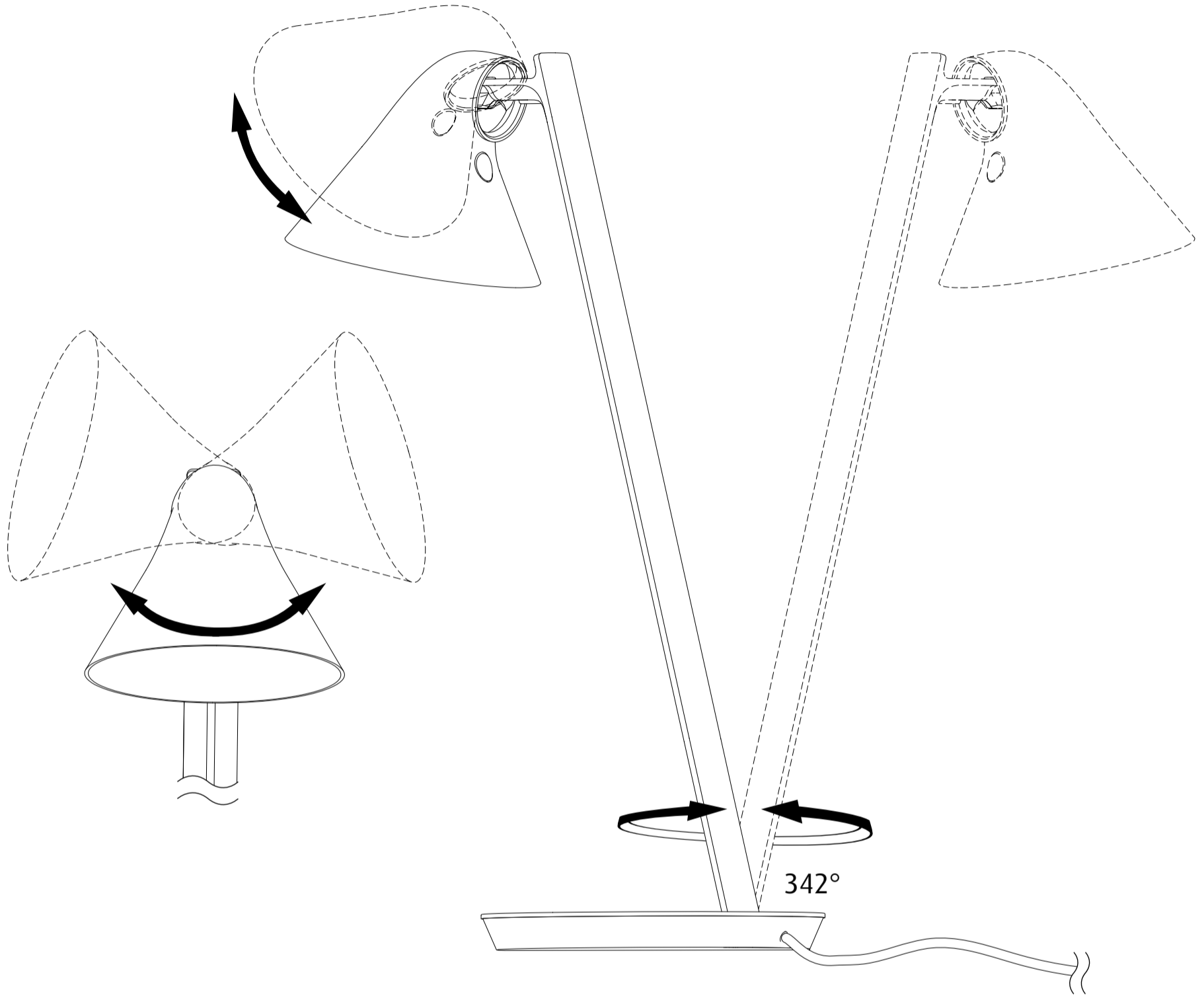
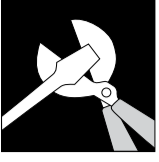

NJP Mini - Electronic Functions

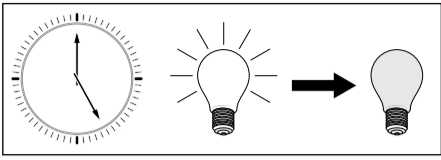

B Timing Function (User Function)

Set timer to automatically turn off after period of time

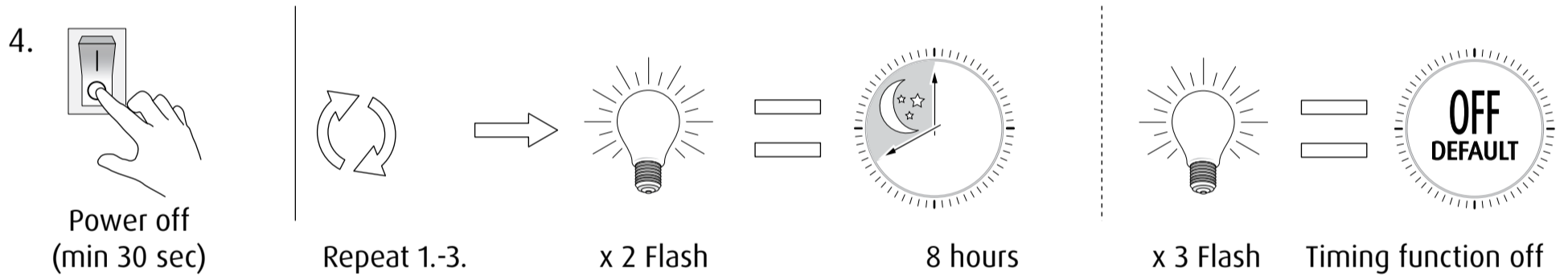
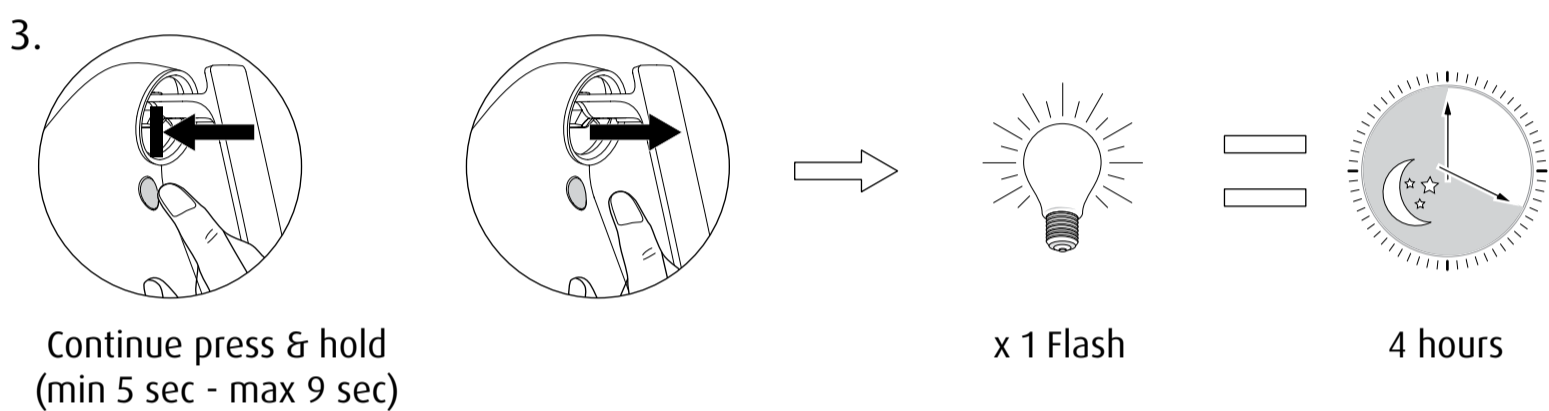
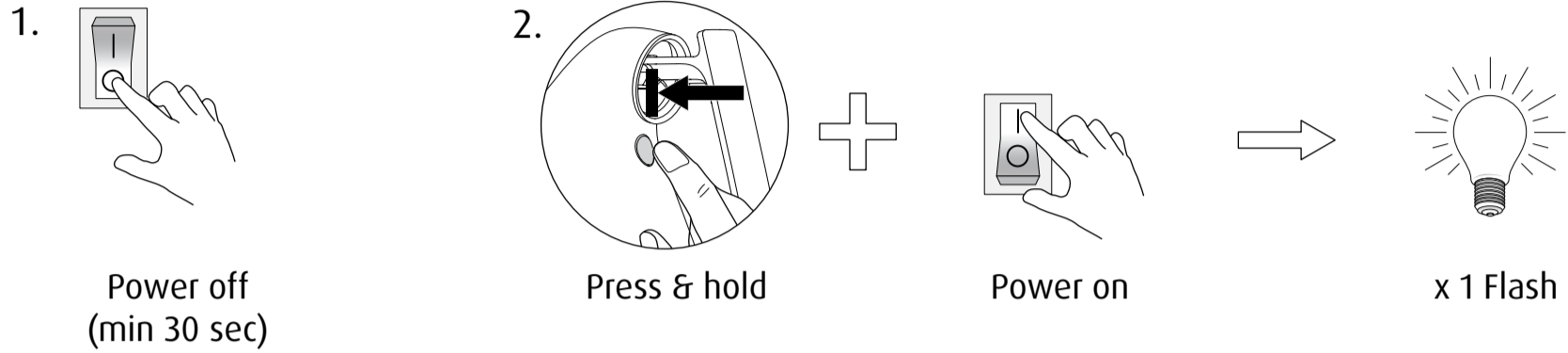

Restore factory default settings:

This is the standard setting for this product.

With this setting the on/off button and dimming function is active.

