

WHITE : BLANC : *BLANCO*

OAK BARREL : FÛT DE CHÊNE : *BARRIL DE ROBLE*

BARK GREY : GRIS ÉCORCE : *CORTEZA GRIS*

COGNAC CHERRY : CERISIER COGNAC : *CEREZO COÑAC*



► PARTS / PIÈCES / PIEZAS

CODE / CÓDIGO	QTY / QTÉ / CANT.	CODE / CÓDIGO	QTY / QTÉ / CANT.	CODE / CÓDIGO	QTY / QTÉ / CANT.	CODE / CÓDIGO	QTY / QTÉ / CANT.
CA01A	2	20	1	42	1	Bottom / Fond / Fondo 32 1/2" x 15 3/8" (823 mm x 391 mm)	2
CL09A	2	30	1	43	1		
CL81B	1	31	1	66	1		
05	2	40	1	67	1		
13	2	41	1	70	1		



two people are required to assemble and move this model.
deux personnes sont requises pour assembler et déplacer ce modèle.
se necesitan dos personas para ensamblar y desplazar este mueble.

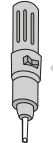







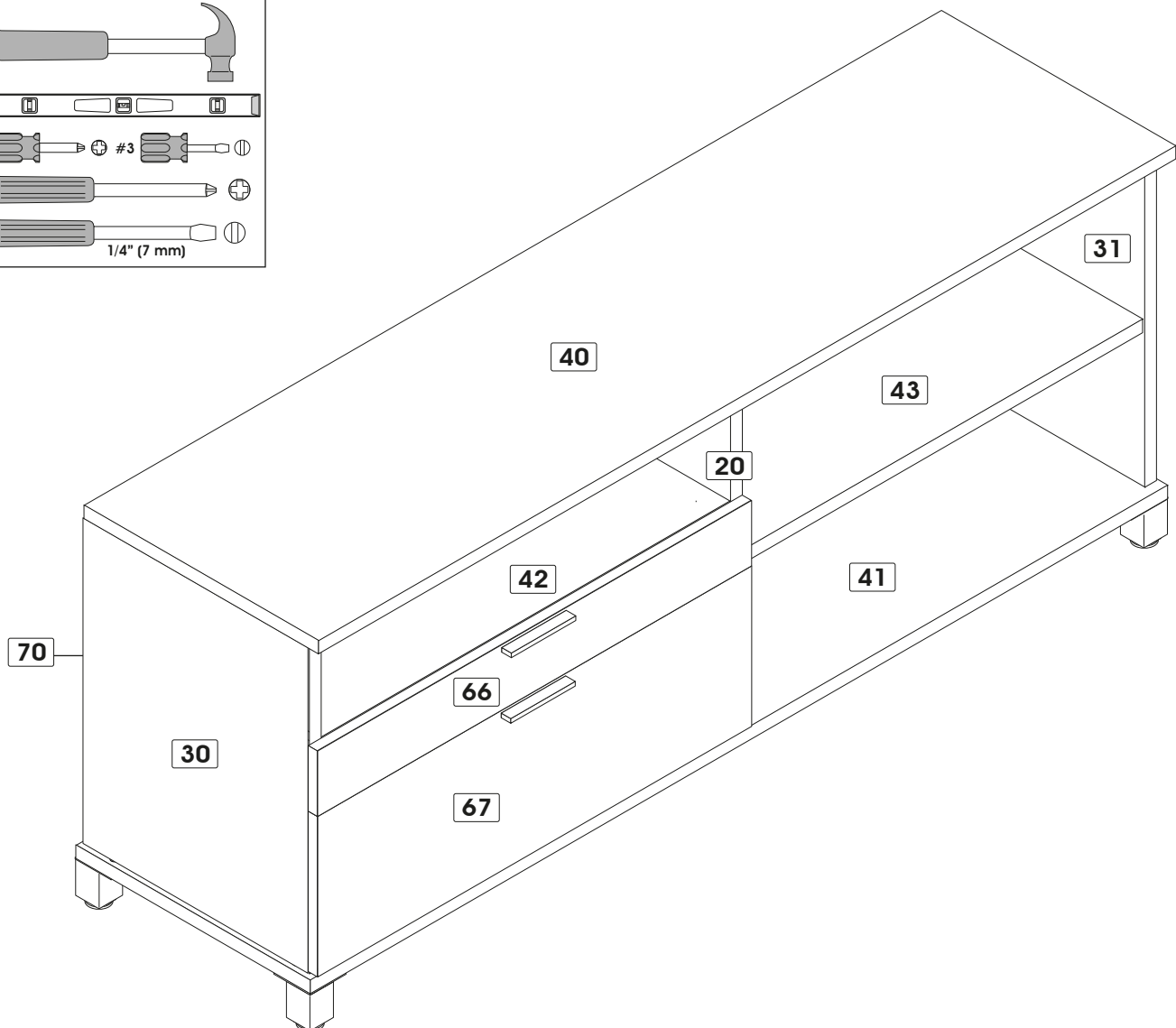



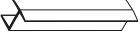
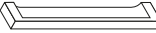

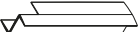





the use of electric tools must be made with vigilance.
l'utilisation d'outils électriques doit être faite avec vigilance.
las herramientas eléctricas deben utilizarse con sumo cuidado.

tools required
outils requis
herramientas necesarias

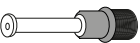
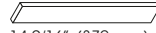

1/4" (7 mm)



HARDWARES / QUINCAILLERIES / QUINCALLAS

CODE / CÓDIGO	QTY / QTÉ / CANT.	CODE / CÓDIGO	QTY / QTÉ / CANT.	CODE / CÓDIGO	QTY / QTÉ / CANT.	CODE / CÓDIGO	QTY / QTÉ / CANT.
CA-864 	12	EX-681  31 7/8" (809 mm)	2	PO-572 	2	VF-230  5/8" (16 mm)	4
CA-99 	12	EX-702  16 3/16" (411 mm)	2	ST-614 	4	VM-601  3/4" (20 mm)	6
CL-745 	1	H-03 	20	SU-682 	4	VP-217  5/8" (16 mm)	4
CO-249 runners 406 mm (16") coulisseaux 406 mm correderas 406 mm	2	H-04 	4	TI-452 	4	VR-207  1/2" (13 mm)	12
E-27 	5	H-36 	16	TI-703  14 9/16" (370 mm)	2	VR-210  5/8" (16 mm)	15
EC-744 	6	PA-947 	5	VE-244  3/8" (10 mm)	12	VR-212  1" (25 mm)	20

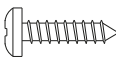
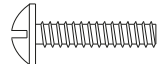
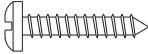
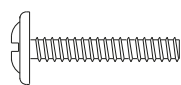
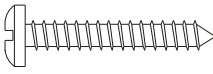
REAL SIZE / GRANDEUR RÉELLE / TAMAÑO REAL

CODE / CÓDIGO	QTY / QTÉ / CANT.	CODE / CÓDIGO	QTY / QTÉ / CANT.
VE-244  3/8" (10 mm)	12	VR-207  1/2" (13 mm)	12
VF-230  5/8" (16 mm)	4	VR-210  5/8" (16 mm)	15
VM-601  3/4" (20 mm)	6	VR-212  1" (25 mm)	20
VP-217  5/8" (16 mm)	4		

IMPORTANT NOTICE / NOTE IMPORTANTE / NOTA IMPORTANTE

Group together all the hardware required for each step as the construction of your piece of furniture is progressing.

Regroupez toutes les quincailleries requises pour chaque étape de façon à vous assurer de tout installer au bon moment.

Reúna todas las quincallas necesarias para cada una de las etapas de montaje, para asegurar una correcta instalación en el momento adecuado.

▶ IMPORTANT NOTICE / NOTE IMPORTANTE / NOTA IMPORTANTE

Duly complete the self-adhesive sticker. / Assurez-vous de bien remplir l'autocollant. / Asegúrese de completar correctamente la etiqueta.

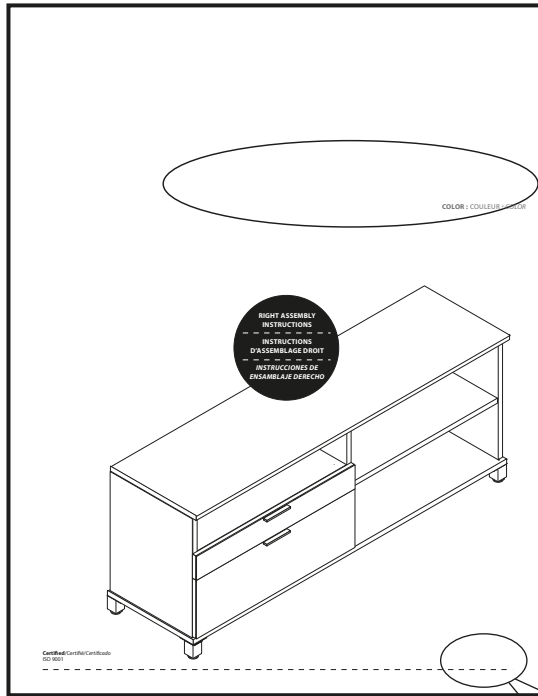

To better serve you!
Pour mieux vous servir!

Model / Modèle: _____

Production Number
Numéro de production: _____

Customer Service
Service à la clientèle

Important/Importante

Please retain the self-adhesive sticker which you will find at step 9 of the instruction manual.

Conservez l'autocollant qui sera collé seulement à l'étape 9 du feuillet d'instructions.

Conserve la etiqueta que será pegada sólo en la etapa 9 de la hoja de instrucciones.

▶ IMPORTANT NOTICE / NOTE IMPORTANTE / NOTA IMPORTANTE

▶ Main hardware system / Système de quincaillerie principal / Sistema principal de quincalla

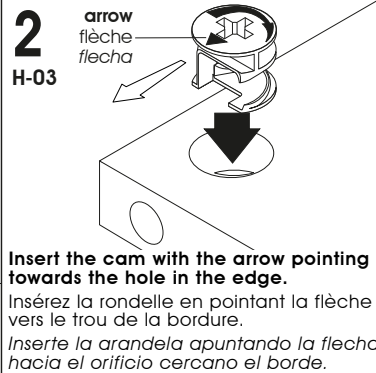
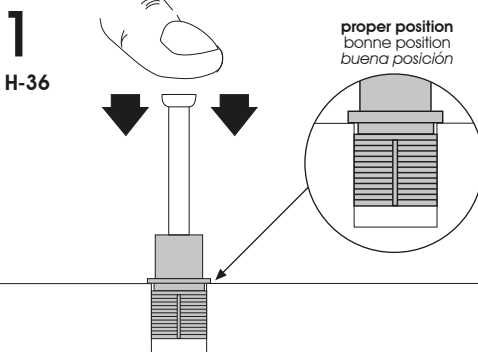

If needed / En cas de nécessité
En caso de necesidad

How to remove a misplaced assembly bolt (H-36).
Comment retirer un boulon (H-36) mal situé.
Cómo retirar un perno (H-36) mal ubicado.

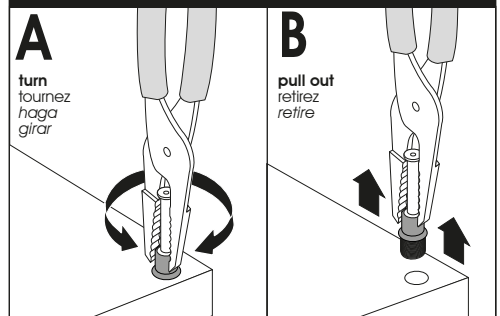

1 **HARDWARE INSTALLATION / INSTALLATION DES QUINCAILLERIES / INSTALACIÓN DE LAS QUINCALLAS**

Credenza / Crédence / Credencia

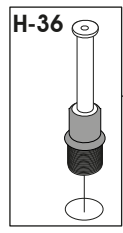
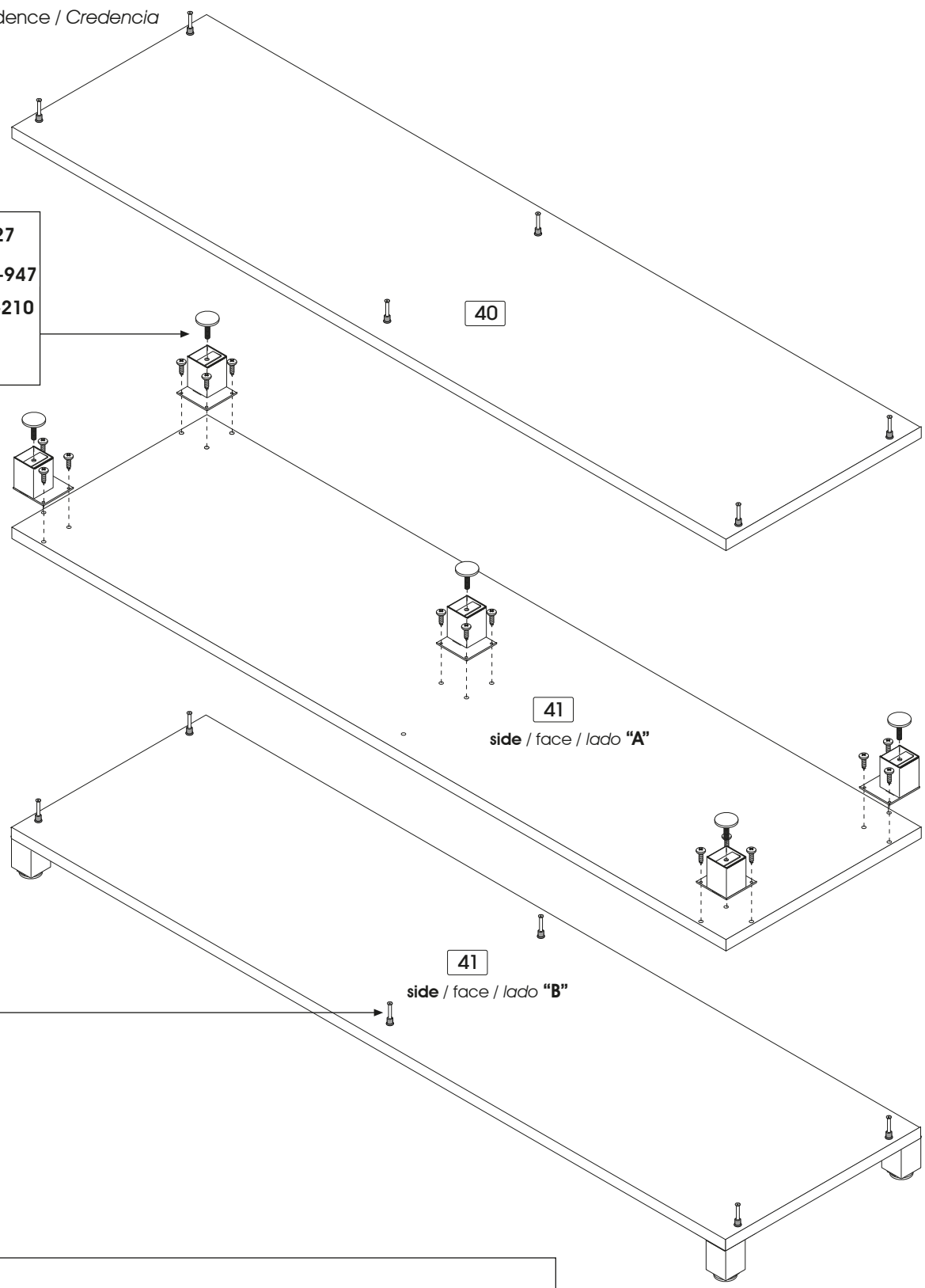
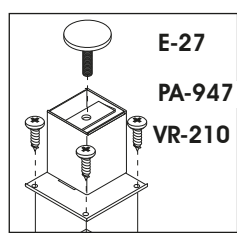

Code / Código	H-36	PA-947	E-27	VR-210
Qty / Qté / Cant.	x 12	x 5	x 5	x 15

2 HARDWARE INSTALLATION / INSTALLATION DES QUINCAILLERIES / INSTALACIÓN DE LAS QUINCALLAS

Credenza / Crédence / Credencia

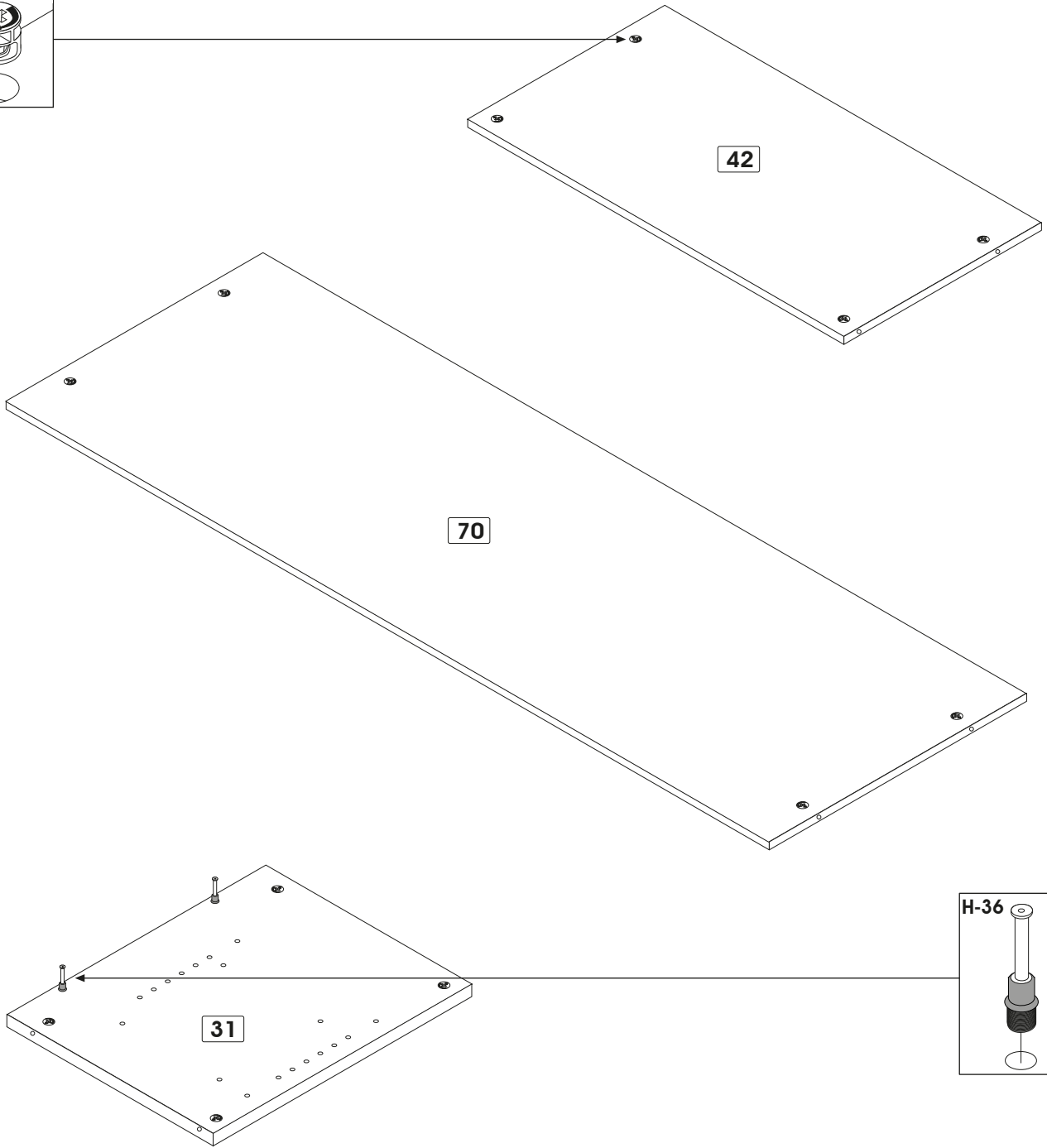
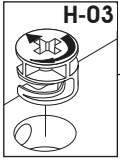

2



H-03

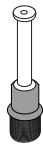

H-36

Code / Código

Qty / Qté / Cant.

x 12

x 2

3 HARDWARE INSTALLATION / INSTALLATION DES QUINCAILLERIES / INSTALACIÓN DE LAS QUINCALLAS

Credenza / Crédence / Credencia

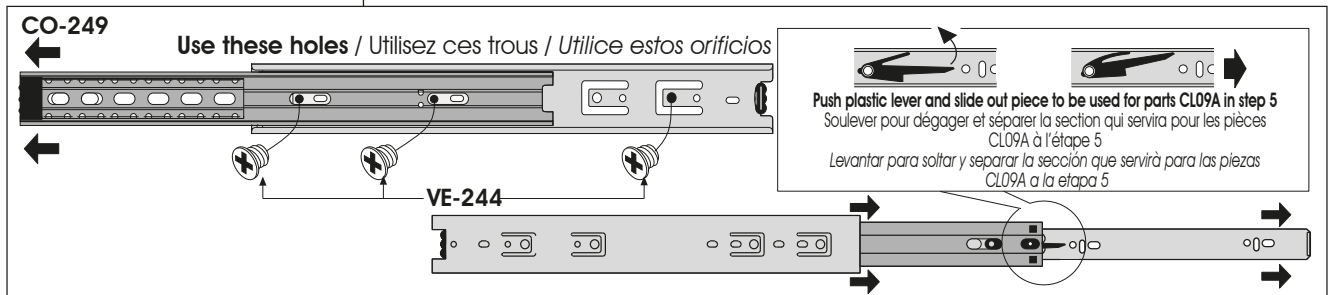
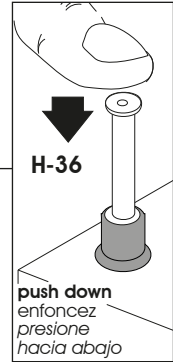
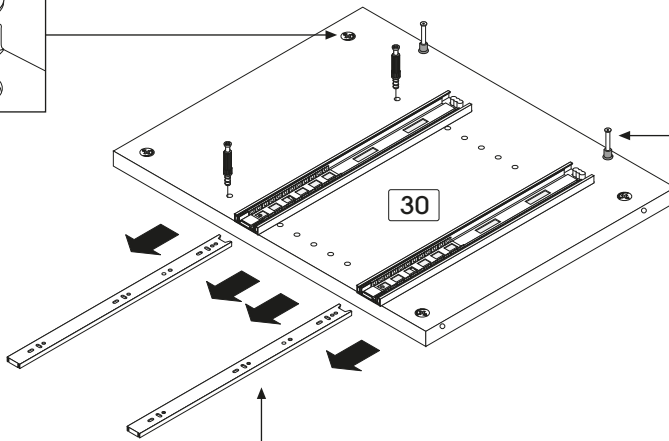
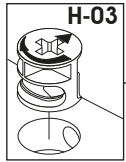
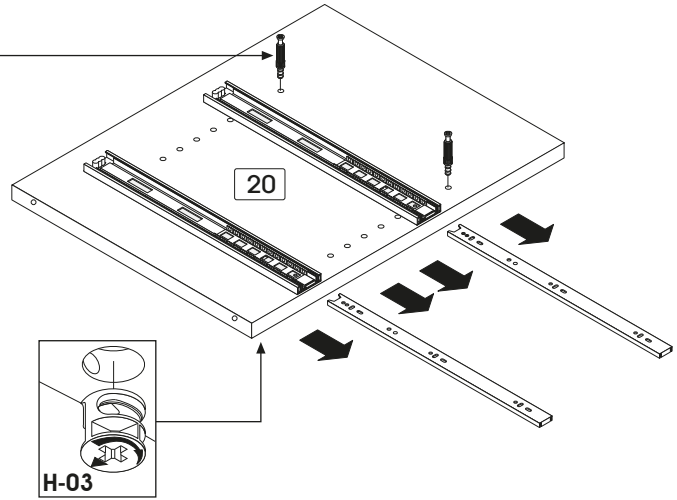
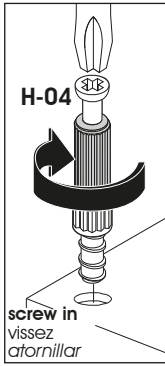

Code / Código	H-03	H-36	H-04	VE-244	CO-249
Qty / Qté / Cant.	x 8	x 2	x 4	x 12	x 2

IMPORTANT NOTICE / NOTE IMPORTANTE / NOTA IMPORTANTE

► **Main hardware system / Système de quincaillerie principal / Sistema principal de quincalla**

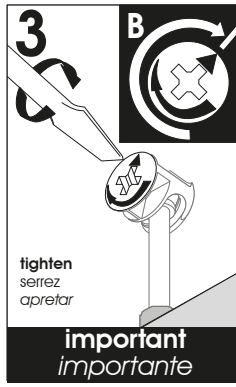
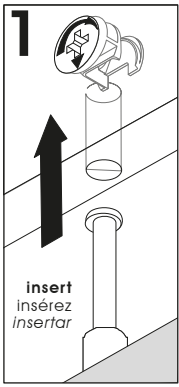

Make sure to properly tighten each cam to ensure furniture solidity. Otherwise, parts could be damaged or the user could be injured.

Assurez-vous de bien resserrer chaque rondelle pour assurer la solidité du meuble. Dans le cas contraire, des pièces pourraient être endommagées ou l'utilisateur pourrait se blesser.

Asegúrese de apretar bien cada arandela para garantizar la solidez del mueble. De lo contrario, podría provocarse daño a las piezas o las personas.

4 ASSEMBLY / ASSEMBLAGE / ENSAMBLAJE

Credenza / Crédence / Credencia

Assemble on the back edge

Assemblez sur la bordure arrière

Realice el ensamblaje sobre el borde trasero

Assembling sequence

Séquence d'assemblage

Secuencia de ensamblaje

Parts / Pièces / Piezas:

70 31 30 42 20 40 41

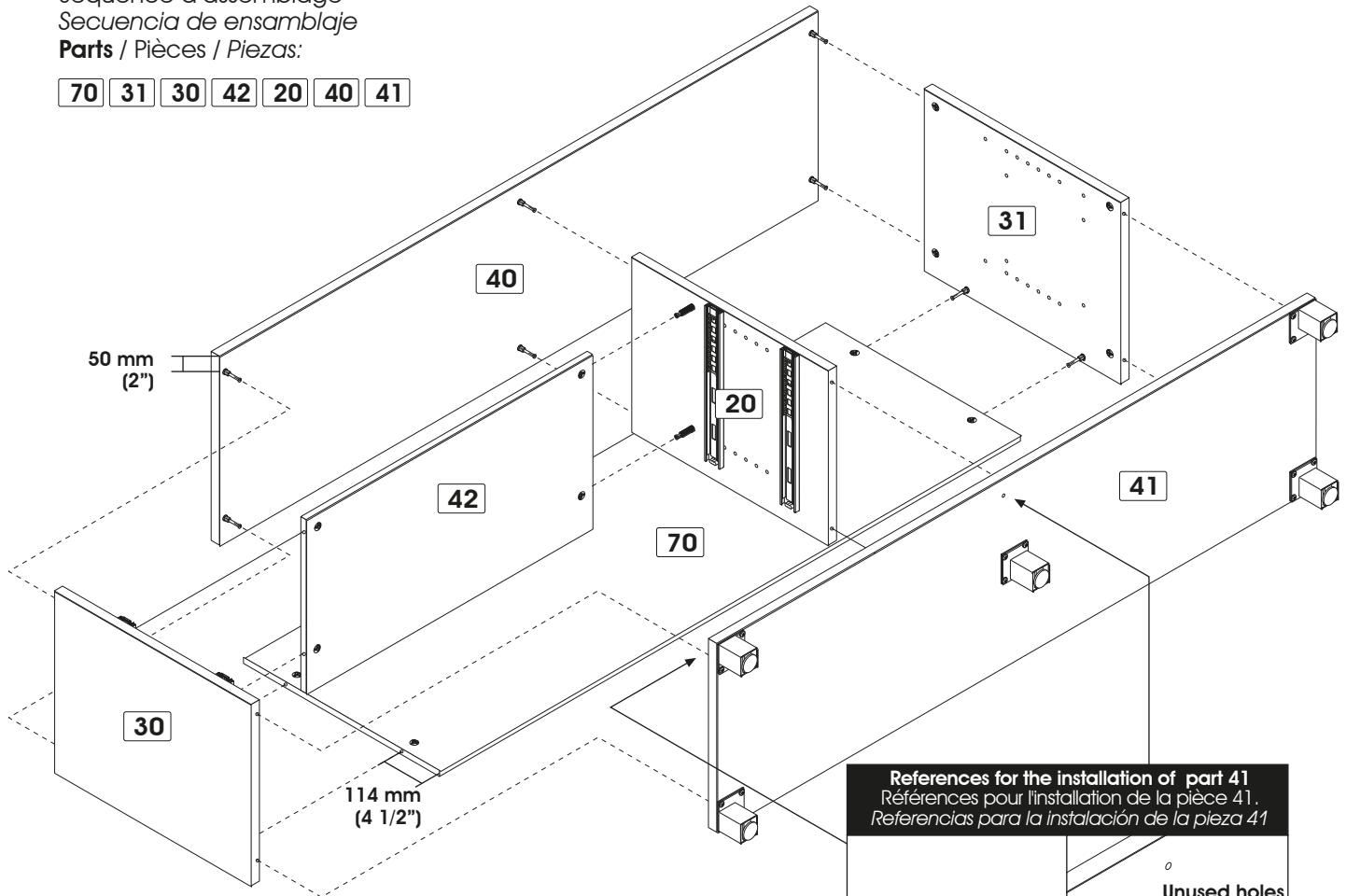

References for the installation of part 41
Références pour l'installation de la pièce 41.
Referencias para la instalación de la pieza 41

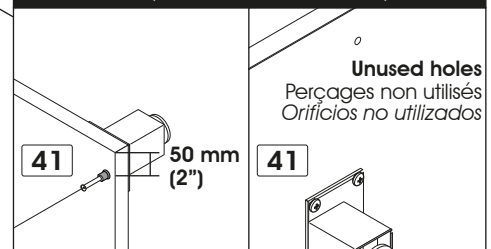

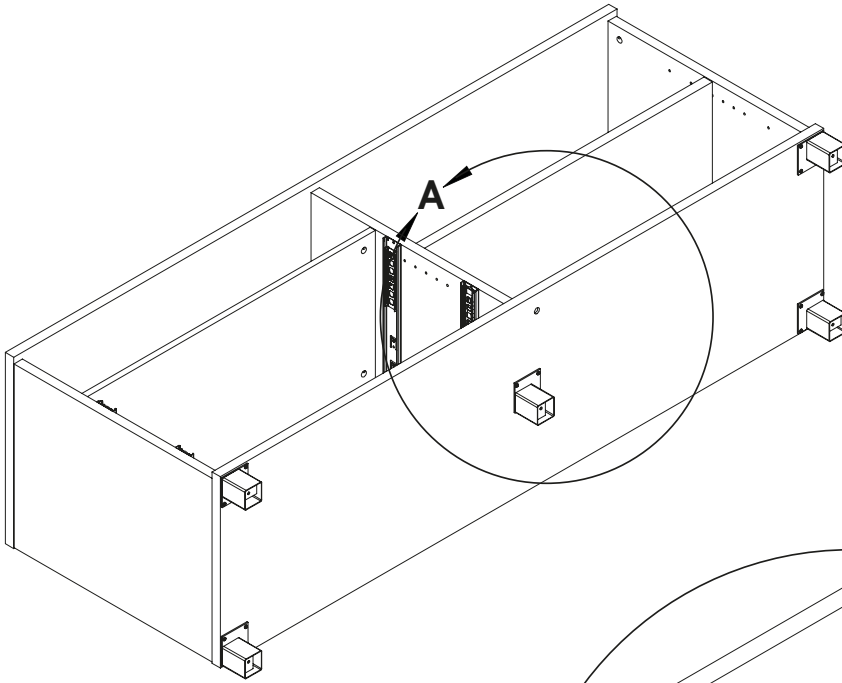

It is very important to put this hole in the front.
Très important de mettre ce trou à l'avant.
Es muy importante poner ese agujero en la parte delantera.

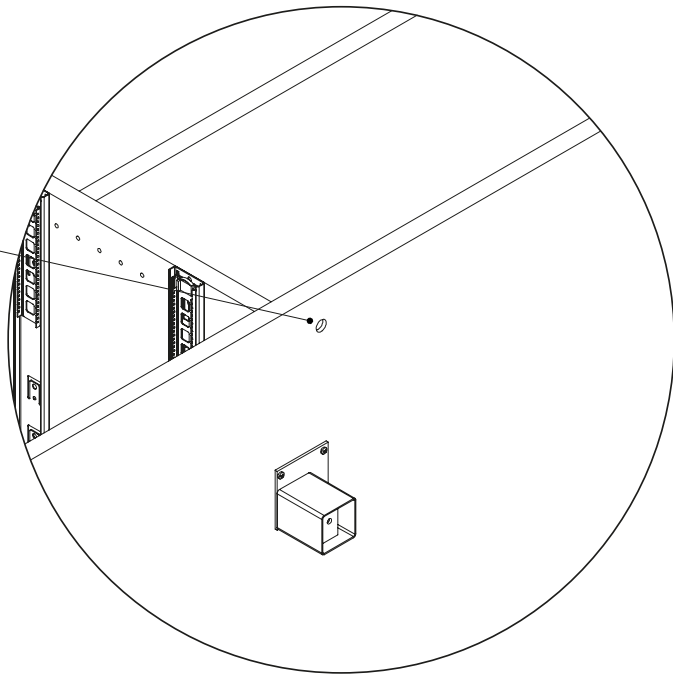

6 HARDWARE INSTALLATION / INSTALLATION DES QUINCAILLERIES / INSTALACIÓN DE LAS QUINCALLAS

Drawers / Tiroirs / Cajónes

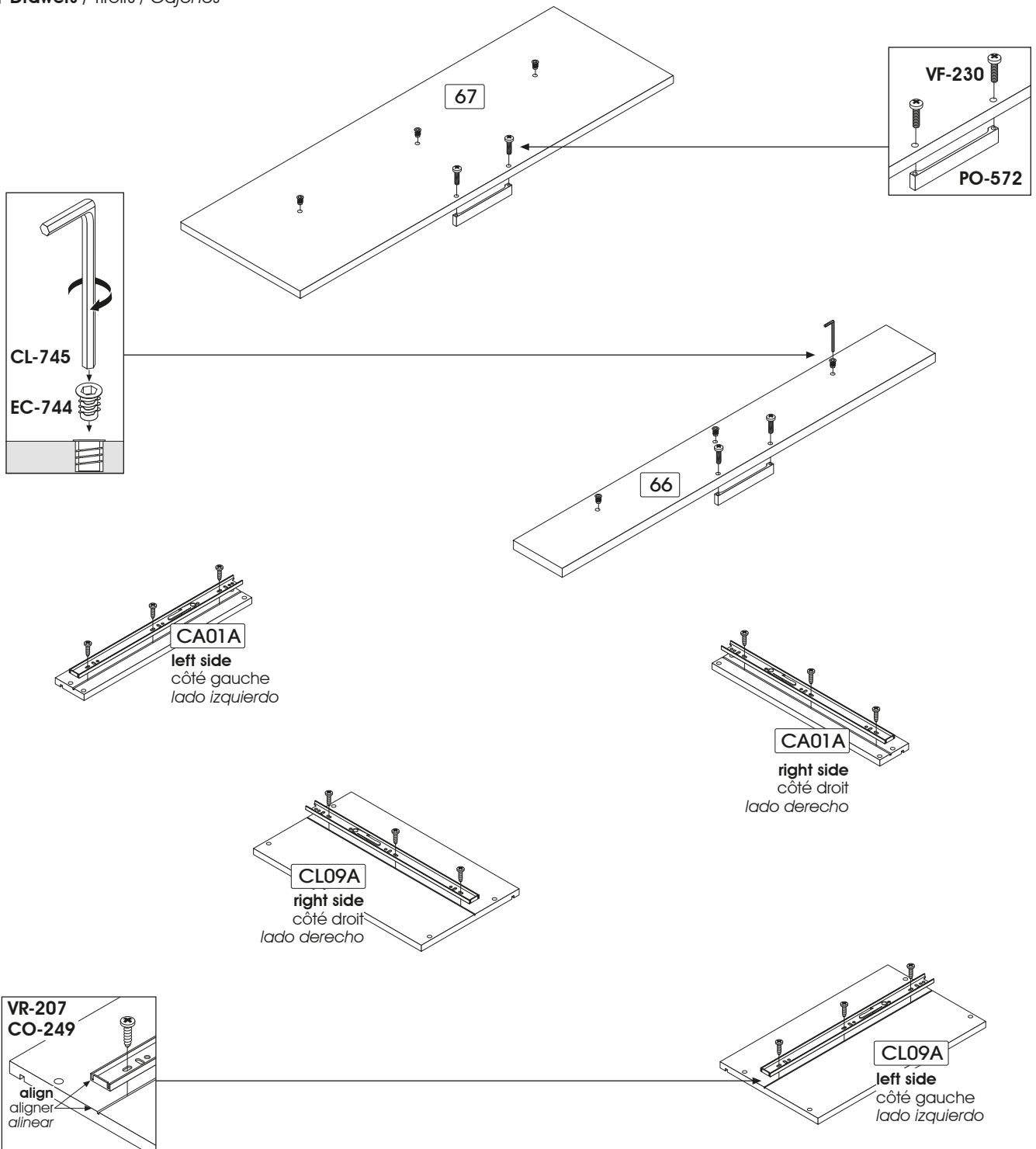

6

Code / Código	EC-744	CL-745	PO-572	CO-249	VR-207	VF-230
Qty / Qté / Cant.	x 6	x 1	x 2	x 2	x 12	x 4

Assembling sequence
 Séquence d'assemblage
 Secuencia de ensamblaje
Parts / Pièces / Piezas:

05 CA01A CA01A **bottom / fond / fondo** 05 66

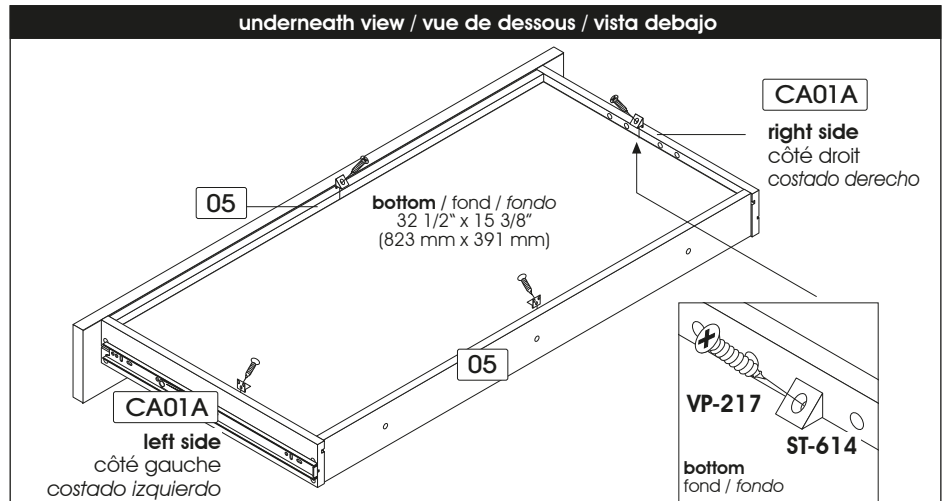
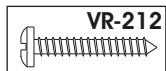
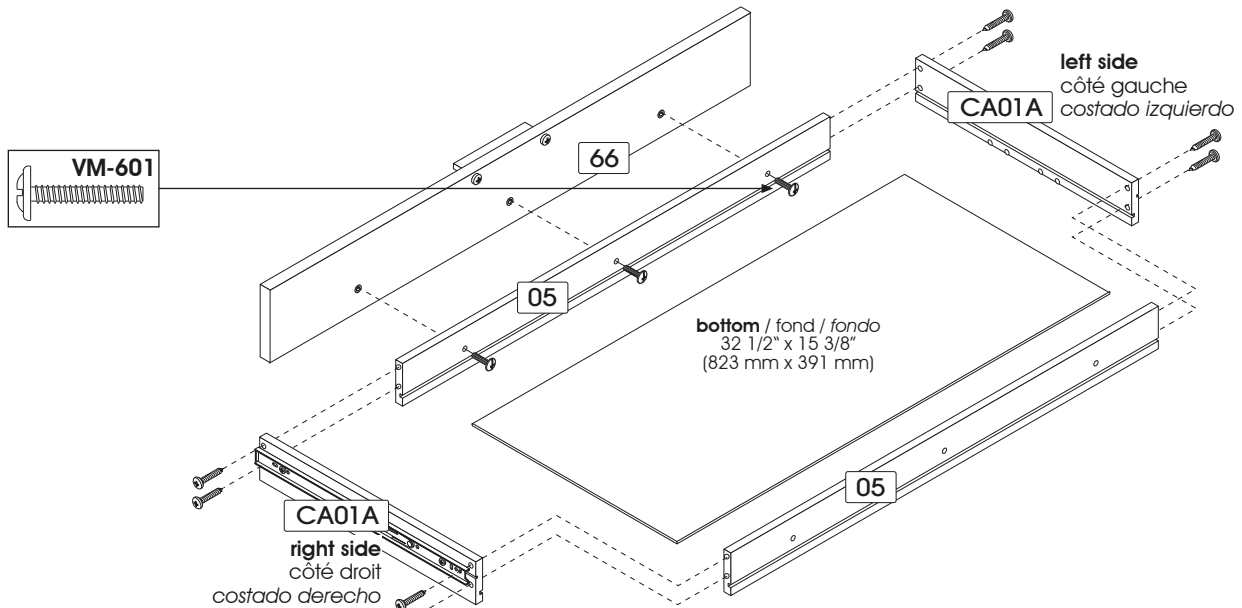

Code / Código	ST-614	VM-601	VR-212	VP-217
Qty / Qté / Cant.	x 4	x 3	x 8	x 4

Assembling sequence
 Séquence d'assemblage
 Secuencia de ensamblaje
Parts / Pièces / Piezas:

13 EX-681 + **CL09A** **CL09A**

bottom / fond / fondo + **13** **CL81B** **67**

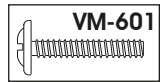
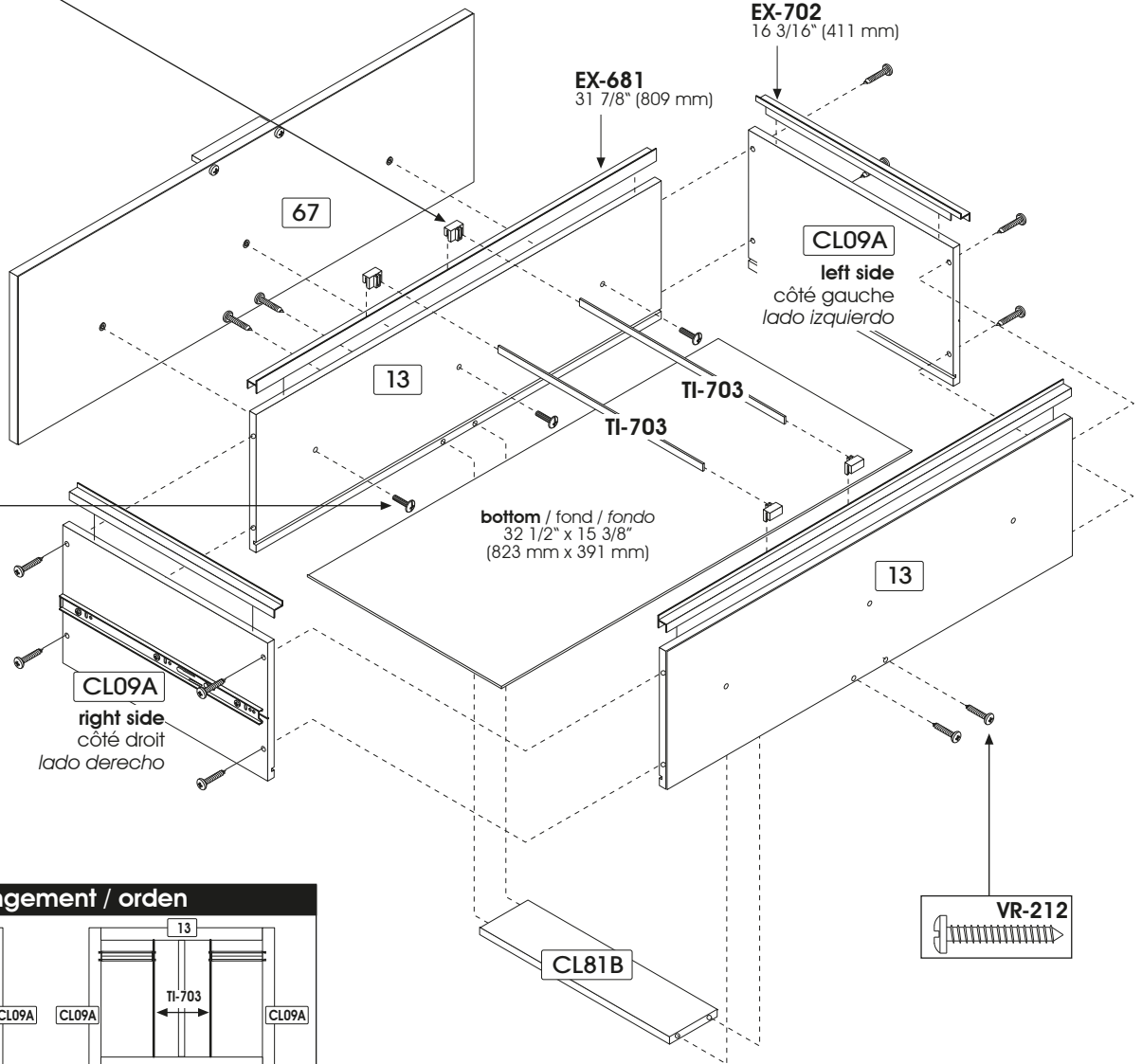
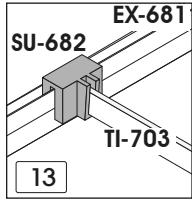

CL09A
right side
 côté droit
 lado derecho

EX-702
 16 3/16" (411 mm)

CL09A
left side
 côté gauche
 lado izquierdo

bottom / fond / fondo
 32 1/2" x 15 3/8"
 (823 mm x 391 mm)

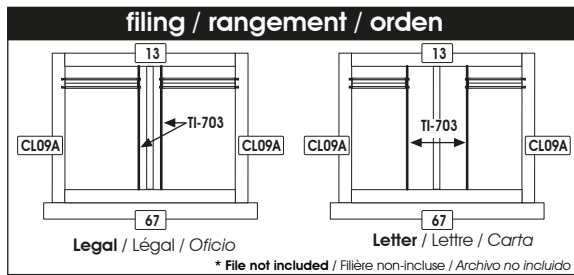
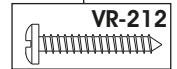

Code / Código	SU-682	EX-681	EX-702	TI-703	VM-601	VR-212
Qty / Qté / Cant.	x 4	x 2	x 2	x 2	x 3	x 12

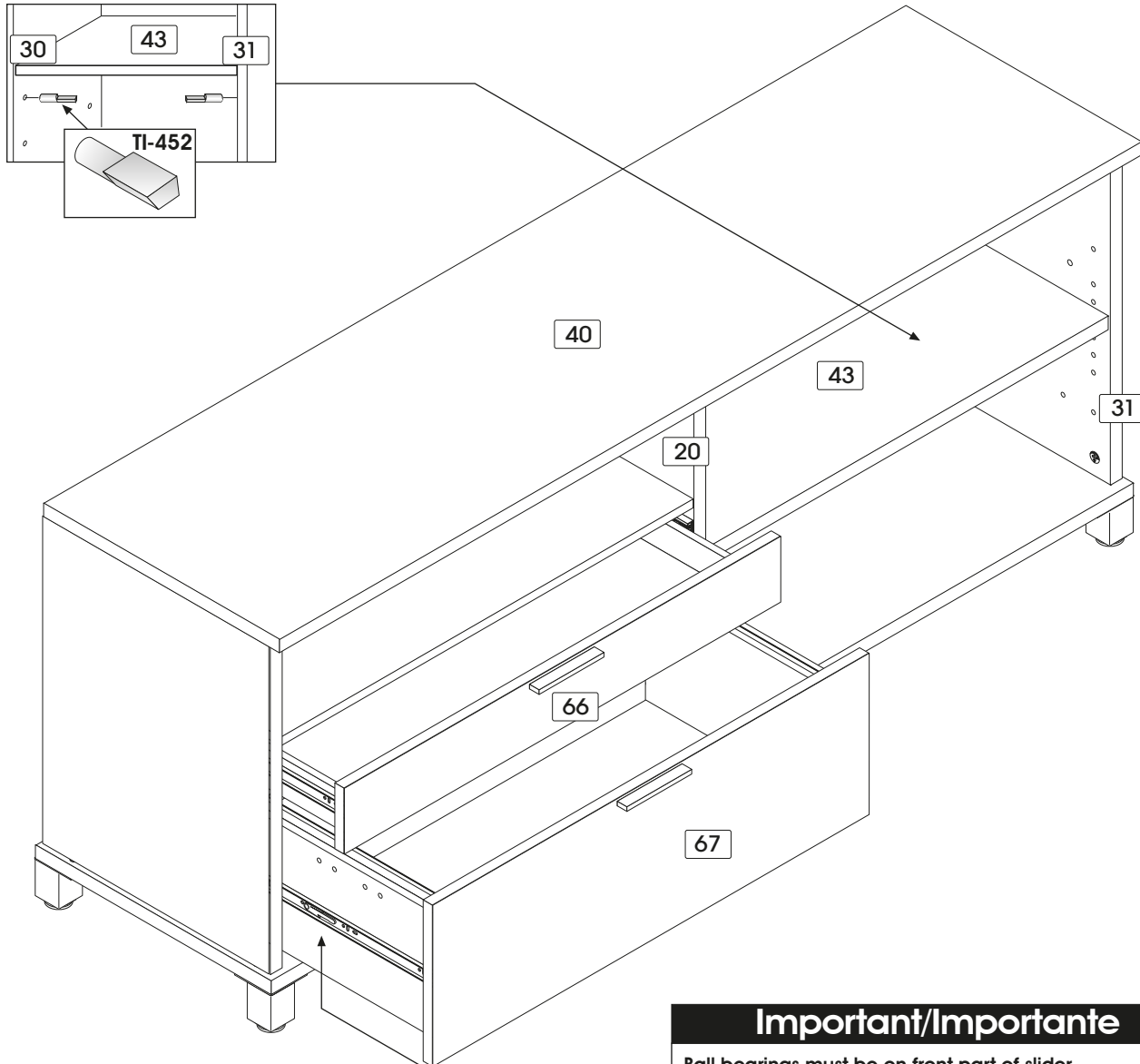

Important/Importante

Ball bearings must be on front part of slider when installing drawers.

Les roulements à billes doivent être sur la partie avant du coulisseau lors de l'installation des tiroirs.

Los cojinetes de bolas deben ubicarse sobre la parte delantera de guía en el momento de instalar los cajones.

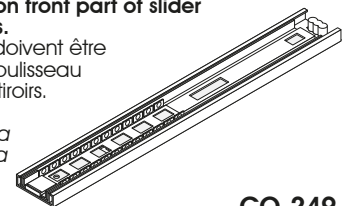

CO-249

To level your furniture, use leg levelers.

Pour niveler votre meuble utilisez les pattes ajustables.
Para nivelar su mueble utilice las patas ajustables.

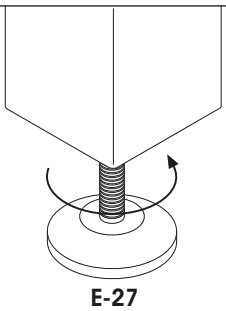

E-27

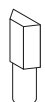

Code / Código

TI-452

Qty / Qté / Cant.

x 4

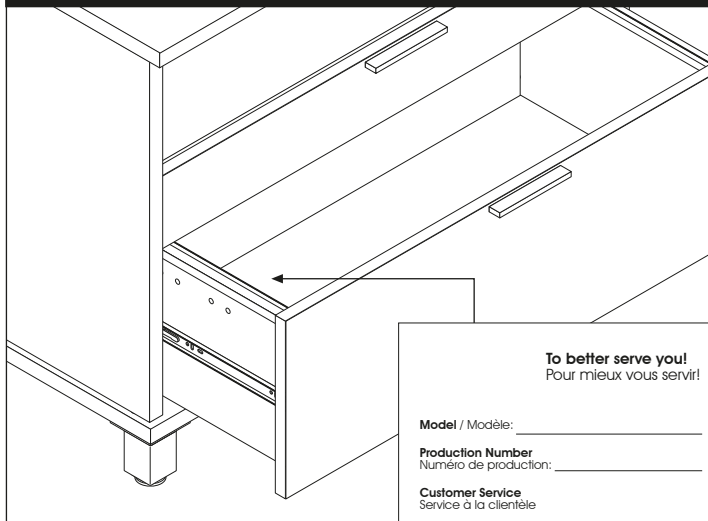
Important/Importante

For future reference and to better serve you, please apply the self-adhesive sticker in an accessible space such as inside a drawer.

Pour mieux vous servir en cas de besoin, veuillez apposer l'autocollant dans un endroit facilement accessible tel que l'intérieur d'un tiroir.

Para uno mejor servicio en caso de necesidad, poner la etiqueta en uno lugar de fácil acceso como por ejemplo al interior de un cajón.

When you have completed the assembly of your new furniture, install self-adhesive caps on unused holes.

Lorsque vous avez complété l'assemblage de votre meuble, installez les capuchons autocollants sur les trous non utilisés. Una vez que haya completado el ensamble del mueble, coloque los capuchones autoadhesivos en orificios no utilizados.

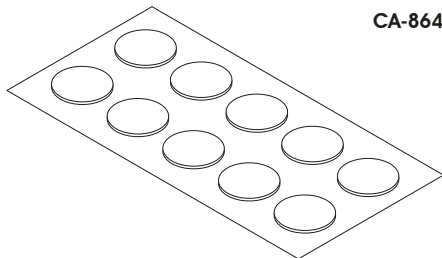
**PRODUCT CARE / ENTRETIEN DU PRODUIT / MANTENIMIENTO DEL PRODUCTO**

Avoid placing the furniture in the sunlight or near a source of heat. Use a soft dry cloth for dusting. To clean heavy dirt, use a cloth dipped in a solution of mild detergent and water. Avoid leaving wet objects on the surface or using commercial chemical cleaning products.

Évitez d'exposer le meuble au soleil ou près de toute source de chaleur. Pour le nettoyage, utilisez un chiffon doux et sec. Pour la grosse saleté, utilisez un chiffon humidifié avec un peu de détergent dilué dans l'eau. Évitez de laisser des objets mouillés sur la surface de votre meuble ou d'utiliser des nettoyeurs chimiques.

Evite exponer el mueble al sol o las fuentes de calor. Para limpiarlo, utilice un paño suave y seco. Para limpiar las manchas rebeldes, utilice un trapo húmedo con un poco de detergente diluido en agua. No deje objetos mojados encima del mueble ni utilice limpiadores que contengan productos químicos. química.

CONGRATULATIONS! YOU ARE NOW THE OWNER OF A QUALITY PRODUCT
 FÉLICITATIONS! VOUS AVEZ MAINTENANT EN VOTRE POSSESSION UN PRODUIT DE QUALITÉ
 FELICITACIONES! AHORA ES USTED DUEÑO DE UN PRODUCTO DE CALIDAD.

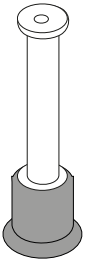

You are at a step of hardware installation and some H-36 are missing:
Before calling to order your missing bolts (H-36), please make sure you have not installed any bolts (H-36) in the wrong place. To remove a bolt (H-36) which is not in the correct place, please refer to your instruction manual.

Vous êtes à une étape d'installation de quincaillerie et il vous manque des H-36 :
Avant d'appeler pour commander des boulons (H-36), assurez-vous de ne pas avoir installé des boulons (H-36) au mauvais endroit. Pour enlever un boulon (H-36) mal situé, consultez le feuillet d'instructions.

Usted está en alguna etapa de la instalación de quincallas y le faltan las H-36 :
Antes de llamar para pedir los pernos (H-36), asegúrese de que no los haya instalado en el lugar equivocado.
Para retirar un perno (H-36) mal puesto, consulte el folleto de instrucciones.

How to separate and install your CO-249 and CO-684 slides:

The CO-249 & CO-684 slides consist of two sections which you must separate. To separate the slides, please refer to your instruction manual. The slides are installed on distinct parts which will be re-grouped only when the drawers are installed on the furniture.

Comment séparer et installer les coulisseaux CO-249 et CO-684 :
Les coulisseaux CO-249 et CO-684 sont constitués d'une partie que vous devez séparer en deux sections. Pour séparer le coulisseau, référez-vous au feuillet d'instructions. Les coulisseaux sont installés sur deux pièces distinctes et seront regroupés seulement lors de l'installation des tiroirs dans le meuble.

Cómo separar y instalar las guías correderas CO-249 y CO-684 :
Las guías correderas CO-249 y CO-684 están constituidas por una parte que usted debe separar en dos secciones. Para separar las guías correderas, consulte el folleto de instrucciones. Las guías correderas se instalan en dos piezas distintas y sólo serán reagrupadas una vez que se instalen los cajones en el mueble.

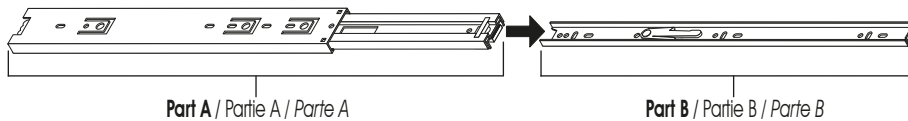

The doors on your furniture are crooked or the space between the doors is uneven:

It is very important to install the hinges and hinge plates on the correct parts while respecting the instruction manual.

Les portes de votre meuble sont croches ou l'espace qui les sépare est inégal :
Il est important d'installer les pentures et les plaques sur les bonnes pièces en respectant le feuillet d'instructions.

Las puertas de su mueble están chuecas o el espacio que las separa es desigual :
Es importante instalar las bisagras y las placas sobre las piezas adecuadas respetando el folleto de instrucciones.

The drawers on your furniture are crooked or the space between the drawers is uneven:

While referring to the section indicating the actual sizes of the screws in your instruction manual , please insure that you are using the correct size screws needed when installing your drawer slides and drawer fronts. They must be installed straight. While installing the drawer front, make sure that the correct side is facing up.

Les tiroirs de votre meuble sont croches ou l'espace qui les sépare est inégal :
En vous référant au tableau de vis grandeur réelle du feuillet d'instructions, assurez-vous que vous avez utilisé les bonnes vis lors de l'installation des coulisseaux ainsi que du devant de tiroir et qu'elles sont posées bien droites. Assurez-vous également que le devant du tiroir n'est pas assemblé à l'envers.

Los cajones de su mueble están chuecos o el espacio que los separa es desigual :
Consulte la tabla de tornillos en tamaño real del folleto de instrucciones y asegúrese de que haya utilizado los tornillos adecuados durante la instalación de las guías correderas así como también la parte delantera del cajón y que éstos estén puestos bien derechos.
Asegúrese también de que la parte delantera del cajón no esté ensamblada al revés.



For more information or to discover our new products

Pour toute information ou pour découvrir nos nouveaux produits

Para obtener más información o para obtener nuevos productos



FOR LONG TIME
POUR LONGTEMPS
POR MUCHO TIEMPO



OUR FURNITURE IS GARANTEED FOR 10 YEARS. NO MATTER THE PROBLEM, OUR CUSTOMER SERVICE IS THERE FOR YOU.

NOS MEUBLES SONT GARANTIS POUR 10 ANS. PEU IMPORTE LE PROBLÈME, N'HÉSITÉZ PAS À COMMUNIQUER AVEC NOTRE SERVICE À LA CLIENTÈLE.

NUESTROS MUEBLES TIENEN UNA GARANTIA DE 10 AÑOS. NO IMPORTA EL PROBLEMA, COMUNIQUE CON NUESTRO SERVICIO A CLIENTE.