

# Assembly Instructions

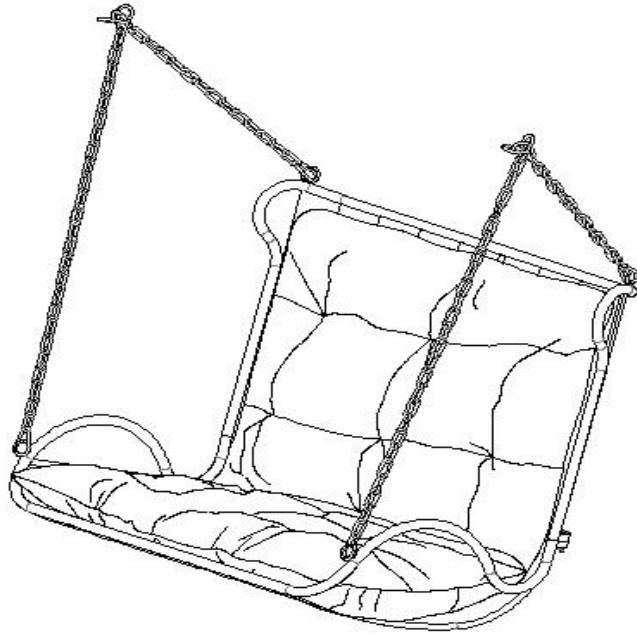

**Caution : You must read this before you proceed**

## Swing Basket Chair





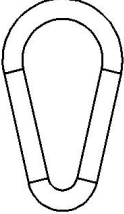
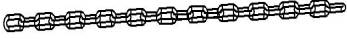



### Parts List

Label	Picture	Description	QTY
A		Basket Seat	1
B		Basket Back	1
C		Cushion	2

D		Carabiner	6
E		Chain-Longer	2
F		Chain-Shorter	2

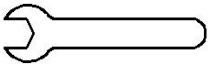
## Hardware

Label	Picture	Description	QTY
①		Bolt M6*50mm	7
②		Washer Ring	13
③		Nut	7
④		Allen Wrench	1
⑤		Wrench	1
⑥		Plastic Bolt Cap	7
⑦		Plastic Nut Cap	7

# Assembly Preparation

Before Beginning Assembly:

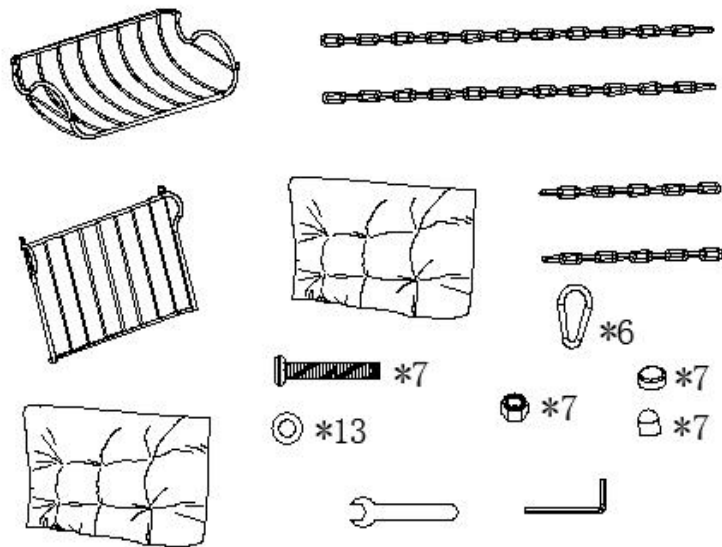

- Read instructions, cover to cover-



- Have 2 adults on hand for assembly-



- Do not assemble on flooring or carpet-



- Assemble on a clean non-marring surface (packing foam)-



- Save all packaging until finished-

# Assembly Steps

## Overview

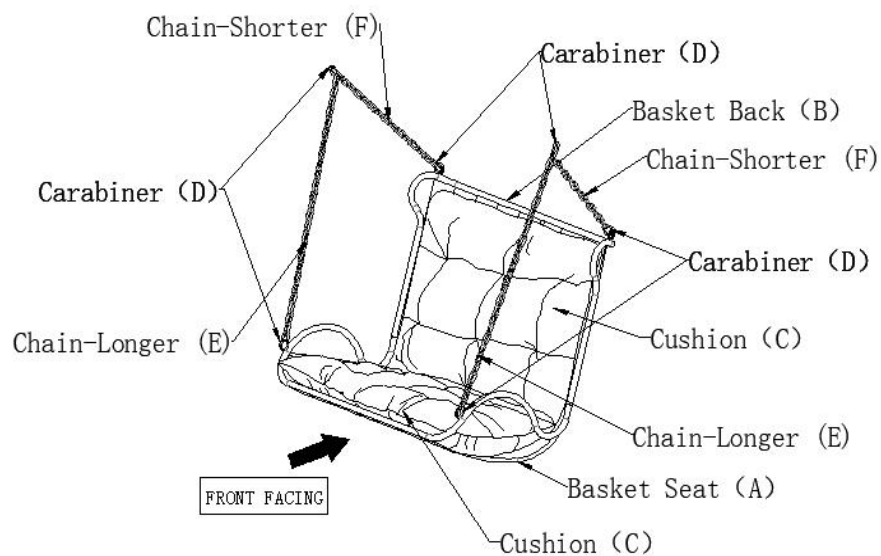

This Swing Basket Chair has multiple parts and may require up to some 30 minutes to assemble. To give you an overview of the Swing Basket Chair parts, the above picture is provided to help you put the various parts into perspective. Please read through the instructions below to familiarise yourself with the parts and steps before assembly.

## Step 1

# 1

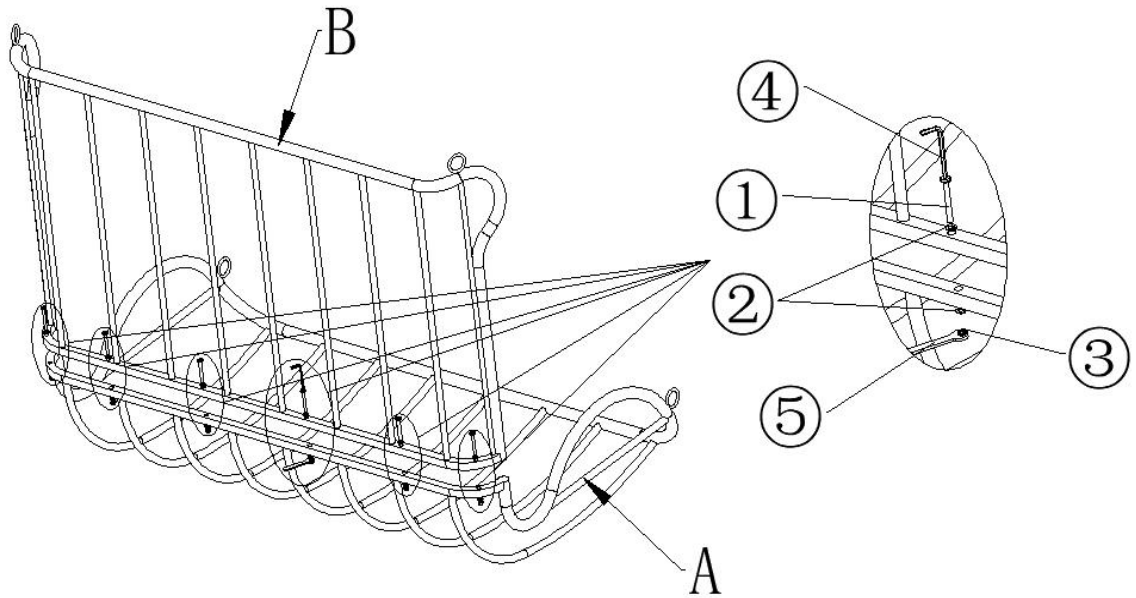

Open the carton and place all the parts onto a clean, soft surface.

Unpack all hardware packages.

Put the Basket Seat(A) against the Basket Back(B) and line up the two mounting positions of both.

Attach the Basket Seat(A) to the Basket Back(B) with the Allen Wrench(④) and Wrench (⑤) , using Flat Washers (②), Bolts (①) and Nuts (③), as shown in the picture above 1.

Do not fully tighten the Bolts at first,check for stability and then tighten all Bolts at all joints.

Note: DO NOT fully tighten a Bolt in one go and then move on to the next.

Rather in a sequential manner, gradually tighten each Bolt until all Bolts are evenly secured.

This methodology will ensure maximum evenness once all Bolts are fully tightened.

Caution:Two or three adults are required for assembly at this step.

## Step 2

# 2

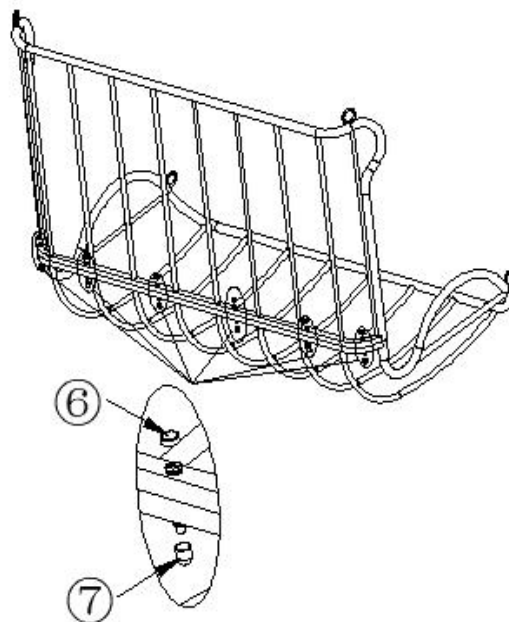

Cover all the Bolts and nuts with the Bolt Caps(⑥) and the Nut Caps(⑦) as shown in picture 2.

### Step 3

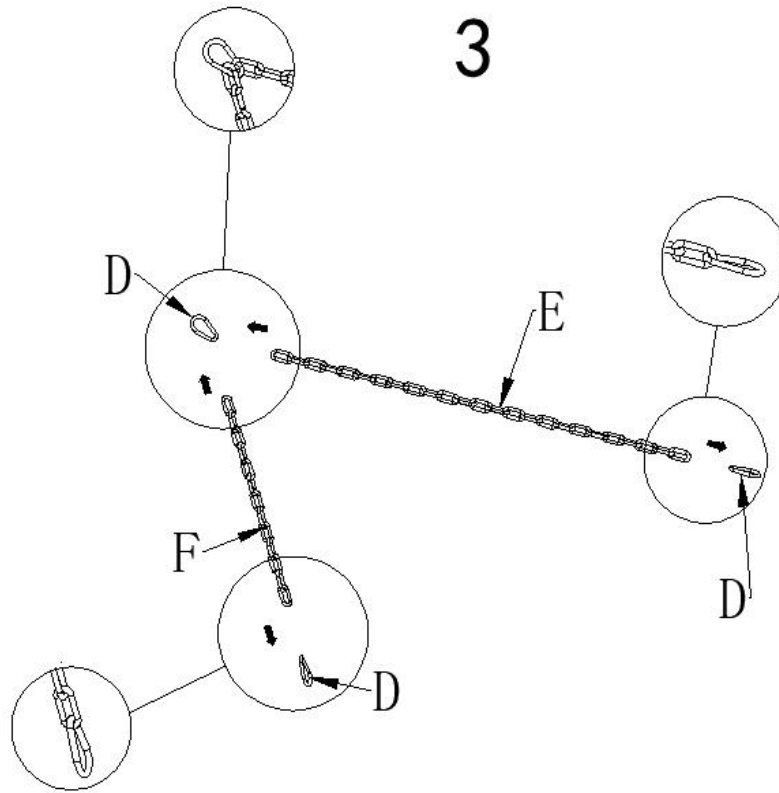

Attach the Carabiner(D) to the Chain-Longer(E) and Chain-Shorter(F) as shown in picture 3.

### Step 4

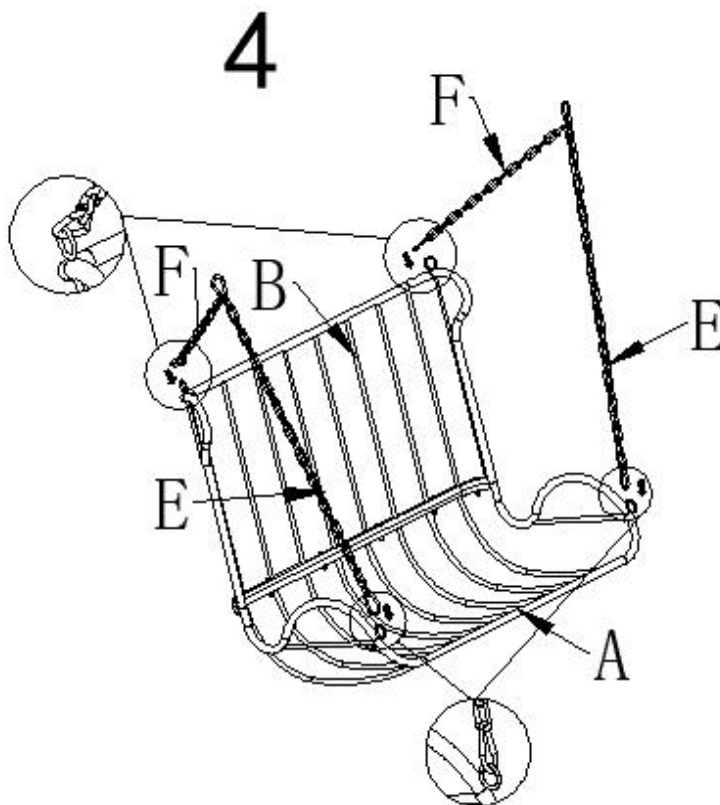





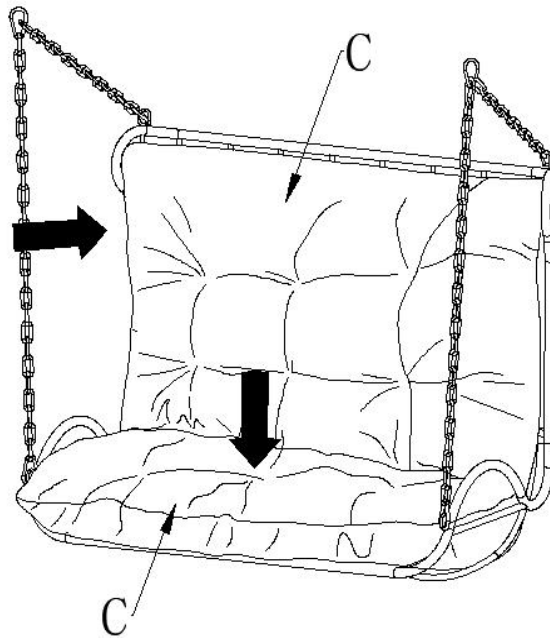





Attach the Carabiner(D) of the Chain-Longer(E) to the Circle of Basket Seat(A), and attach the Carabiner(D) of the Chain-Shorter(F) to the Circle of Basket Back(B) as shown in picture 4.  
Caution: The chain can be adjusted according to the customer's requirement.

## Step 5



Place the Cushion(C) in the Swing Basket Chair.  
Your Swing Basket Chair is ready for use.

### **Care & Maintenance**

- ⊘  • Prolonged exposure to rain may cause rusting which can stain floors.
- ⊘  • Do not put hot items directly on furniture surface.
- ⊘  • Do not clean furniture with harsh cleansers or polish.
- ✓  • To obtain the longest lifespan of your outdoor products, minimizing exposure to direct sunlight is recommended.
- ⊘  • Children should not climb or jump on the furniture.
- ⊘  • Do not write on furniture without a padded barrier to protect the surface.
- ✓  • To obtain the longest lifespan of your outdoor products, avoid extended and lengthy exposure to rain, snow, and direct sunshine. Whenever possible cover the product and /or place under patio or awnings.
- ⊘  • Not for commercial use. For residential use only.
- ⊘  • Stains may be removed with mild soap solution and damp cloth.
- ✓  • Keep away from sources of ignition.
- ✓  • Dust and pick-up spills using a clean, non-colored, lint-free cloth.