



# Window Air Conditioner User Manual

MODEL • MODÈLE • MODELO  
CWAM10W6C / CWAM12W6C



# CONTENTS

## SAFETY INFORMATION

Important Safety Instructions.....	4
Battery Information.....	5
Grounding Instructions.....	6
Power Cord Use.....	7
Safety Guidelines.....	8

## SET UP & USE

Window Requirements.....	9
Suggested Tools for Installation.....	9
Prepare the Window.....	10
Prepare Air Conditioner.....	11-14
Parts & Features.....	15-16
Operation Instructions.....	17-18

## CLEANING & CARE

Air Filter Cleaning.....	19
Winter Storage.....	19

## TROUBLE SHOOTING & WARRANTY

Before You Call For Service.....	20
Customer Service.....	20
Troubleshooting.....	21
Limited Warranty.....	22

1. READ these instructions carefully before installing and operating the appliance. Keep them for further reference.
2. Record in the space below the "SERIAL/MODEL NUMBER" found on the back or bottom of your appliance and retain this information for future reference.

SERIAL NUMBER:

MODEL NUMBER:

DATE OF PURCHASE:

Save and staple your sales receipt to your manual for warranty coverage.

# SAFETY INFORMATION

## DANGER

**DANGER** - Immediate hazards which **WILL** result in severe personal injury or death

## WARNING

**WARNING** - Hazards or unsafe practices which **COULD** result in severe personal injury or death

## CAUTION

**CAUTION** - Hazards or unsafe practices which **COULD** result in minor personal injury

## IMPORTANT SAFETY INSTRUCTIONS

### WARNING

When using electrical appliances, basic safety precautions should be followed, including the following

1. Air conditioner must be connected to proper electrical outlet with the correct electrical outlet with the correct electrical supply.
2. Proper grounding must be ensured to reduce the risk of shock and fire. **DO NOT CUT OR REMOVE THE GROUNDING PRONG.** If you do not have a three-prong electric receptacle outlet in the wall, have a certified electrician install the proper receptacle. The wall receptacle **MUST** be properly grounded.
3. Do not operate air conditioner if power cord is frayed or otherwise damaged. Avoid using it if there are any cracks or abrasion damage along the length, plug connector or if the unit malfunctions or is damaged in any manner. Contact an authorized service technician for examination, repairs or adjustments.
4. The cord must be with a new power supply cord obtained by the manufacturer and not repaired.
5. The appliance shall be stored in a room without continuously operating ignition sources (for example: open flames, an operating gas appliance or an operating electric heater).
6. **DO NOT USE AN ADAPTER OR AN EXTENSION CORD.**
7. Do not block airflow around the air conditioner.
8. Always unplug the air conditioner before servicing it or moving it.
9. Do not install or use the air conditioner in any area where the atmosphere contains combustible gases or where the atmosphere is oily or sulphurous. Avoid any chemical coming in contact with your air conditioner.
10. Do not place any object on the top of the unit.
11. Never operate the air conditioner without filters in place.
12. Do not use the air conditioner near a bathtub, shower or wash basin.
13. This appliance is not intended for use by persons (including children) with reduced physical sensory or mental capabilities or lack of experience & knowledge, unless they have been given supervision or instruction concerning use of the appliance by a person responsible for their safety.

## SAFETY INFORMATION

14. Children should be supervised to ensure that they do not play with the appliance.

# SAVE THESE INSTRUCTIONS

## HOUSEHOLD USE ONLY

### BATTERY INFORMATION

#### KEEP OUT OF REACH OF CHILDREN.

Swallowing may lead to serious injury or death. Severe burns can occur within 2 hours of ingestion. Immediately see a doctor and have the doctor phone (202) 625- 3333 collect. Keep in original package until ready to use. Dispose of used batteries immediately. Risk of injury due to fire, explosion or leakage. Do not disassemble, charge, crush or expose to fire or high temperatures.

#### LITHIUM COIN CELL SAFETY NOTICE:

Keep lithium coin batteries out of the reach of small children; coin cell batteries can be accidentally ingested. If ingested, these batteries may leak harmful contents causing chemical burns, perforation of soft tissue, and in severe cases may cause death. Lithium coin batteries must be removed immediately if swallowed. Seek medical attention immediately. If you or your doctor suspects that a battery has been ingested for assistance in the US call the NATIONAL BATTERY INGESTION HOTLINE any time at (202) 625-3333; in Canada call 416-813-5900.

- In order to prevent unnecessary battery drain, do not store anything on the fan.
- Do not dispose of batteries in fire. Batteries may explode or leak.
- Remove the battery if the remote is not used for a long period of time.

# SAVE THESE INSTRUCTIONS

## HOUSEHOLD USE ONLY

# SAFETY INFORMATION

## GROUNDING INSTRUCTIONS

### ELECTRICAL REQUIREMENTS

The electrical requirements are a 115 volt 60 Hz, AC only, 15 amp. It is recommended that a separate circuit serving only the product be provided. The product is equipped with a 3-wire cord having a 3-prong grounding plug. It must be plugged into a wall receptacle that is properly installed and grounded.

This appliance must be grounded. In the event of an electrical short circuit, grounding reduces risk of electric shock by providing an escape wire for the electric current. The cord provided with this appliance is equipped with a grounding wire and a grounding plug. The plug must be plugged into an outlet that is properly installed and grounded.

Avoid the use of three prong adapters or cutting off the third grounding prong in order to accommodate a two prong outlet. This is a dangerous practice since it provides no effective grounding for the air conditioner and may result in shock hazard.

Consult a qualified electrician or serviceman if:

- 1) The grounding instructions are not completely understood.
- 2) You are unsure that the appliance is properly grounded.
- 3) You have any questions about the grounding or electrical instructions.

### POWER SUPPLY CORD

## WARNING

Improper use of the grounding plug can result in a risk of electric shock.

1. Avoid the use of an extension cord because of potential safety hazards under certain conditions. Have a qualified electrician or serviceman to install an outlet near the appliance.

**NOTE:** Neither W Appliance nor the dealer can accept any liability for damage to the product or personal injury resulting from failure to observe the electrical connection procedures.

# SAFETY INFORMATION

## POWER CORD USE

The power supply cord contains a current device that senses damage to the power cord. To test your supply cord follow these steps:

1. Plug in the Air Conditioner.
2. The power supply cord head has two buttons, a TEST button and a RESET button. Press the TEST button and notice a click as the RESET button pops out.
3. Press the RESET button. Once again notice a click as the button engages.
4. The power supply cord will now supply electricity to the unit.

### NOTE:

- Do not use this device to turn the unit on or off.
- Always make sure the reset button is pushed in for correct operation
- The power supply cord must be replaced if it fails to reset when either the test button is pushed, or it cannot be reset.
- If power supply cord is damaged, it cannot be repaired.
- It must be replaced by one obtained from the product manufacturer.

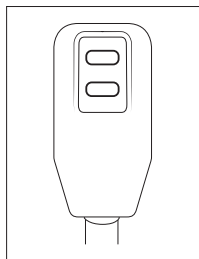

## OPERATING CONDITION

The air conditioner must be operated within the temperature range indicated below:

- NOTE:** · Unit performance may be affected when in use outside of these operating temperatures.

# SAFETY INFORMATION

## SAFETY GUIDELINES

To prevent injury to the user or other people and property damage, the following instructions must be followed. Incorrect operation due to ignoring of instructions may cause harm or damage.

ALWAYS DO THIS	NEVER DO THIS	ENERGY SAVE
<ul style="list-style-type: none"> <li>• Your air conditioner should be used in such a way that it is protected from moisture. e.g. condensation, splashed water, etc. Do not place or store your air conditioner where it can fall or be pulled into water or any other liquid. Unplug immediately.</li> <li>• Always transport your air conditioner in a vertical position and stand on a stable, level surface during use.</li> <li>• Turn off the product when not in use.</li> <li>• Always contact a qualified person to carry out repairs. If the supply cord is damaged it must be repaired by a qualified technician.</li> <li>• Keep an air path of at least 12 inches. all around the unit from walls, furniture and curtains.</li> <li>• If the air conditioner is knocked over during use, turn off the unit and unplug from the power supply immediately.</li> </ul>	<ul style="list-style-type: none"> <li>• Do not operate your air conditioner in a wet room such as a bathroom or laundry room.</li> <li>• Do not touch the unit with wet or damp hands or when barefoot.</li> <li>• Do not press the buttons on the control panel with anything other than your fingers.</li> <li>• Do not remove any fixed covers. Never use this appliance if it is not working properly, or if it has been dropped or damaged.</li> <li>• Never use the plug to start and stop the unit.</li> <li>• Always use the switch on the control panel to start or shut off the unit.</li> <li>• Do not cover or obstruct the inlet or outlet grilles.</li> <li>• Do not use hazardous chemicals to clean or come into contact with the unit. Do not use the unit in the presence of inflammable substances or vapour such as alcohol, insecticides, petrol, etc.</li> <li>• Do not allow children to operate the unit unsupervised.</li> <li>• Do not use this product for functions other than those described in this instruction manual.</li> </ul>	<ul style="list-style-type: none"> <li>• Use the unit in the recommended room size.</li> <li>• Locate the unit where furniture cannot obstruct the air flow.</li> <li>• Keep blinds/curtains drawn.</li> <li>• Keep the filters clean.</li> <li>• Keep doors and windows closed to keep cool air in and warm air out.</li> </ul>



# SET UP & USE

**NOTE:** All the illustrations in this manual are for explanation purpose only. The air conditioner you have may be slightly different.

## WINDOW REQUIREMENTS:

Your air conditioner is designed to install in standard double hung windows with opening widths of 23 to 36 inches (584mm to 914mm).



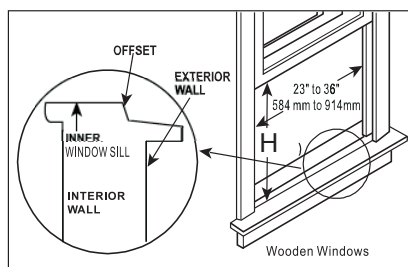
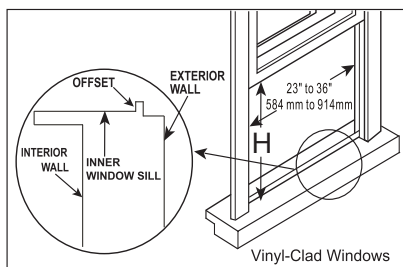

MODEL: 10,000-12,000 BTU - HEIGHT: 15-1/2 (394mm)



## CAUTION

- Do not, under any circumstances, cut or remove the third (ground) prong from the power cord.
- Do not change the plug on the power cord of the air conditioner.
- Aluminum house wiring may present special problems- consult a qualified electrician.
- When handling unit, be careful to avoid cuts from sharp metal edges and aluminum fins on front and rear coils.

## SUGGESTED TOOLS FOR INSTALLATION

- Screwdriver (Phillip & Flat) 
- Level 
- Pencil 
- Ruler or tape measure 
- Scissors or knife 

**NOTE:** Save Carton and Installation Instructions for future reference. The carton is the best way to store unit during winter or when not in use.

# SET UP & USE

## PREPARE THE WINDOW

Lower sash must open sufficiently to allow a clear vertical opening of 13 inches (330mm). Side louvers and the rear of the AC must have clear air space to allow enough airflow through the condenser, for heat removal. The rear of the unit must be outdoors, not inside a building or garage.

### MOUNTING HARDWARE

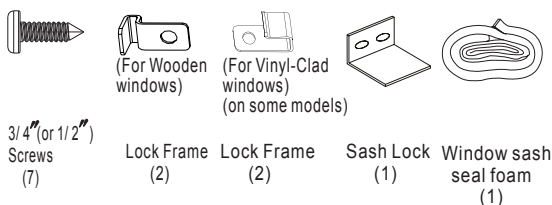

## PREPARE AIR CONDITIONER

A: Remove the air conditioner from the carton and place on a flat surface.

B: Remove top rail and R1 hardware (R1 hardware and Weather stripping only for Energy star models) from the packaging material as shown in Fig. A.

### TOP RAIL HARDWARE

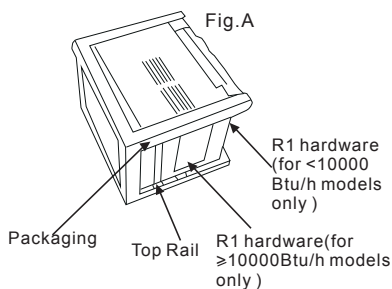
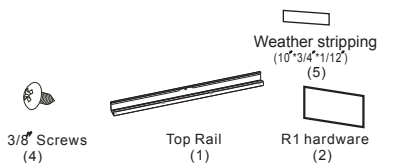

This device complies with part 15 of the FCC rules. Operation is subject to the following two conditions: 1) This device may not cause harmful interference, and 2) This device must accept any interference received, including interference that may cause undesired operation. This equipment has been tested and found to comply with the limits for a Class B digital device, pursuant to Part 15 of the FCC rules. These limits are designed to provide reasonable protection against harmful interference in a residential installation. This equipment generates, uses and can radiate radio frequency energy and, if not installed and used in accordance with the instructions, may cause harmful interference to radio communications. However, there is no guarantee that the interference will not occur in a particular installation. If this equipment does cause harmful interference to radio or television reception, which can be determined by turning the equipment off and on, the user is encouraged to try to correct the interference by one or more of the following measures: a) Reorient or relocate the receiving antenna. b) Increase the separation between the equipment and the receiver. c) Connect the equipment into an outlet different from that which the receiver is connected. d) Consult the dealer or an experienced radio/TV technician for help.

# SET UP & USE

C: Align the hole in the top rail with those in the top of the unit as shown in Fig. B

Fig. B

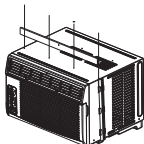

D: Secure the top rail to the unit with the 3/8 Screws as shown in Fig. C.

Fig. C

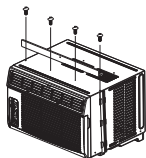

**NOTE:** For safety reasons, all four (4) screws MUST be securely fastened.

**NOTE:** The top rail hardware and the Fig. A, Fig. B and Fig. C are not applicable to the units more than 10000 Btu/h. Before installing unit, the top rail must be assembled on the unit (For <10,000 Btu/h models only).

## INSTALL THE ACCORDION PANELS

**NOTE:** Top rail and Sliding Panels at each side are offset to provide the proper pitch to the rear of (5/16).

This is necessary for proper condensed water utilization and drainage. If you are not using the Side Panels for any reason, this pitch to the rear must be maintained.

A. Place unit on floor, a bench or a table. Hold the Accordion Panel in one hand and gently pull back the center to free the open end. See Fig.1

Fig. 1

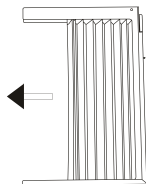

B. Slide the free end "I" section of the panel directly into the cabinet as shown in Fig. 2. Slide the panel down. Be sure to leave enough space to slip the top and bottom of the frame into the rails on the cabinet.

Fig. 2

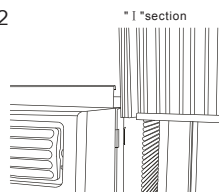

C. Once the panel has been installed on the side of the cabinet, make sure it sits securely inside the frame channel by making slight adjustments. Slide the top and bottom ends of the frame into the top and bottom rails of the cabinet. Fig. 3.

Fig. 3

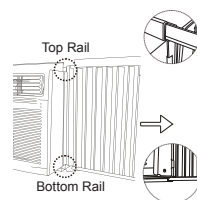

D. Slide the panel all the way in and repeat on the other side.

Fig. 4

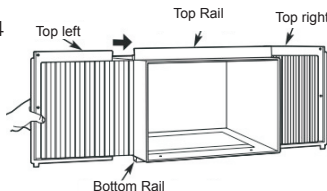

**NOTE:** If storm window blocks AC, see Fig. 11.

# SET UP & USE

## SECURE THE ACCORDION PANELS

- A. Keep a firm grip on the air conditioner, carefully place the unit into the window opening so the bottom of the air conditioner frame is against the window sill (Fig. 5A and Fig. 5B). Carefully close the window behind the top rail of the unit.

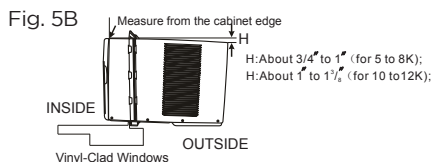
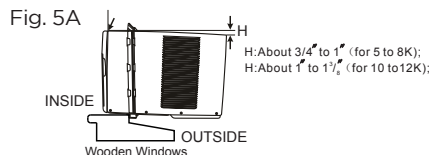

- NOTE:** Check that air conditioner is tilted back about H (Fig. 5A and Fig. 5B) (tilted about 30 to 40 downward to the outside). After proper installation, condensate should not drain from the overflow drain hole during normal use, correct the slope otherwise.

- B. Extend the side panels out against the window frame (Fig. 6).

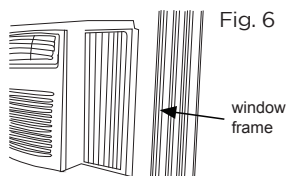

## INSTALL SUPPORT BRACKET

- A. Place the frame lock between the frame extensions and the window sill as shown (Fig. 7A for Wooden windows), (Fig. 7B for Vinyl-Clad windows).

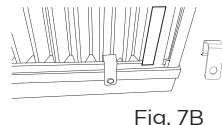
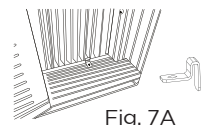

## DRIVE LOCKING SCREWS FOR WOODEN WINDOWS:

Drive  $1/2$  (12.7 mm) locking screws through the frame lock and into the sill (Fig. 8A).

**NOTE:** To prevent window sill from splitting, drill  $1/8$  (3mm) pilot holes before driving screws. Drive  $1/2$  (12.7mm) locking screws through frame holes into window sash (Fig. 8B).

## FOR VINYL-CLAD WINDOWS:

Drive  $1/2$  (12.7 mm) locking screws through the frame lock and into the window sash (Fig.8B).

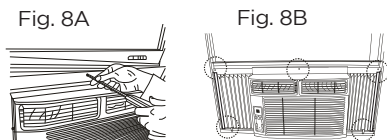

**NOTE:** Before driving the screws, use a drill to drill 5 holes through the holes in the frame lock and frame extensions into the windows sash as shown (Fig. 8B).

- C. To secure lower sash in place, attach right angle sash lock with  $3/4''$  (19mm) or  $1/2''$  (12.7mm) screw as shown (Fig.9).

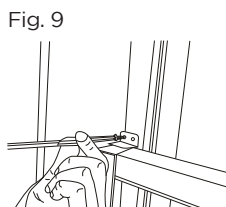

- D. Cut Window sash seal foam and insert it in the space between the upper and lower sashes (Fig.10).

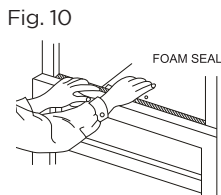

# SET UP & USE

## INSTALL R1 HARDWARE

In order to minimize air leaks and ensure optimal insulation, it is necessary to install the included R1 hardware to the side curtain. Follow the instructions below.

Step 1. After the unit is installed to the window, measure the inner width of the side curtain as shown (Fig.11).

Step 2. Remark a line on the provide R1 insulation panel according to a length  $1/8$  (3mm) less than the measured width in step 1, then cut the R1 insulation panel along the line (Fig.12).

Fig. 11

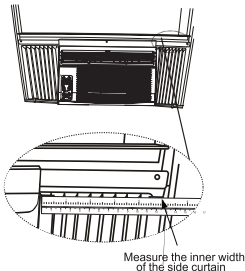
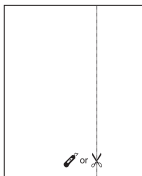
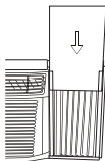

Fig. 12



Step 3. Slide the R1 insulation panel into the side curtain, the side with pattern should facing the indoor side. (Fig.13).

Fig. 13



Step 4. Repeat on the other side.

## INSTALL WEATHER STRIPPING

(only be applicable to Energy star models)

In order to minimize air leaks between the room air conditioner and the window opening, trim the weather stripping with a proper length, peel off the protective backing and plug any gaps if needed (Fig.14).

Fig. 14

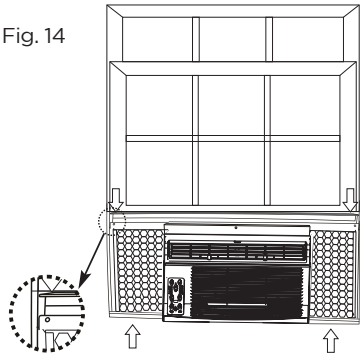

## IF AC IS BLOCKED BY STORM WINDOW

Add wood as shown in Fig.15 or remove storm window before air conditioner is installed. If Storm Window Frame must remain, be sure the drain holes or slots are not caulked or painted shut. Accumulated Rain Water or Condensation must be allowed to drain out.

## REMOVING AC FROM WINDOW

Turn AC off and disconnect power cord. Remove sash seal from between windows and unscrew safety sash lock. Remove screws installed through frame and frame lock. Remove the R1 Panel and close (slide) side panels into frame. Keeping a firm grip on air conditioner, raise sash and carefully remove. Be carefully not to spill any remaining water while lifting unit from window. Store parts WITH air conditioner.

Fig. 15

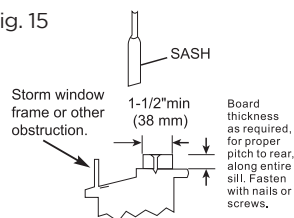

# SET UP & USE

## AIR CONDITIONER FEATURES

**WARNING:** To reduce the risk of fire, electric shock, or injury to persons, read the IMPORTANT SAFETY INSTRUCTIONS before operating this appliance.

**CAUTION:** Please always wait 3 minutes when turning unit off then on again, and when changing from cool to fan and back to cool. This prevents compressor from overheating & possible circuit breaker tripping.

**To begin operating the air conditioner, follow these steps:**

1. Set the thermostat to the highest number (coldest or cooler setting).
2. Set the selector control to the highest COOL setting.
3. Adjust the louver for comfortable air flow (see Air Directional Louvers).
4. Once the room has cooled, adjust the thermostat to the setting you find most comfortable.
5. Make sure that the air flow inside and outside are not obstructed by anything.

## AIR DIRECTIONAL LOUVERS

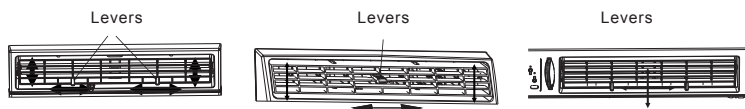

The louvers will allow you to direct the air flow Up or Down (on some models) and Left or Right throughout the room as needed. Pivot horizontal louvers until the desired Up/Down direction is obtained. Move the Lever(s) from side to side until the desired Left/Right direction is obtained.

## FRESH AIR VENT CONTROL

Fig. A (VENT CLOSED)

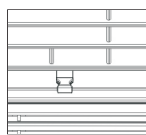

Fig. C (VENT & EXHAUST OPEN))

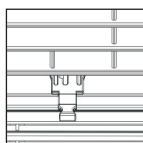
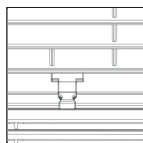

Fig. B (VENT OPEN)



The Fresh Air Vent allows the air conditioner to:

1. Recirculate inside air - Vent Closed (See Fig. A)
2. Draw fresh air into the room- Vent Open (see Fig. B)
3. Exchange air from the room and draws fresh air into the room - Vent and Exhaust Open (see Fig. C)

# SET UP & USE

## PARTS & FEATURES

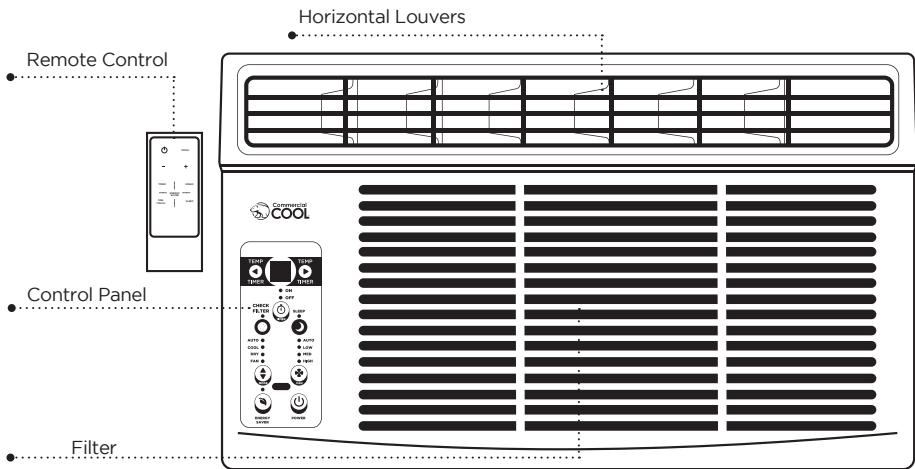

Control Panel

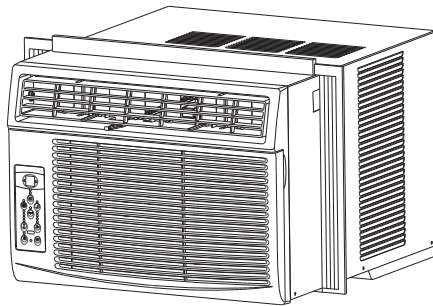
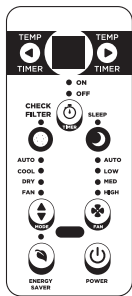

## BATTERY INSTRUCTIONS

**Note:** Battery Not Included

Step 1: Insert a coin vertically in the groove on the battery cover, clockwise rotation of 45 degrees, make sure that the groove is aligned with the "unlock" sign as shown below and remove the battery cover.

Step 2: Install battery inside the remote controller, the positive (+) side up.

Step 3: Install the battery cover, make sure the battery cover groove is aligned with the "unlock" sign. Insert a coin vertically in the groove and press it gently, then counter clockwise rotation of 45 degrees, make sure the groove is aligned with the "lock" sign as shown below.

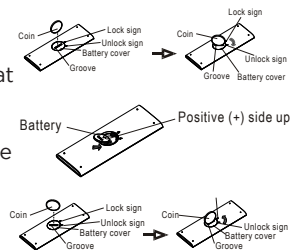

### WARNING:

1. Battery must be disposed of properly. Do not short circuit or dispose of in the fire.
2. Keep batteries out of the reach of children.
3. Caution for ingestion.
4. Non-rechargeable batteries are not to be recharged.
5. Exhausted batteries are to be removed from the product.

# SET UP & USE

## REMOTE CONTROL

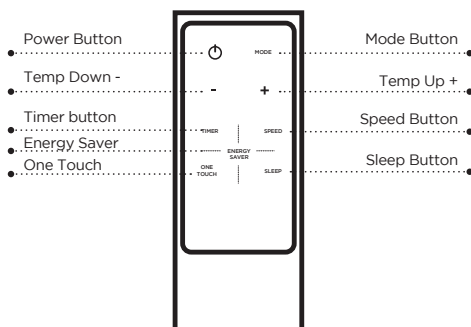

### POWER BUTTON

Operation starts when this button is pressed and stops when the button is pressed again.

**NOTE:** If the unit has ENERGY SAVER function, it will initiate automatically the Energy Saver function under Cool, Dry, and Auto (only Auto-Cooling and Auto-Fan) modes.

### MODE BUTTON

Press this button to select the desired operation mode.

### TEMP DOWN BUTTON

Push this button to decrease the indoor temperature setting.

### TEMP UP BUTTON

Push this button to increase the temperature setting.

### TIMER BUTTON

Push this button to activate the auto Start or auto Stop program.

### LOCATION OF THE REMOTE CONTROLLER:

Use the remote controller within a distance of 16 feet from the appliance, pointing it towards the receiver. Reception is confirmed by a beep.

### CAUTION:

- The air conditioner will not operate if curtains, doors or other materials block the signals from the remote controller to the unit.
- Prevent any liquid from falling into the remote controller. Do not expose the remote controller to direct sunlight or heat.
- If the infrared signal receiver on the indoor unit is exposed to direct sunlight, the air conditioner may not function properly. Use curtains to prevent the sunlight from falling on the receiver.
- If other electrical appliances react to the remote controller, either move these appliances or consult your local dealer.

### SPEED BUTTON

Used to select the desired fan speed.

### ONE TOUCH BUTTON

Push this button, the system will automatically shift to COOL operation with auto fan speed, the setting temperature is 26OC/80OF. And the timer setting program will be cancelled.(on some models)

### SLEEP BUTTON

Press this button to activate the Sleep mode. This function is available on COOL, HEAT or AUTO mode only and maintain the most comfortable temperature for you and save enrgy. For the detail, see sleep operation in USER, S MANUAL

### ENERGY SAVER BUTTON

Press this button to activate the Energysaving mode. Press it again to stop the funtion.(on some models)



# SET UP & USE

## OPERATING INSTRUCTIONS

The unit can be controlled by the unit control alone or with the remote.

**NOTE:** The outline of the operation panel is based on typical model, the function is the same with your air conditioner while some difference may exist in appearance.

## TO TURN UNIT ON OR OFF:

Press ON/OFF button to turn unit on or off.

**NOTE:** The unit will initiate automatically the Energy Saver function under Cool, Dry and Auto modes.

## TO CHANGE TEMPERATURE SETTING:

Press UP/DOWN button to change temperature setting.

**NOTE:** Press or hold either UP or DOWN button until the desired temperature is shown on the display.

This temperature will be automatically maintained anywhere between 62°F (17°C) and 86°F (30°C). If you want the display to read the actual room temperature, see To Operate on Fan Only section.

## SLEEP FEATURE:

Press Sleep button to initiate the sleep mode. In this mode the selected temperature will increase by 2°F/1 (or 2)°C 30 minutes after the mode is selected. The temperature will then increase (cooling) by another 2°F/1 (or 2)°C after an additional 30 minutes. This new temperature will be maintained for 6 or 7 hours before it returns to the originally selected temperature. This ends the Sleep mode and the unit will continue to operate as originally programmed. The Sleep mode program can be cancelled at any time during operation by pressing the Sleep button again.

## TO ADJUST FAN SPEEDS:

Press Fan button to select the Fan Speed in four steps-Auto, Low, Med or High. Each time the button is pressed, the fan speed mode is shifted. For some models, the fan speed cannot be adjusted.

## CHECK FILTER FEATURE:

Press Check filter button to initiate this feature. This feature is a reminder to clean the Air Filter for more efficient operation. The LED(light) will illuminate after 250 hours of operation. To reset after leaning the filter, press the Check Filter button and the light will go off.

## ENERGY SAVER FEATURE:

Press Energy saver button to initiate this function. This function is available on COOL, DRY, AUTO (only AUTO-COOLING and AUTO-FAN) modes. The fan will continue to run for 3 minutes after the compressor shuts off. The fan then cycles on for 2 minutes at 10 minute intervals until the room temperature is above the set temperature, at which time the compressor turns back on and Cooling Starts.

## TO SELECT THE OPERATING MODE:

To choose operating mode, press Mode button. Each time you press the button, a mode is selected in a sequence that goes from Auto, Cool, Dry and Fan. The indicator light beside will be illuminated and remained on once the mode is selected.

The unit will initiate automatically the Energy Saver function under Cool, Dry, Auto (only Auto-Cooling and Auto-Fan) modes.

## TO OPERATE ON COOL MODE:

Choose Cool Mode to set the cooling function. Use the Up and Down buttons to choose the desired temperature. When Cool Mode is selected, the fan speed can be adjusted by pressing the fan button.

# SET UP & USE

## TO OPERATE ON AUTO

### FEATURE:

- When you set the air conditioner in AUTO mode, it will automatically select cooling, heating (cooling only models without), or fan only operation depending on what temperature you have selected and the room temperature.
- The air conditioner will control room temperature automatically round the temperature point set by you.
- In this mode, the fan speed cannot be adjusted, it starts automatically at a speed according to the room temperature.

## TO OPERATE ON FAN ONLY:

- Use this function only when cooling is not desired, such as for room air circulation or to exhaust stale air (on some models). (Remember to open the vent during this function, but keep it closed during cooling for maximum cooling efficiency.) You can choose any fan speed you prefer.
- During this function, the display will show the actual room temperature, not the set temperature as in the cooling mode.
- In Fan only mode, the temperature is not adjusted.

## TO OPERATE ON DRY MODE:

In this mode, the air conditioner will generally operate in the form of a dehumidifier. Since the conditioned space is a closed or sealed area; some degree of cooling will continue. On Dry mode, the fan speed is controlled at Low automatically.

## TIMER: AUTO START/STOP FEATURE:

- Press Timer button, the TIMER ON or TIMER OFF indicator light illuminates. It indicates the Auto Start or Auto Stop program is initiated. For some units, keep pressing the Timer button will cancel the timer settings.
- Press or hold the UP or DOWN button to change the Auto time by 0.5-hour increments, up to 10 hours, then at 1 hour increments up to 24 hours. The control will count down the time

remaining until start.

- The selected time will register in 5 seconds, and the system will automatically revert back to display the previous temperature setting or room temperature when the unit is on (when the unit is off, there is no display.)
- Turning the unit ON or OFF at any time or adjusting the timer setting to 0.0 will cancel the Auto Start/Stop timed program.

**DISPLAYS:** Shows the set temperature in “OC” or “OF” and the Auto-timer settings. While on Fan only mode, it shows the room temperature. If the room temperature is too high or low, it will display “HI” or “LO”

### ERROR CODES:

AS - Room temperature sensor error

ES - Evaporator temperature sensor error

or •

**NOTE:** “•” is displayed as shown in the above picture.

HS -Electric heating sensor error(on some models);

CS -Condenser temperature sensor error(on some models);

OS -Outside temperature sensor error(on some models);

E7 -Unit malfunction(on some models).

**NOTE:** When error occurs,unplug the unit and plug it back in.If error repeats, call for service.

**NOTE:** If the unit breaks off unexpectedly due to the power cut, it will restart with the previous function setting automatically when the power resumes.

## ADDITIONAL THINGS YOU SHOULD KNOW

Now that you have mastered the operating procedure, here are more features in your control that you should become familiar with.

- The Cool circuit has an automatic 3 minutes time delayed start if the unit is turned off and on quickly. This prevents overheating of the compressor and possible circuit breaker tripping.The fan will continue to run during this time.
- The control is capable of displaying temperature in degrees Fahrenheit or degrees Celsius. To convert from one to the other, press and hold the Up and Down buttons at the same time for 3 seconds.

# CLEANING & CARE

## DANGER

1. Be sure to unplug the unit before cleaning or servicing.
2. Do not use gasoline, thinner or other chemicals to clean the unit.
3. Do not wash the unit directly under a tap or using a hose. It may cause electrical danger.
4. If the power cord is damaged, it should be repaired by an authorized technician.

## AIR FILTER CLEANING

**CAUTION:** Clean your air conditioner occasionally to keep it looking new. Be sure to unplug the unit before cleaning to prevent shock or fire hazards.

The air filter should be checked at least once a month to see if cleaning is necessary. Trapped particles in the filter can build up and cause an accumulation of frost on the cooling coils

- Push the vent handle to the Vent Closed position (where applicable). Open the front panel.
- Take the filter by the center and pull up and out.
- Wash the filter using liquid dishwashing detergent and warm water. Rinse filter thoroughly. Gently shake excess water from the filter. Be sure the filter is thoroughly dry before replacing. Instead of washing, you may vacuum the filter clean.

**Note:** Never use hot water over 40 C(104 F) to clean the air filter. Never attempt to operate the unit without the air filter.

## CABINET CLEANING

- Be sure to unplug the air conditioner to prevent shock or fire hazard. The cabinet and front may be dusted with an oil-free cloth or washed with a cloth dampened in a solution of warm water and mild liquid dishwashing detergent. Rinse thoroughly and wipe dry.
- Never use harsh cleaners, wax or polish on the cabinet front.
- Be sure to wring excess water from the cloth before wiping around the controls. Excess water in or around the controls may cause damage to the air conditioner.
- Plug in air conditioner.

## WINTER STORAGE

If you plan to store the air conditioner during the winter, remove it carefully from the window according to the installation instructions. Cover it with plastic or return it to the original carton.

# TROUBLESHOOTING & WARRANTY

## BEFORE YOU CALL FOR SERVICE

IF THE AIR CONDITIONER FAILS TO OPERATE:

- A) Check to make sure that the air conditioner is plugged in securely. If it is not, remove the plug from the outlet, wait 10 seconds and plug it in again securely.
- B) Check for a blown circuit fuse or a tripped main circuit breaker. If these seem to be operating properly, test the outlet with another appliance.

IF NONE OF THE ABOVE SOLVES THE PROBLEM, CONTACT A QUALIFIED TECHNICIAN. DO NOT TRY TO ADJUST OR REPAIR THE AIR CONDITIONER YOURSELF. Any person who is involved with working on or breaking into a refrigerant circuit should hold a current valid certificate from an industry-accredited assessment authority, which authorizes their competence to handle refrigerants safely in accordance with an industry recognized assessment specification.



### WARNING

Do not use means to accelerate the defrosting process or to clean other than those recommended by the manufacturer.

Servicing shall only be performed as recommended by the equipment manufacturer. Maintenance and repair requiring the assistance of other skilled personnel shall be carried out under the supervision of the person competent in the use of the flammable refrigerants.

## CUSTOMER SERVICE

# IMPORTANT

### DO NOT RETURN THIS PRODUCT TO THE STORE

If you have a problem with this product, please contact the W Appliance Co. Customer Satisfaction Center at 1-855-855-0294. DATED PROOF OF PURCHASE, MODEL # AND SERIAL # REQUIRED FOR WARRANTY SERVICE

## TROUBLESHOOTING

Troubleshoot your problem by using the chart below. If the air conditioner still does not work properly, contact W Appliance Co. customer service center or the nearest authorized service center. Customers must never troubleshoot internal components.

# TROUBLESHOOTING & WARRANTY

TROUBLE	ANALYSIS
Air conditioner does not start	<ul style="list-style-type: none"> <li>• Wall plug disconnected. Push plug firmly into wall outlet.</li> <li>• House fuse blown or circuit breaker tripped. Replace fuse with time delay type or reset circuit breaker.</li> <li>• Plug Current Device Tripped. Press the RESET button.</li> <li>• Power is OFF. Turn power ON.</li> </ul>
Air from unit does not feel cold enough	<ul style="list-style-type: none"> <li>• Room temperature below 62°F (17°C). Cooling may not occur until room temperature rises above 62°F (17°C).</li> <li>• Temperature sensing behind air filter element touching cold coil. Keep it from the cold coil.</li> <li>• Set to a Lower temperature.</li> <li>• Compressor stopped when changing modes. Wait for 3 minutes after set to the COOL mode.</li> </ul>
Air conditioner cooling, but room is too warm- ice forming on cooling coil behind decorative front.	<ul style="list-style-type: none"> <li>• Outdoor temperature below 64 F(18 C). To defrost the coil, set FAN ONLY mode.</li> <li>• Air filter may be dirty. Clean filter. Refer to Care and Cleaning section. To defrost, set to FAN ONLY mode.</li> <li>• Thermostat set too cold for night-time cooling. To defrost the coil, set to FAN ONLY mode. Then, set temperature to a Higher setting.</li> </ul>
Air conditioner cooling but room is too warm - No ice forming on cooling coil behind decorative front.	<ul style="list-style-type: none"> <li>• Dirty air filter- air restricted. Clean air filter. Refer to Care and Cleaning section.</li> <li>• Temperature is set too High, set temperature to a Lower setting.</li> <li>• Air directional louvers positioned improperly. Position louvers for better air distribution.</li> <li>• Front of units is blocked by drapes, blinds, furniture, etc. - restricts air distribution.</li> <li>• Clear blockage in front of unit.</li> <li>• An open doors, windows, or register may allow cold air to escape. Close any doors, windows, or registers.</li> <li>• The room may be too warm. Allow additional time to remove "Stored heat" from walls, ceiling, floor and furniture.</li> </ul>
Air conditioner turns on and off rapidly	<ul style="list-style-type: none"> <li>• Dirty air filter- air restricted. Clean air filter.</li> <li>• Outside temperature extremely hot. Set FAN speed to a Higher setting to bring air past cooling coils more frequently.</li> </ul>
Noise when unit is cooling	<ul style="list-style-type: none"> <li>• Air movement sound. This is normal . If too loud, set to a slower FAN setting.</li> <li>• Window vibration - poor installation. Refer to installation instructions or check with installer.</li> </ul>
Water dripping INSIDE when unit is cooling.	<ul style="list-style-type: none"> <li>• Improper installation. Tilt air conditioner slightly to the outside to allow water drainage. Refer to installation instructions - check with installer.</li> </ul>
Water dripping OUTSIDE when unit is cooling.	<ul style="list-style-type: none"> <li>• Unit removing large quantity of moisture from humid room. This is normal during excessively humid days.</li> </ul>
Remote Sensing Deactivating Prematurely (some models)	<ul style="list-style-type: none"> <li>• Remote control not located within range. Place remote control within 20 feet and pointed in the general direction of the air conditioner unit.</li> <li>• Remote control signal obstructed. Remove obstruction.</li> </ul>
Room too cold	<ul style="list-style-type: none"> <li>• Set temperature too low. Increase set temperature.</li> </ul>

# TROUBLESHOOTING & WARRANTY

## LIMITED WARRANTY

Any repair, replacement, or warranty service, and all questions about this product should be directed to W Appliance Co. at **1 (855) 855-0294** from the USA or Puerto Rico.

W Appliance Co. warrants to the original purchaser that the product will be free from defects in material, parts and workmanship for the period designated for this product. The warranty commences the day the product is purchased and covers up to a period of **1 year (12 months) for labor/1 year (12 months) for parts (manufacturing defects only)/and a total of 5 years (60 months) for compressor part only.**

W Appliance Co. agrees that it will, at its option, replace the defective product with either a new or remanufactured unit equivalent to your original purchase during the warranty period.

**Exclusions:** This warranty does not apply to the below:

1. If the appearance or exterior of the product has been damaged or defaced, altered or modified in design or construction.
2. If the product original serial number has been altered or removed or cannot be readily determined.
3. If there is damaged due to power line surge, user damage to the AC power cord or connection to improper voltage source.
4. If damage is due to general misuse, accidents or acts of God.
5. If repair attempts are done by unauthorized service agents, use of parts other than genuine parts or parts obtained from persons other than authorized service companies.
6. On units that have been transferred from the original owner.
7. On products that have been purchased as refurbished, like new, second-hand, in a "As-Is" or "Final Sale" terms.
8. To products used in a commercial or rental setting.
9. To products used in settings other than ordinary household use or used other than in accordance with the provided instructions.
10. To damages for service calls for improper installations.
11. To glass parts and other accessory items that are included with the unit.
12. Transportation and shipping costs associated with the replacement of the unit.
13. Food loss for loss due to product failure or delay in service, repair or replacement.
14. Service calls to instruct you how to use your product.
15. Service calls to repair or replace the house fuse, reset the circuit breaker or correct the wiring in the house.

REPAIR OR REPLACEMENT AS PROVIDED UNDER THIS WARRANTY IS THE EXCLUSIVE REMEDY OF THE CUSTOMER; W Appliance Co. SHALL NOT BE LIABLE FOR ANY INCIDENTAL OR CONSEQUENTIAL DAMAGES FOR BREACH OF ANY EXPRESS OR IMPLIED WARRANTY ON THIS PRODUCT, EXCEPT TO THE EXTENT PROHIBITED BY APPLICABLE LAW. ANY IMPLIED WARRANTY OF MERCHANTABILITY OF FITNESS FOR A PARTICULAR PURPOSE ON THIS PRODUCT IS LIMITED TO THE DURATION OF THE WARRANTY.

Some states do not allow the exclusion or limitations of incidental or consequential damages, or limitations on how long the warranty lasts. In these cases the above exclusions or limitations may not apply to you. This warranty gives you specific legal rights and you may also have other rights which vary from state to state.

**Obtaining Service:** To obtain service, product literature, supplies or accessories please call

**1 (855) 855-0294** to create a ticket for exchange/repair. Please make sure to provide the date of purchase, model number and a brief description of the problem. Our customer service representative will contact you or send detailed return instructions.

W Appliance Co. does not warrant that the appliance will work properly in all environmental conditions, and makes no warranty and representation, either implied or expressed, with respect to the quality, performance, merchantability, or fitness for a particular purpose other than the purpose identified within this user's manual. W Appliance Co. has made every effort to ensure that this user's manual is accurate and disclaims liability for any inaccuracies or omissions that may have occurred. Information in this user's manual is subject to change without notice and does not represent a commitment on the part of W Appliance Co.. W Appliance Co. reserves the right to make improvements to this user's manual and/or to the products described in this user's manual at any time without notice. If you find information in this manual that is incorrect, misleading, or incomplete, please contact us at **1-855-855-0294**.

W Appliance Co.,  
1356 Broadway  
New York, NY 10018





© 2019 Commercial Cool is a W Appliance Company.  
All Rights Reserved.  
0119