

MODEL NUMBER:

□ 7105.230 - Toilet Paper Holder

Available Finishes

002	Polished Chrome
295	PVD Brushed Nickel

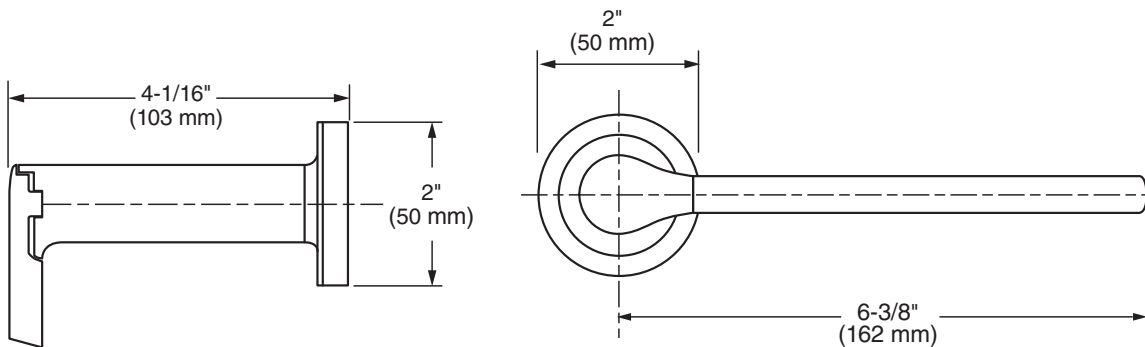

PRODUCT FEATURES:

Materials of Construction: Metal construction for durability & long life.

Concealed Mounting: No exposed set screws.

Easy to Install

Easy to Use

SUGGESTED SPECIFICATION

Toilet Paper Holder shall feature metal construction. Shall feature concealed mounting with no exposed set screws. Toilet Paper Holder shall be American Standard Model # 7105.230.____.