

Heart Table and Chair Set

Parts List

Item #26913A

Please retain this information for future reference

To order replacement parts, please visit www.kidkraft.com

HARDWARE

A. Hex Screw
x 32 pcs

(50 mm, 2 in)

B. Cam Bolt
x 4 pcs

(36 mm, 1 3/8 in)

C. Cam Lock
x 4 pcs

D. Cross Dowel Bolt
x 4 pcs

(58 mm, 2 1/4 in)

E. Cross Dowel Nut
x 4 pcs

Allen Wrench
x 1 pc

The following tool is required for assembly:

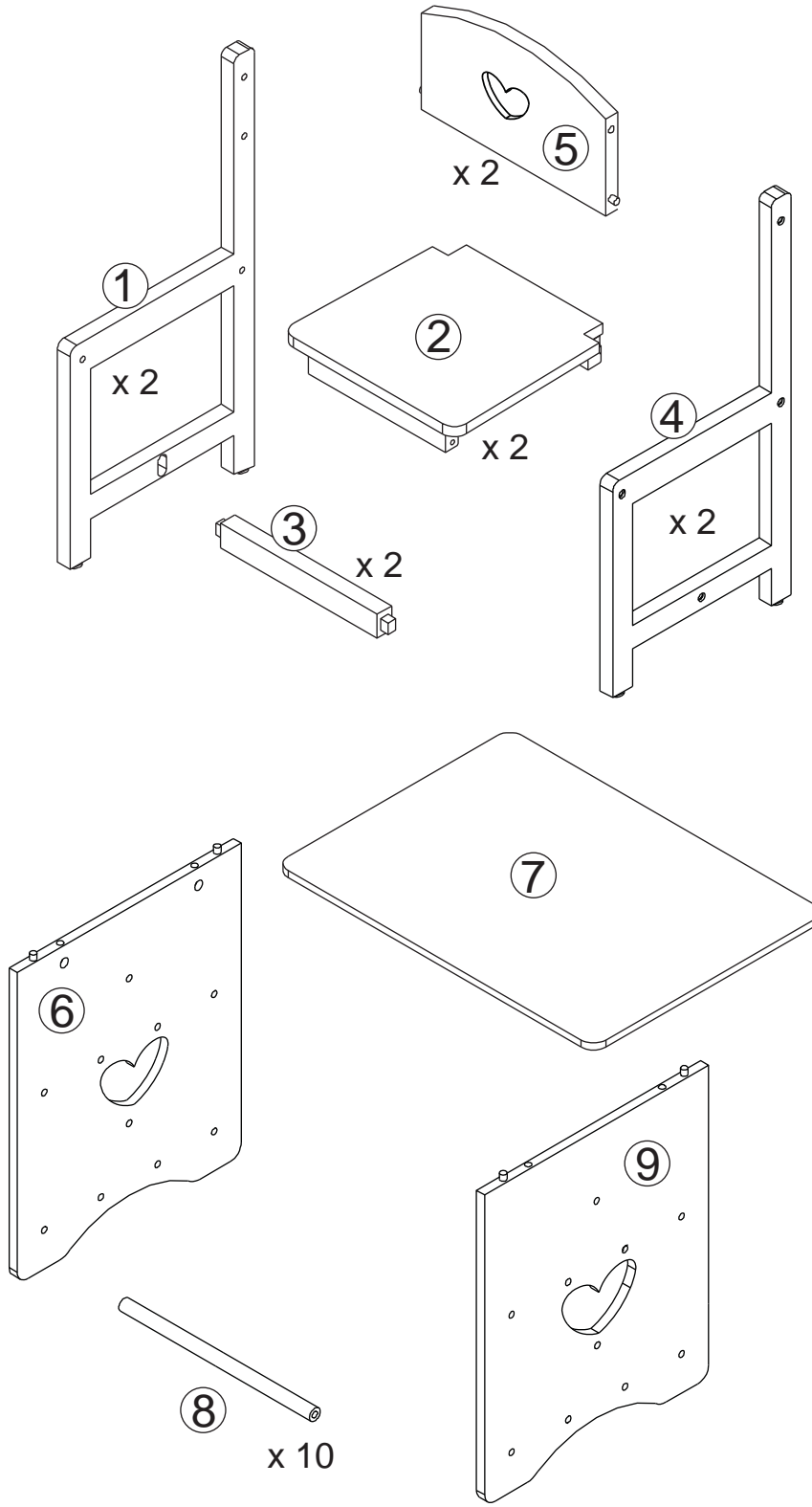
Phillips® Screwdriver

PARTS LIST:



1 x 2
2 x 2
3 x 2
4 x 2
5 x 2
6
7
8 x 10
9
10

Bin Assembly Instructions

NOTE: Once the two pieces of the plastic bin are connected, mechanism is permanent. Do not attempt to separate the two pieces once assembled.

Step 1
Place Bottom through Top.

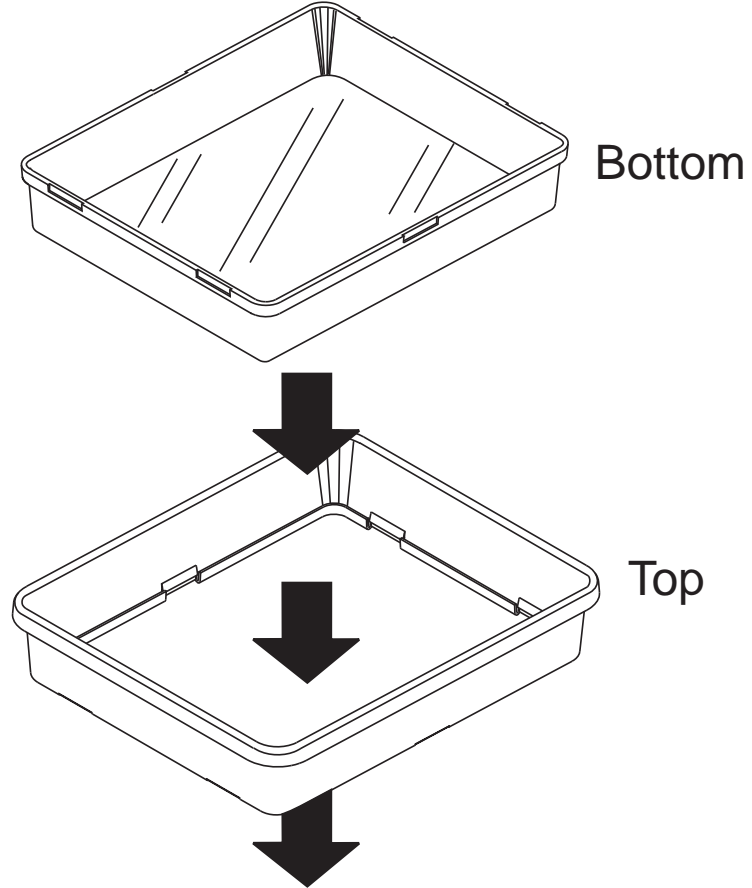

Bottom
Top

Step 2
Pull up Top with one hand and push down Bottom at the same time until the two parts lock. Make sure that the six "U" hooks have been securely locked.

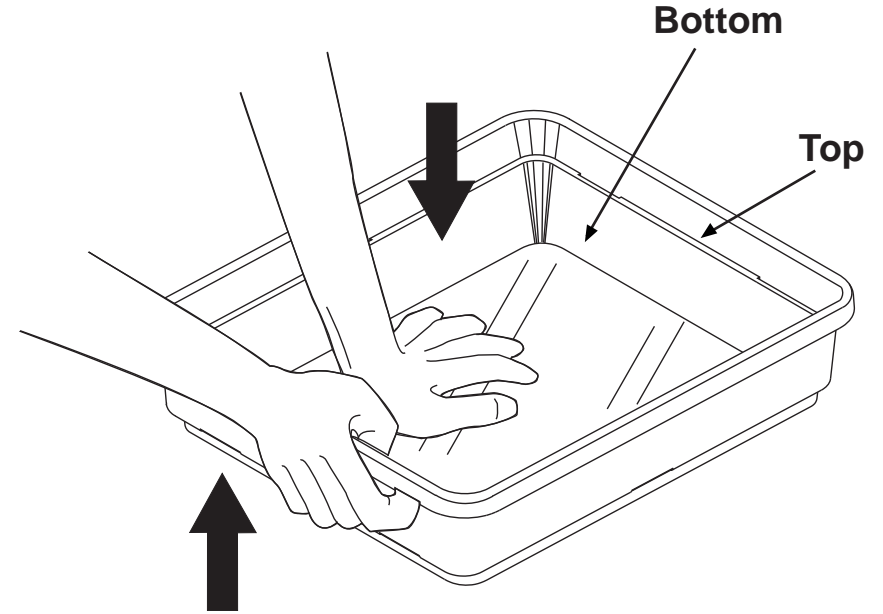

Bottom
Top

*Repeat for lavender bins.

Step 3

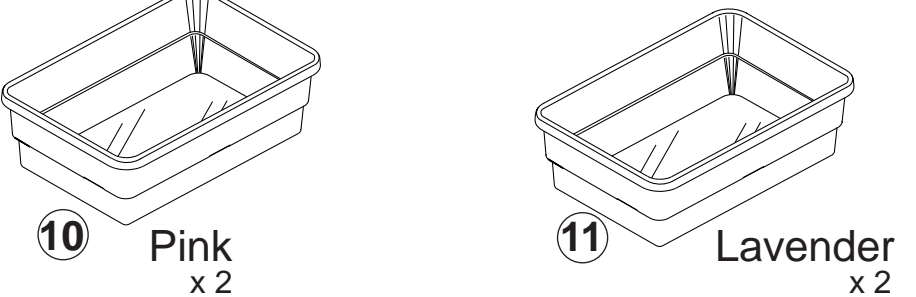

10 Pink x 2
11 Lavender x 2

Patent Pending

CAUTION:
ADULT ASSEMBLY REQUIRED. Hardware contains small screws with sharp points. Keep unassembled parts out of the reach of small children.

USE AND MAINTENANCE:
-Use on level surfaces only
-Please check assembly at regular intervals, and frequently tighten hardware if necessary. If maintenance is not carried out, the product could cease to function properly.

WARNING:
CHOKING HAZARD. Small parts and sharp points, not suitable for children under 3 years.

Customer Service
1-800-933-0771
www.kidkraft.com

Heart Table and Chair Set

Parts List

Item # 26913A

Please retain this information for future reference

<p>Step 1</p>	<p>Step 2</p>	<p>Step 3</p> <p>*Repeat steps 1 and 2 for second chair</p>	<p>Step 4</p>
<p>Step 5</p>	<p>Step 6</p>	<p>Step 7</p>	<p>Step 8</p> <p>*Insert bins under table.</p>



Warning: This is intended for children of a specific age or above. Keep children younger than the specified age from using this item. Do not let children of any age climb on or around this item. Adult supervision is always recommended.

IMPORTANT INFORMATION - PLEASE READ FIRST

ALL OF OUR WOODEN ITEMS ARE HANDCRAFTED, HAND ASSEMBLED, AND HAND PAINTED. EACH ONE IS UNIQUE. SLIGHT IMPERFECTIONS MAY OCCUR AND ARE NOT MANUFACTURING DEFECTS.

PLEASE NOTE THAT WE DO NOT WARRANTY AGAINST THE USE OF PERMANENT MARKERS, NON-WATER-BASED PAINTS, CRAYONS, OR WASHABLE MARKERS. SOME OF THESE ITEMS CONTAIN PERMANENT COLOR DYES THAT COULD DAMAGE THE SURFACE.

CLEANING INSTRUCTIONS

CLEAN THE SURFACE USING A SLIGHTLY DAMP CLOTH AND MILD DISH WASHING LIQUID IF NECESSARY. DO NOT USE ANY CLEANING PRODUCT CONTAINING ALCOHOL OR AMMONIA. THESE WILL DULL THE SHINY SURFACE OF THE PRODUCT. FURNITURE POLISH WILL ALSO WORK TO CLEAN AND DUST OFF THE SURFACE.

WE RECOMMEND THAT YOU TEST ALL CLEANING MATERIALS ON THE UNDERSIDE OF ANY SURFACE THAT WOULD NOT BE SEEN DURING NORMAL USE OF THE PRODUCT. IF YOU HAVE QUESTIONS REGARDING THE MAINTENANCE OF THIS PRODUCT PLEASE FEEL FREE TO CALL US.

SOLE AND LIMITED WARRANTY

THIS PRODUCT IS WARRANTED SOLELY AGAINST MANUFACTURING DEFECTS FOR A PERIOD OF 90 DAYS FROM THE DATE OF PURCHASE, WHICH RUNS ONLY TO THE ORIGINAL USER OF THE PRODUCT. IN THE EVENT OF A MANUFACTURING DEFECT, PARTS WILL BE REPLACED OR THE ENTIRE PRODUCT WILL BE REPLACED OR THE PURCHASE PRICE WILL BE REFUNDED, AT THE ELECTION OF THE MANUFACTURER. TO ACTIVATE AND PROTECT THIS WARRANTY, PRESERVE EVIDENCE OF ORIGINAL PURCHASE AND CAREFULLY INSPECT THE CONDITION OF THE PRODUCT PRIOR TO AND AFTER ASSEMBLY, LOOKING FOR MISSING, DEGRADED, BROKEN, IMPROPERLY SIZED OR HAZARDOUS PARTS, INCLUDING PARTS WHICH CAN BE SWALLOWED BY A CHILD, CAUSE A CHILD TO CHOKE, OR OTHERWISE CAUSE INJURY. SUCH PARTS MAY INCLUDE LOOSE SCREWS, EXPOSED NAILS OR SHARP EDGES. SHOULD YOU OBSERVE ANY DEFECTS, DO NOT USE THE PRODUCT AND IMMEDIATELY NOTIFY THE MANUFACTURER. FAILURE TO DO SO SHALL CONSTITUTE MISUSE. MISUSE, IMPROPER ASSEMBLY, FAILURE TO HONOR A WARNING, FAILURE TO SUPERVISE, INSPECT OR MAINTAIN THE PRODUCT, OR DAMAGE TO THE PRODUCT, WHETHER INTENTIONAL OR INADVERTENT, SHALL INVALIDATE THIS WARRANTY. THIS WARRANTY GIVES YOU SPECIFIC LEGAL RIGHTS, AND YOU MAY ALSO HAVE OTHER RIGHTS WHICH VARY FROM STATE TO STATE.

TO SUBMIT A WARRANTY CLAIM PLEASE CONTACT KIDKRAFT CUSTOMER SERVICE AT 1-800-933-0771 FOR INSTRUCTIONS ON HOW TO PROVIDE PROOF OF PURCHASE AND HOW TO RETURN THE ITEM FREIGHT PRE-PAID.

CUSTOMER SERVICE 1-800-933-0771

www.kidkraft.com