

PAMAPIC

INSTRUCTION MANUAL

11 Ft x 11 Ft Pop Up Canopy With Netting

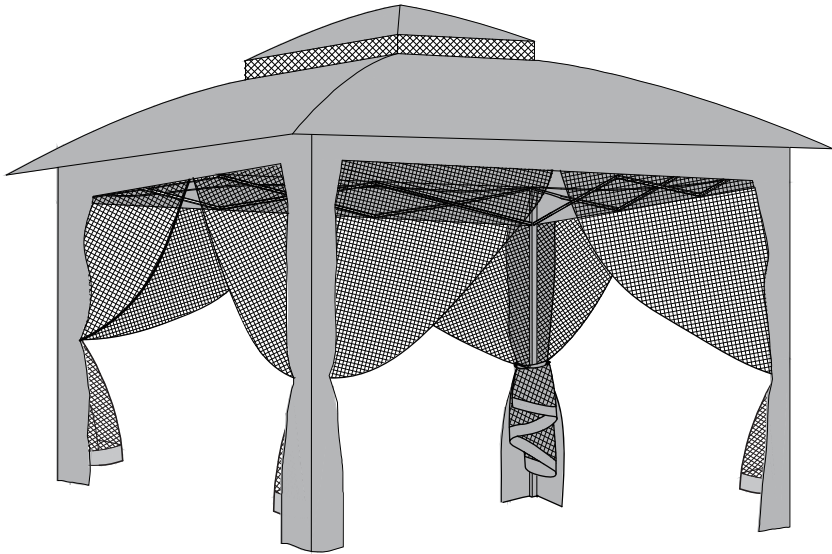

If you have any problem, please do not hesitate to contact us via

email: ***Pamapic@hotmail.com***

www.Pamapic.com

WARRANTY

Please read and save these instructions before attempting to set up this canopy.

1 year limited warranty

Please email Pamapic@hotmail.com before returning the product to our shop.

Pamapic warrants for a period of 1 year from the original date of purchase, this product against any defects in materials or workmanship. At its discretion, Pamapic may provide replacement parts to original purchaser. Original receipt or proof of purchase as well as proof of defect is required. Pamapic will not be responsible for shipping costs incurred outside the continental USA. Warranty is valid for the original purchaser for 1 year from the date of purchase and is not transferable.

This Warranty Does Not Cover

This 1 Year Limited Warranty does not cover normal wear and tear, abuse or misuse of this product including damage from inclement weather conditions, such as wind, rain, or hail. In case of inclement weather, take down and store the canopy, remove and store valuables, and seek appropriate shelter.

Under no circumstances will Pamapic be liable or responsible for any incidental or consequential damages.

This product is designed and intended for commercial and recreational usage. Pro-longed exposure to UV rays will cause any fabric to fade and deteriorate and is NOT covered by this 1 Year Limited Warranty.

All replacement products or parts will assume the remaining warranty of the original product. This warranty gives you specific legal rights. You may also have other rights, which vary from state to state.

It is your responsibility to read and save these instructions before attempting to set up your commercial canopy. We would also like to suggest that you follow these safety precautions, care and maintenance tips when using your canopy.

1. Never set up or continue to use in any rain, wind or storm conditions, especially lightning storms. Damage can occur to your canopy and put you and others in potential danger.
2. We suggest that you take your time in order to avoid bending the frame or pinching your fingers or hands while opening and closing the frame.
3. Avoid setting up your canopy on steep inclines.
4. Do not use your canopy for permanent shelter. It is designed for temporary use only.
5. Keep your canopy away from heat and flames at all times. Do not barbecue or build fires under your canopy.
6. Never leave your canopy unattended.
7. Hand wash the canopy using only mild soap and water. Never use harsh detergents, abrasives or bleach. Do not machine wash fabric components.
8. Never fold or store your canopy when it is wet or damp. Let it dry completely to avoid mildew.
9. The frame **MUST** be staked or properly weighted down at all times.

Like our Facebook Page (@Pamapic.fans)

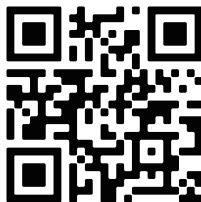

PACKING INCLUDES

Part List

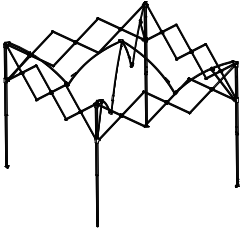

A - Canopy Frame (1pc)

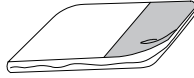

B - Big Top (1pc)

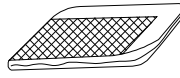

C - Mosquito Netting (1pc)

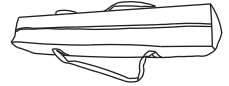

D - Carry Bag (1pc)

Hardware



AA - Stake (8pcs)



BB - Rope (4pcs)

ATTACH THE BIG TOP

Step 1

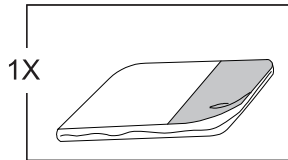
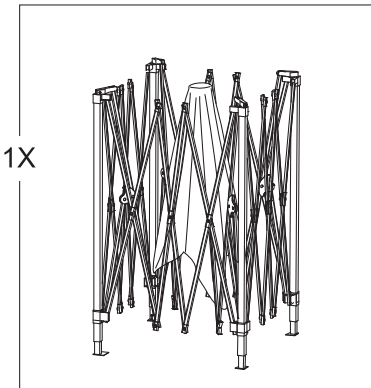

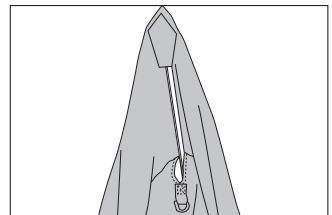
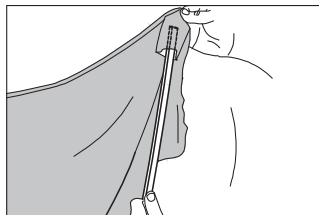
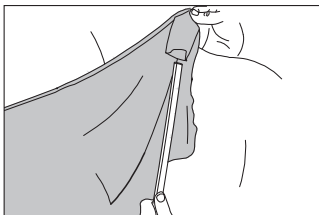
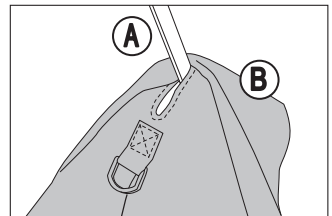
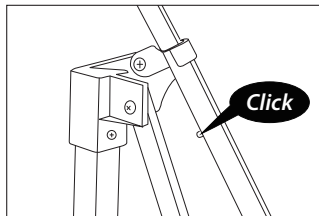
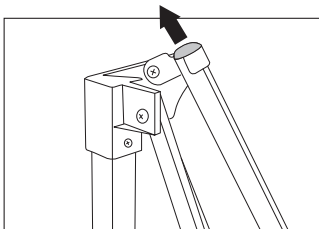
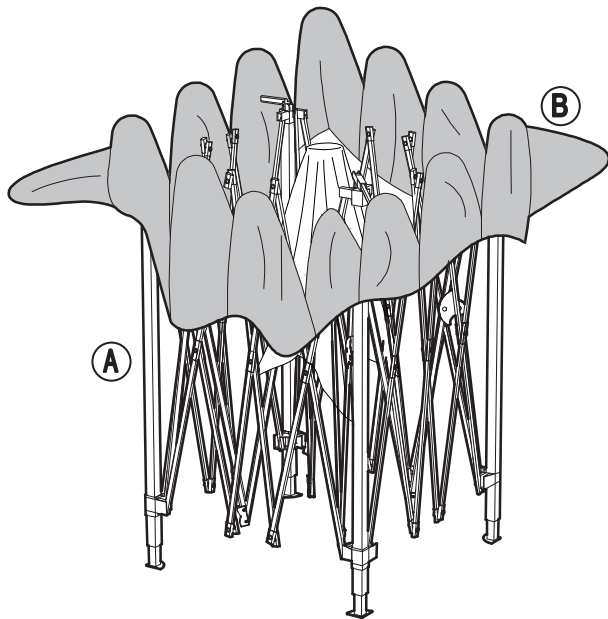

ATTACH THE SMALL TOP & UNFOLD THE CANOPY

Step 2

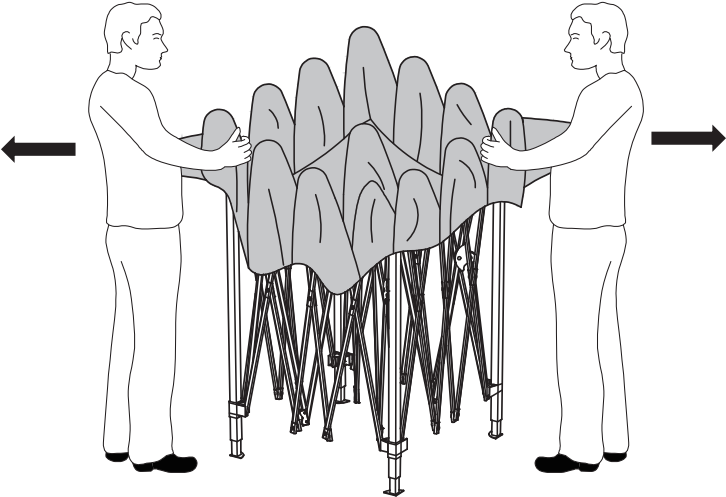

LOCK THE FRAME BEFORE ADJUSTING THE HEIGHT OF THE CANOPY

Step 3

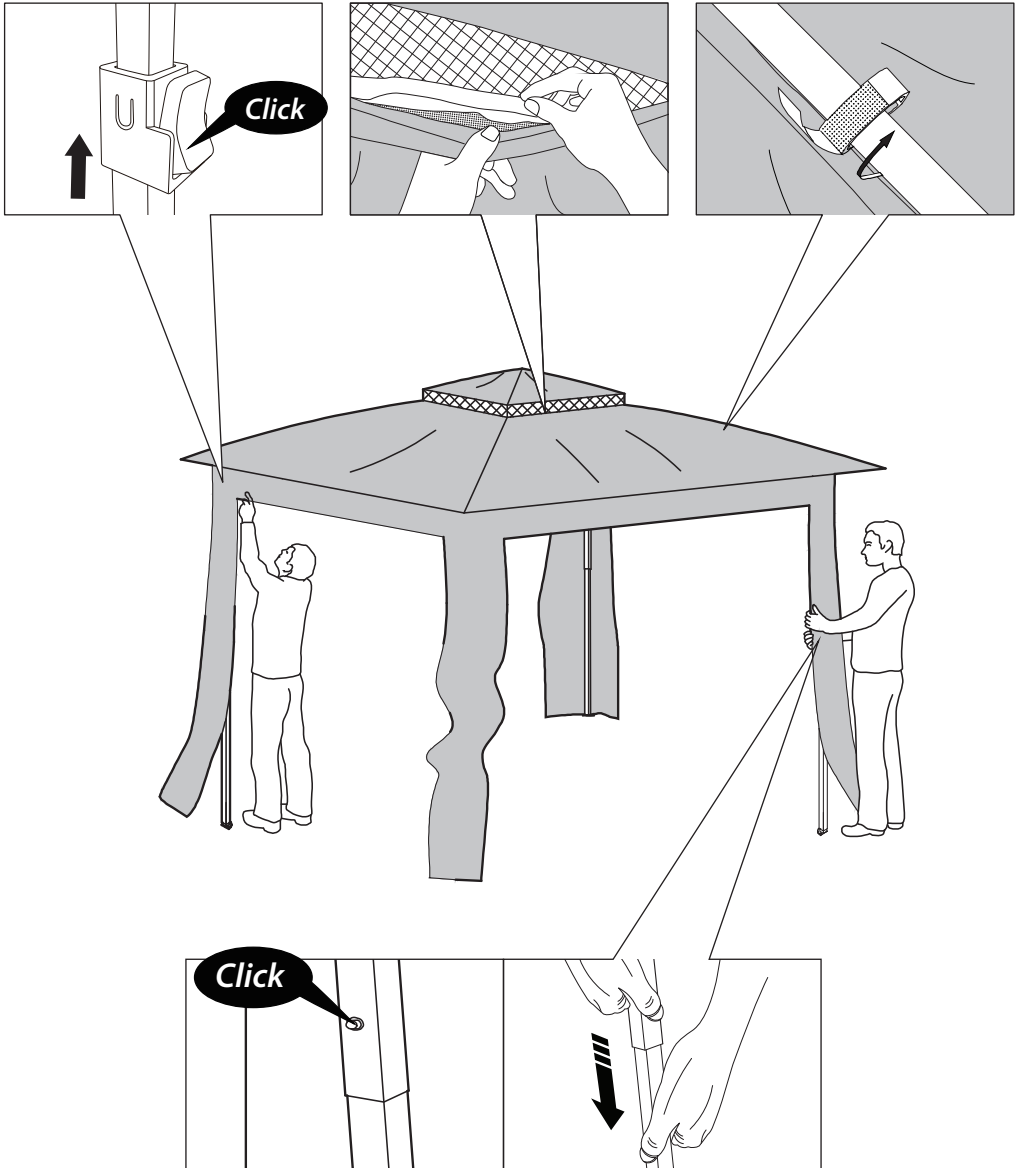

INSTALL MOSQUITO NET ACROSS THE OUTSIDE OF LEG ASSEMBLY

Step 4

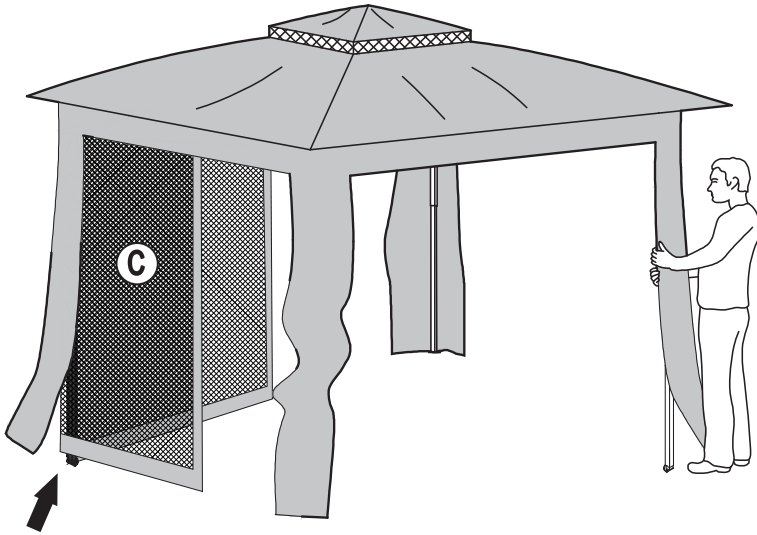
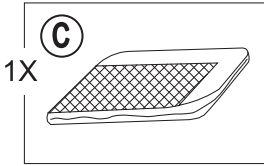

Install mosquito net across the
outside of leg assembly

ATTACH THE MOSQUITO NETTING

Step 5

You will need:

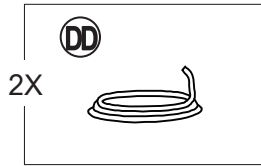

- Secure the ends of the ropes to adjacent corners of the frame above each leg by tying a knot.
- Reinforce the ropes on each side by securing them with the included velcro straps.
- Finish attaching the large canopy inside the canopy frame using the Velcro loops.

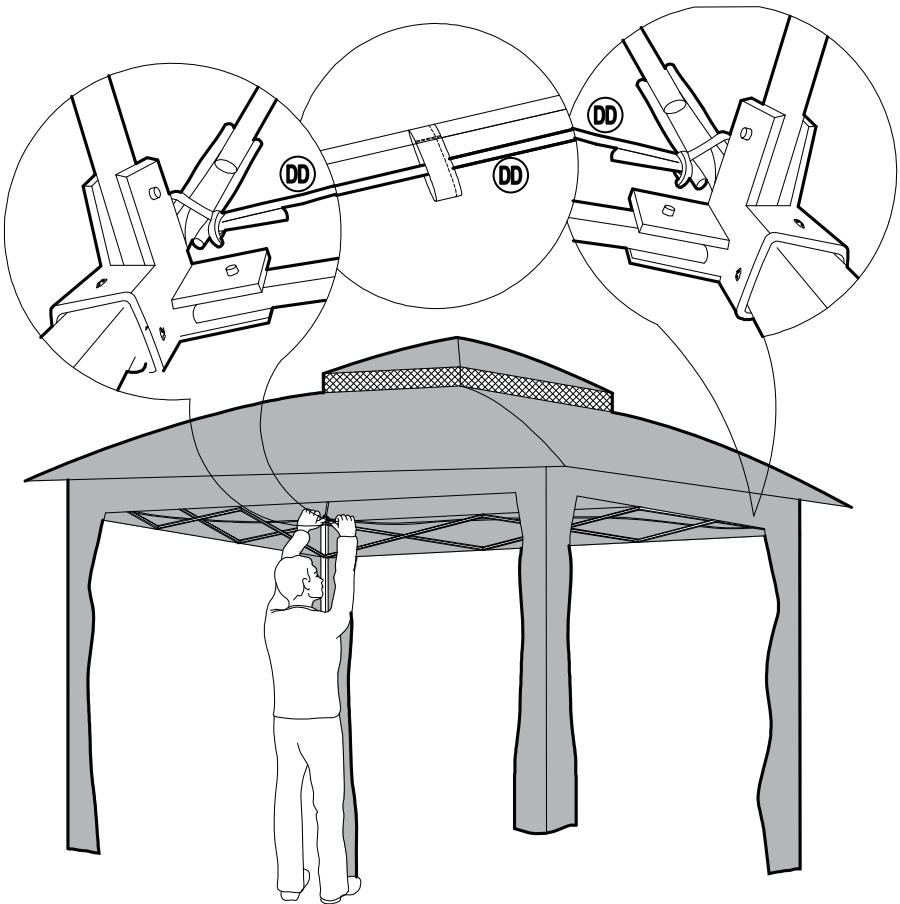

You will need:

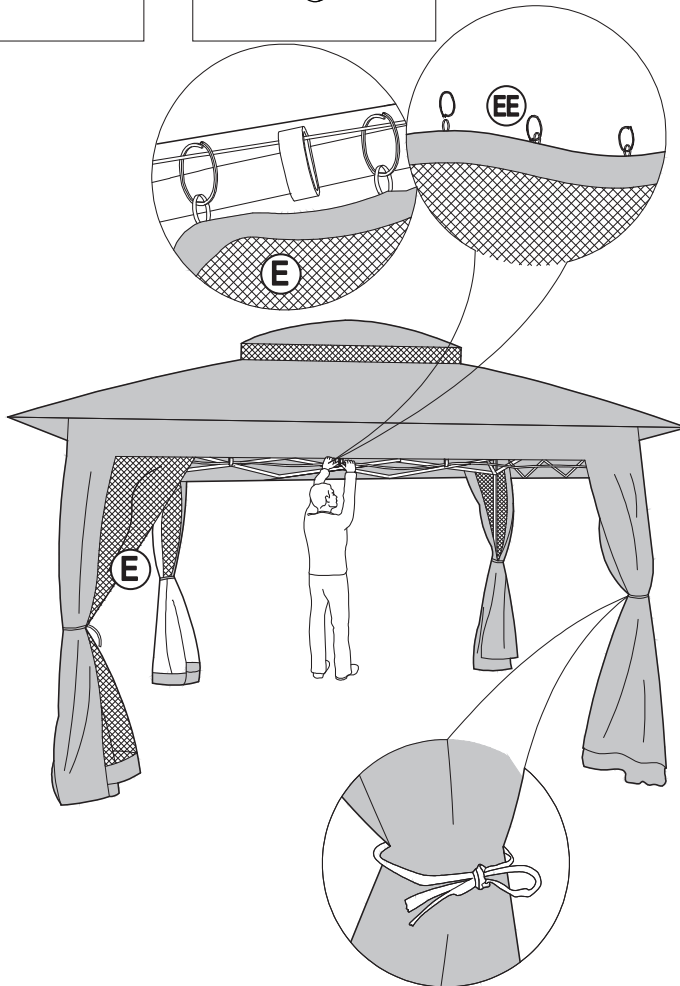
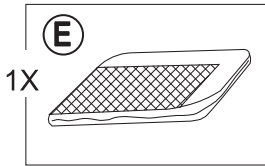

- Open the curtain rings and loop them through the sewn-in loops on the top edge of the mosquito netting.
- Secure the mosquito netting to the ropes using the curtain rings. Continue around the canopy until the entire mosquito net is secured.
- The netting/curtains can be tied back once attached.

SECURE THE CANOPY IN PLACE

Step 6

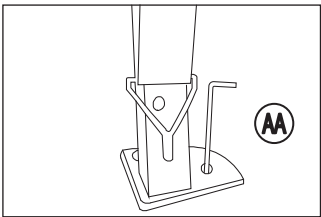
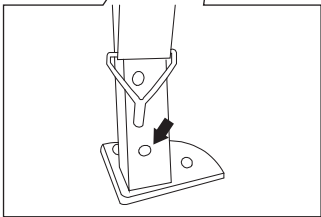
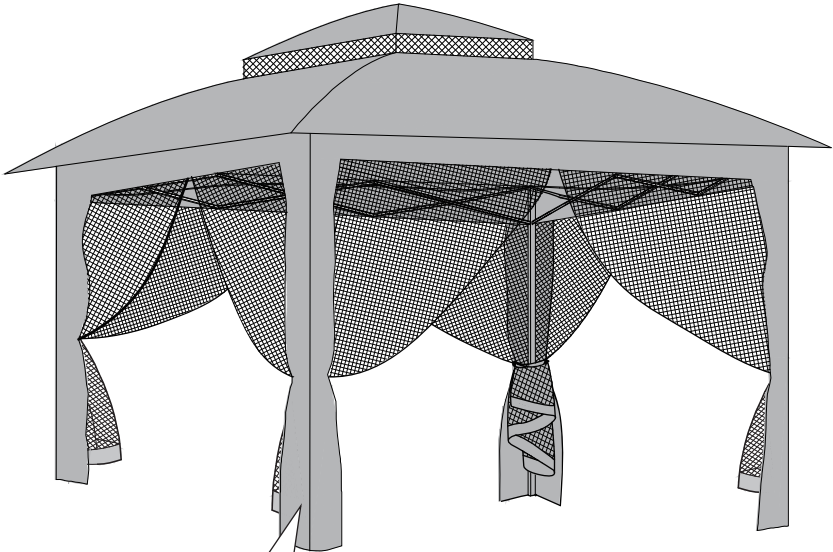
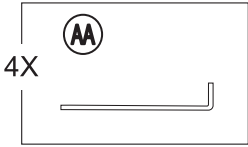

SECURE THE CANOPY IN PLACE

Step 7

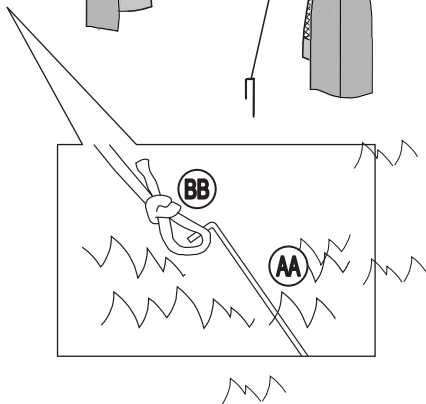
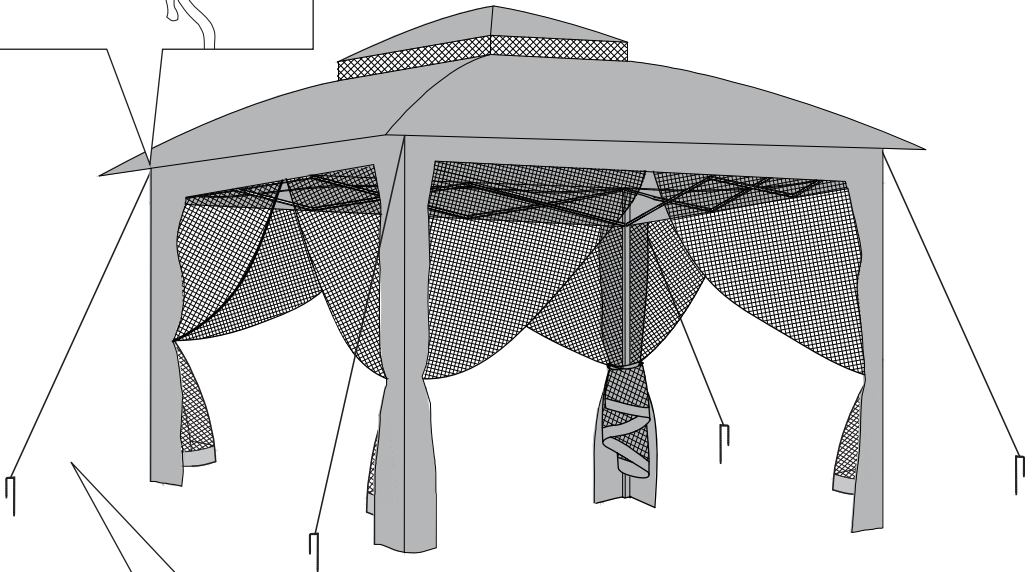
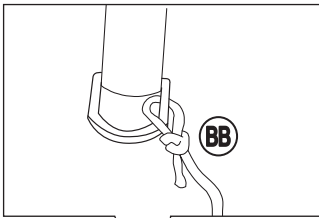
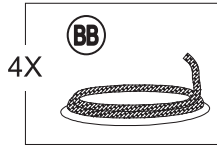
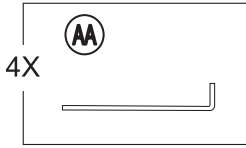

TAKE DOWN THE CANOPY

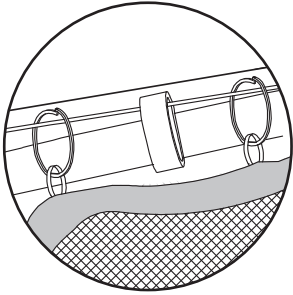

- 1** Remove the mosquito netting if attached.

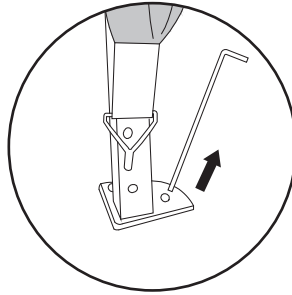

- 2** Pull up all stakes from the ground.

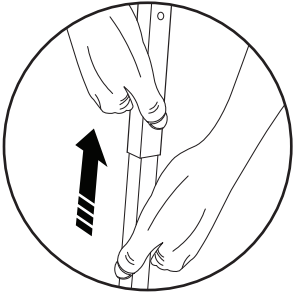

- 3** Press the push pin on each leg and retract the legs to their original height.

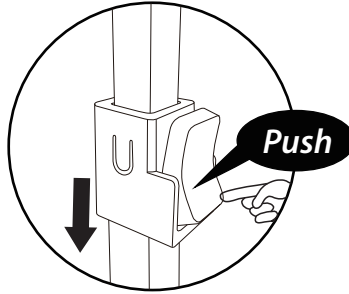

- 4** Push the push button on each slider to unlock the frame.

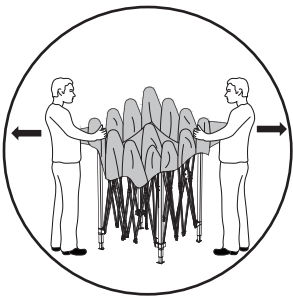

- 5** Push inward until the frame is fully closed.

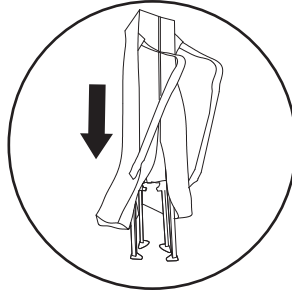

- 6** Slide the carry bag over the closed frame and close the zipper on carry bag.