

10 YEAR MANUFACTURER'S LIMITED WARRANTY

All parts of this Elements Of Design faucet are warranted to the original retail purchaser to be free from defects in material and workmanship for a period of ten(10) years from the date of purchase as shown on the purchaser's receipt. This warranty is limited to defective parts only, labor charges and/or damage resulting from improper installation, repair or replacements, as well as incidental and consequential damages connected therewith are excluded.

Any damage to this faucet as a result of misuse, abuse, neglect, accident for improper installation or any use not consistent with the instructions furnished by Elements of Design, will void this warranty. Replacement parts can be obtained from your local dealer.

CAUTION!!!

1. Water lines must be completely flushed before use, to avoid bris & clogs in your water system leading to mal-function and reduction of water flow.
2. Warranty to be void if water lines are not flushed before use of new faucet.
3. Use of abrasives of any strength may damage the finish of your faucet and void this warranty.

CODE APPROVAL: LA#M-000018



T 909.465.6687 F 909.548.6843 1877.FAUCET.1
www.eodfaucet.com
email: support@eodfaucet.com

INSTALLATION SHEET

Heritage Collection Towel Bar Installation

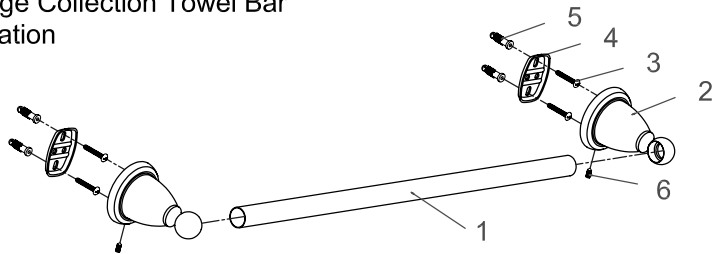

PART NAME	QUANTITY	PART NAME	QUANTITY
① Bar	1	④ Mounting Plate	2
② Base	2	⑤ Anchor	4
③ Mounting Screw	4	⑥ Slotted Set Screw	2

Installation Steps:

- Step 1. Locate position on the wall and mark outline of cover plate on the wall. (Fig.1)
- Step 2. Unscrew Slotted Set Screw at base and remove mounting plate.
- Step 3. Locate mounting plate in the center of outline. Mark location of the mounting screw (Fig.2) and drill holes at the marked location.
- Step 4. Insert anchors into the holes until flush with wall. (Fig.3)
- Step 5. Screw the mounting plate to wall with mounting screw. (Fig.4)
- Step 6. Repeat steps from 3 to 5 to another side.
- Step 7. Place the unit, with the small hole of cover plate underneath, over the mounting plate by tightening slotted set screw with flat head screwdriver until the base is tightly fixed. (Fig.5)

MODEL	FINISH	MODEL	FINISH
BA 1751 & 1752C	Chrome	BA 1751 & 1752ORB	Oil Rubbed Bronze
BA 1751 & 1752PB	Polished Brass	BA 1751 & 1752AB	Antique Brass
BA 1751 & 1752SN	Satin Nickel	BA 1751 & 1752PN	Polished Nickel

TOOLS REQUIRED

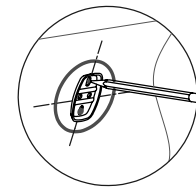
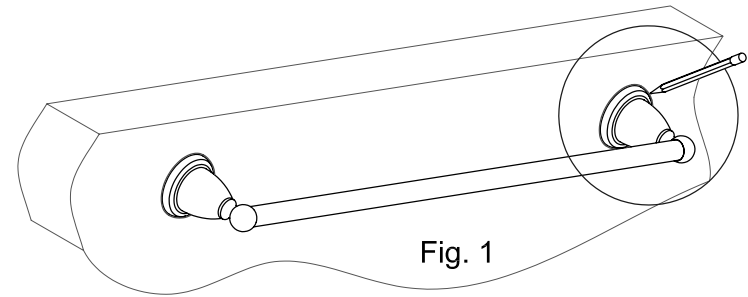
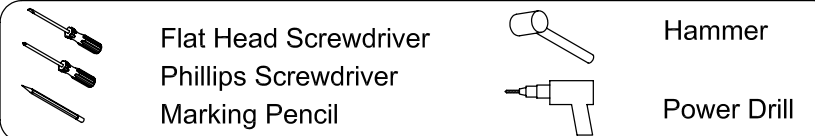

Fig. 2

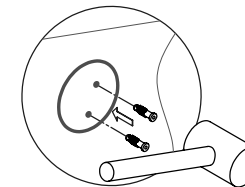

Fig. 3

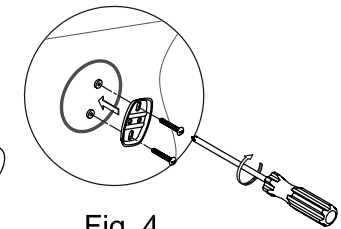

Fig. 4

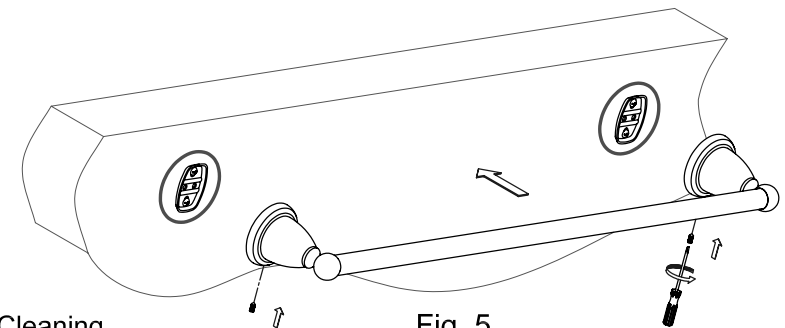

Fig. 5

Cleaning

Clean with a damp cloth only.
Avoid using metal or abrasive polishes.

www.kingstonbrass.com

TOLL-FREE CUSTOMER SERVICE: 877-2-KBRASS

TECHNICAL SUPPORT E-mail: service@kingstonbrass.com

6240 Prescott Court, Chino, CA91710