

# Vinotemp®

A PROUD HERITAGE OF EXPERIENCE & QUALITY



**2 BOTTLE WINE DISPENSER**  
DISPENSER & PRESERVER  
VT-WINEDISP2

OWNER'S MANUAL



WWW.VINOTEMP.COM

## SERVING WINES

Storing wines at the proper temperature is important. To preserve them as long as possible wine should be stored at approximately 55° Fahrenheit. However, the chart below suggests the optimal drinking temperature for the different styles of wine.

°C	°F	Wine Style
19	66	Armagnac, Brandy, Cognac
18	64	Full Bodied Red Wines, Shiraz
17	62	Tawny Port
15	59	Medium Bodied Red Wines
14	57	Amontillado Sherry
13	55	Light Bodied Red Wines
12	54	Full Bodied White Wines
11	52	Medium Bodied White Wines
10	50	Rosé, Light Bodied White Wines
9	48	Vintage Sparkling
8	46	Fino Sherry
7	45	Non Vintage Sparkling

## **General Operating Instructions**

Remove all external and internal packaging from your appliance. Be sure that all parts have been included before discarding any packaging materials. You may want to keep the box and packing materials for use at a later date.

Upon receipt and inspection of unit, the supply cord must be replaced if it is damaged. Contact our customer service at 1-800-777-8466 or [info@vinotemp.com](mailto:info@vinotemp.com).

**NOTE: Before connecting your wine dispenser to the power source, let the unit stand upright for 24 hours.** This will reduce the possibility of a malfunction in the cooling system from handling during transportation.

**READ ALL INSTRUCTIONS BEFORE USING THIS APPLIANCE**

**- Save these instructions -**

**To register your product, visit: <http://www.vinotemp.com/Warranty.aspx>**

**Register your warranty within 10 days of receiving the unit.**

**Please be sure to retain your proof of purchase.**

## TABLE OF CONTENTS

IMPORTANT SAFETY INSTRUCTIONS .....	5
ELECTRICAL CONNECTION .....	6
PARTS AND SPECIFICATIONS .....	7
INSTALLATION INSTRUCTIONS.....	8
OPERATING YOUR WINE DISPENSER .....	8
CARE AND MAINTENANCE .....	10
CIRCUIT DIAGRAM.....	11
TROUBLESHOOTING GUIDE .....	12
TERMS OF SALE AND WARRANTY.....	14



# IMPORTANT SAFETY INSTRUCTIONS

To reduce the risk of fire, electrical shock or injury when using your appliance, follow these basic precautions:

- Read and follow all instructions before use.
- Do not operate this or any other appliance with a damaged cord.
- Always unplug the appliance before performing any care or maintenance.
- Exercise caution and use reasonable supervision when appliance is used near children. Never allow children to operate, play with or crawl inside the appliance. Keep packing materials away from children.
- Do not clean appliance with flammable fluids. Do not store or use gasoline or other flammable vapors and liquids in the vicinity of this or any other appliance. The fumes can create a fire hazard or explosion.
- To clean, only use mild detergents or glass cleaning products. Do not use solvent-based cleaning agents or abrasives.
- Do not operate with housing panels removed or damaged.
- When disposing of refrigerated appliances, special handling is often required. It is the consumer's responsibility to comply with federal and local regulations when disposing of this product.
- Do not attempt to repair or replace any part of your appliance unless it is specifically recommended in this manual. All other servicing should be referred to a qualified technician.
- Locate the unit away from direct sunlight and sources of heat (stove, heater, radiator, etc).
- Do not use this appliance for other than its intended purpose.
- Do not store food in cabinet.
- Do not place any other appliance on top of the unit.
- For adult use only.
- Do not lift or carry the wine dispenser by the cord.
- Do not plug in to the power socket before setup is complete.
- When positioned or if moving the appliance, ensure that it is not set horizontally, positioned at an angle of more than 45°, or turned upside down.
- Place the appliance on a solid, level surface. Allow for proper clearances on all sides of the unit.
- The wine dispenser is an electrical appliance. To avoid injury or death from electrical shock, do not operate the unit with wet hands, while standing on a wet surface or while standing in water.
- Allow unit to stand upright for 24 hours prior to first plugging it in.
- This unit is designed for indoor, household use only. Any other use will void the warranty.

**WARNING:** Risk of child entrapment and suffocation. Before you throw away this or an old unit, take off the door. Leave the shelves in place, so that children may not easily climb inside.

**WARNING:** Gas bottle contents under pressure. Do not puncture or incinerate. Keep away from heat and out of direct sunlight. Keep away from sharp objects that could puncture chamber. Do not store in an enclosed vehicle. Do not discharge towards face or body. **KEEP OUT OF REACH OF CHILDREN.**

# ELECTRICAL CONNECTION

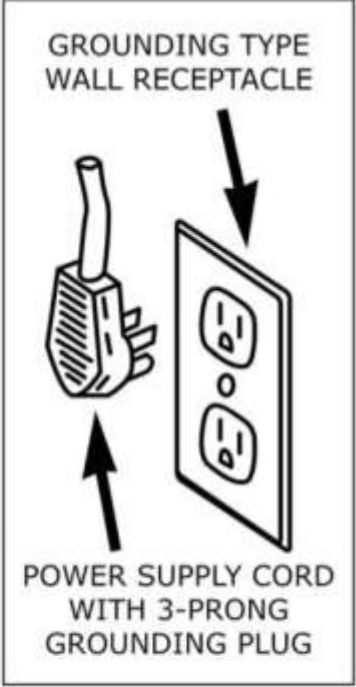
<b>⚠ WARNING</b>	
	<b>ELECTRIC SHOCK HAZARD</b> Disconnect electric supply from appliance before servicing. Replace all panels before operating. Failure to do so could result in death or electrical shock.
<b>To avoid the risk of electrical shock, property damage, personal injury or death:</b>	
<ul style="list-style-type: none"><li>• The power cord must be plugged into a 3-prong grounding -type wall receptacle, grounded in accordance with the National Electrical Code, ANSI/NFPA 70 - latest edition and local codes and ordinances.</li><li>• It is the personal responsibility of the consumer to have the proper 3-prong wall receptacle installed by a qualified electrician.</li><li>• <b>DO NOT, UNDER ANY CIRCUMSTANCE, REMOVE THE POWER CORD GROUNDING PRONG.</b></li><li>• A separate adequately fused and grounded circuit should be available for this appliance</li><li>• Do not remove any grounding wires from individual components while servicing, unless the component is to be removed and replaced. It is extremely important to replace all grounding wires when components are replaced.</li></ul>	 <p>GROUNDING TYPE WALL RECEPTACLE</p> <p>POWER SUPPLY CORD WITH 3-PRONG GROUNDING PLUG</p>
<ul style="list-style-type: none"><li>• <b>DO NOT USE A GROUND FAULT INTERRUPTER (GFI)</b></li><li>• <b>A DEDICATED 15 AMP CIRCUIT IS HIGHLY RECOMMENDED</b></li></ul>	

## Electrical Cord

We strongly recommend against the use of an extension cord. However, if you still elect to use an extension cord, it is necessary that it be a properly rated UL-listed, 3-wire grounding type appliance extension cord with a 3-blade grounding plug and a 3-slot receptacle.

## PARTS AND SPECIFICATIONS

This refrigerated wine dispenser displays, stores and dispenses 2 opened wine bottles, keeping them fresh from oxidation for up to 45 days. Wines can be maintained at a chosen storage and serving temperature, between 45° and 65°F. NSF-approved plastic components, sanitary stainless steel spouts and electronic valves keep wines clean and prevent any drips from spouts. Easily dispense a perfect glass of wine at any time with just the touch of a button.

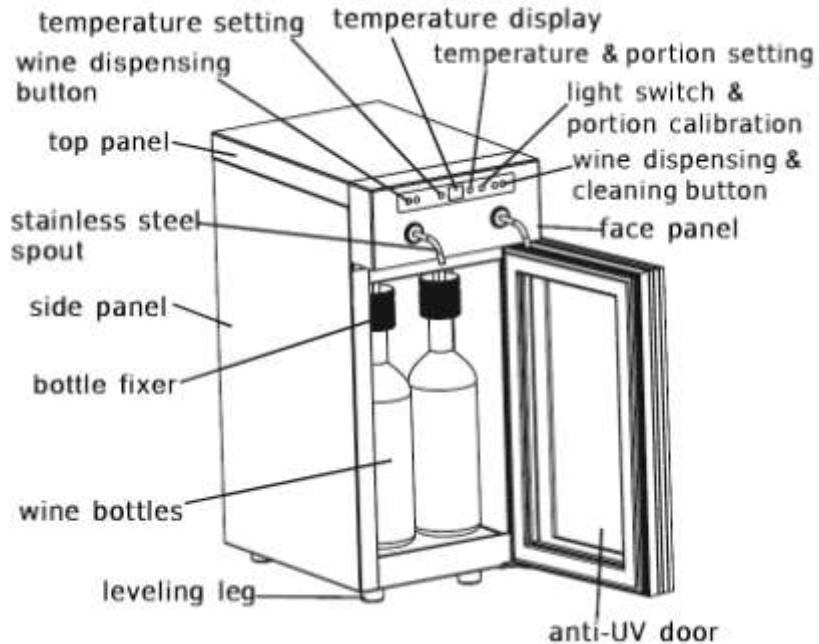

Model No.	VT-WINEDISP2
Voltage	AC 120V
Frequency	60 Hz
Cooling Power	85W
Refrigerant	R134a
Protection Class	I
Adjustable Temperature Range	45°-65°F (7°-18°C)
Ambient Temperature Range	45°-90°F (7°-32°C)
Bottle Capacity	2
Maximum Bottle Shelf Life	45 days
Approx. Dimensions (W x D x H)	9.3" x 16.28" x 20.7"

**NOTE:** Argon and nitrogen gas cartridge (gas weight of approximately 14 grams) not included. Suitable standard gas cartridges are non-refillable and have a threaded neck size of 1/2"-20 and minimum length of 0.5". The cartridge must have a diameter not exceeding 1.75" and a length not to exceed 5.5".

# INSTALLATION INSTRUCTIONS

## Before Using Your Unit

- Remove all packing material before using your wine dispenser. Check to be sure the appliance is in good condition.
- Use a soft, dry cloth to wipe down the outside of the wine dispenser thoroughly.
- **Before connecting your wine dispenser to the power source, let the unit stand upright for 24 hours.** This will reduce the possibility of a malfunction in the cooling system from handling during transportation.

## Locating Your Unit

- The wine preserver-dispenser is designed for free-standing installation only.
- It is recommended that this unit be kept in a location with an ambient temperature range of 45°F-90°F. Not intended for garage or basement installation.
- Place your wine dispenser on a solid, level surface (other than carpet). This will ensure vibration and noise-free operation. Use the adjustable legs to ensure that the unit is level.
- Leave a 5-inch clearance on all sides of the unit. This is to ensure proper circulation.

# OPERATING YOUR WINE DISPENSER

## Loading/Unloading Argon/Nitrogen/Inert Gas Bottle

1. Press and hold the wine dispensing button  to empty the remaining gas in the cartridge.
2. Unplug the unit.
3. Rotate the cover upwards to access the gas cartridge.
4. Pull the cartridge and turn it counter-clockwise to loosen.
5. Place a new cartridge and align it to the neck thread of the regulator. To properly position the cartridge, rotate once clockwise, and once aligned continue to turn clockwise to tighten.
6. Move the cartridge back and close the cover.

**Note:** It is normal that a little gas escapes when the gas cartridge is being tightened to the regulator.

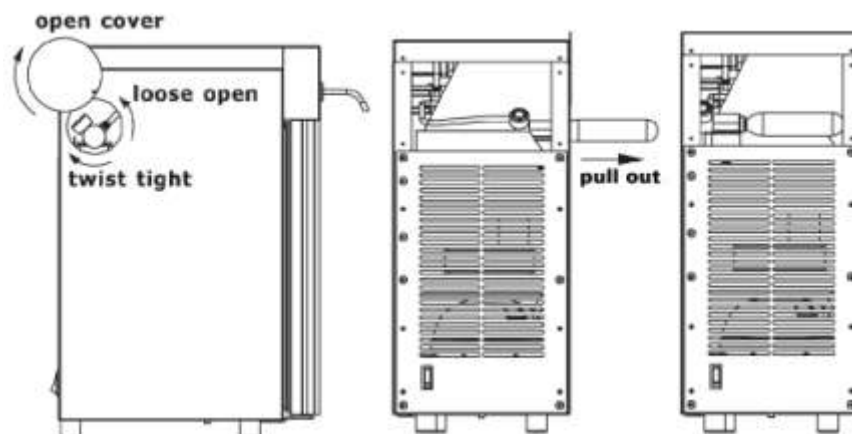



## Attaching and Removing Wine Bottles

1. Unscrew lower part of bottle fix nut and place it on the neck of desired wine bottle.
2. Slide bottle upward, with gas and wine tube inside the bottle.
3. Fit bottle mouth into silicon plug. If bottle mouth is larger, lift upper part of bottle fix nut to free silicon plug completely and ease bottle mouth into the silicon plug first.
4. Tighten lower part of bottle fix nut to the upper part.
5. Press the dispensing button to allow wine out and check to see if gas leakage will occur. (Reconnect tighter if needed so gas does not escape.)
6. Place wine fully in refrigerated cabinet and close door.

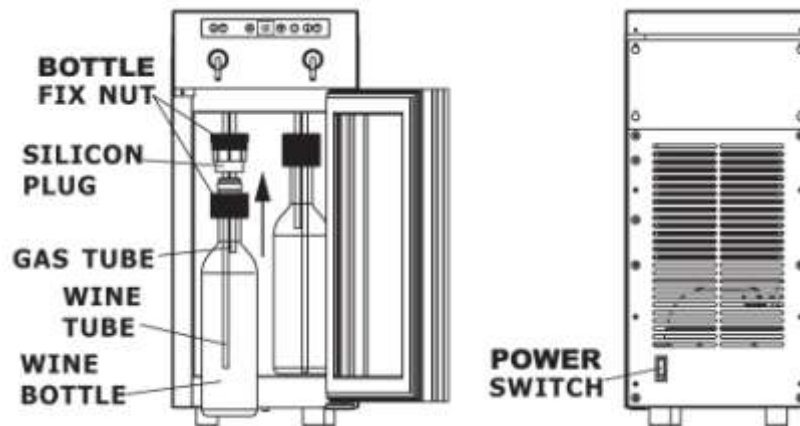











Once the wine dispenser is positioned and plugged in, turn the power on.





## Dispensing Wine

The wine dispenser features two sets of two dispensing buttons, each positioned directly above its corresponding wine bottle spout. The two dispensing button options are:

-  Press and hold the  button over the desired spout to begin dispensing wine into your glass. Wine will continue to be dispensed until the button is released.
-  Press the  button to dispense wine in 1oz increments. Press it once to dispense 1oz, twice to dispense 2oz, and so forth.
- Resetting the 1 oz. portion control setting: The 1 oz. preset portion control setting can be reset by the user. To set the portion control, press and hold the  button until the display shows "H2" and the previously set portion amount begins to flash. Using the  or  buttons, you can increase or decrease the portion control settings in 1 oz. increments until you reach your desired setting.
- Calibrating the portion: If the amount of wine dispensed varies, additional calibration may be used to correct the dispensed portion of wine. To calibrate the portion control setting, press and hold the  button until the display shows "H3" and the previously set portion control amount begins to flash. Using the  or  buttons, you can increase or decrease the portion control settings if necessary. Once you have checked the portion control setting, press the  button to dispense wine and verify the amount poured. **Note:** You may need to repeat this procedure several times until the correct portion is dispensed.

## Setting the Temperature

The temperature display will show the current temperature inside the unit. To set a temperature, press and hold the  button till the display shows “H1” and the displayed temperature starts to flash. Once the temperature display starts to flash, use the  or  buttons to select your desired temperature.

For wine to stay fresh up to 45 days, bottles must be closed and unit preservation system must be properly sealed to prevent deterioration. Keep wine at proper temperature in unit.

## LED Light



The LED light can be switched on or off by pressing the  button.

# CARE AND MAINTENANCE

**IMPORTANT:** Always unplug your wine dispenser before cleaning or performing maintenance. Never use harsh cleansers or scouring pads to clean any part of the wine dispenser.

## Cleaning

To clean the stopper dispenser and solenoid valve:

1. Fill a bottle with clean warm water and place the stopper-dispenser onto the bottle.
2. Press and hold the  button to begin dispensing the warm water.
3. To start the automatic cleaning setting, press the portion  button 5 times and then hold until the display begins to flash and shows “CL”.
4. Continue to dispense and flush the system until dry argon comes from the spout.

# CIRCUIT DIAGRAM

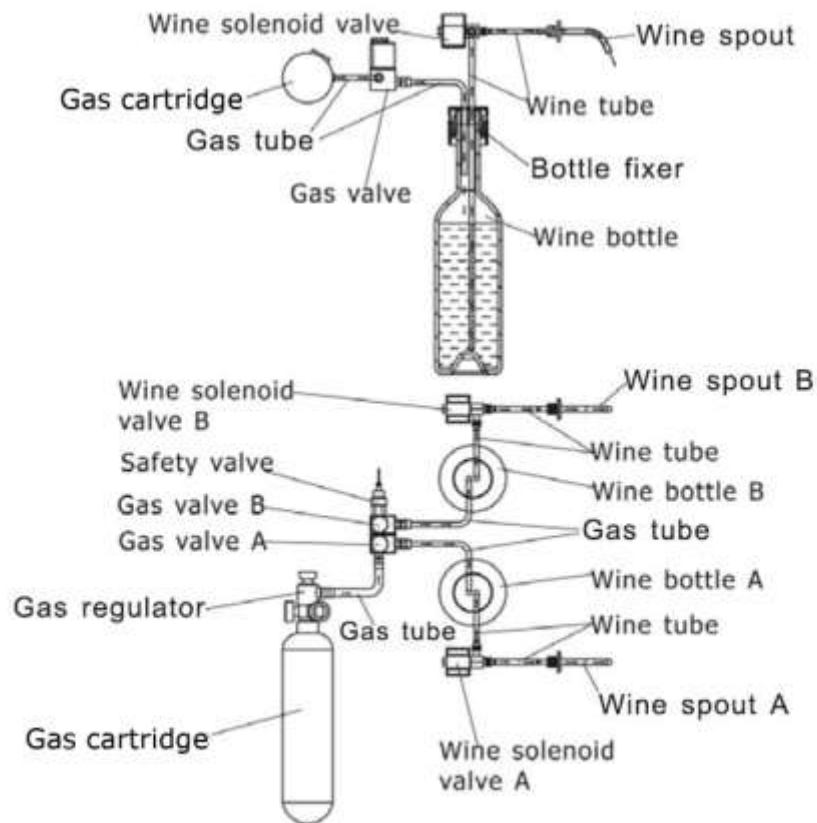
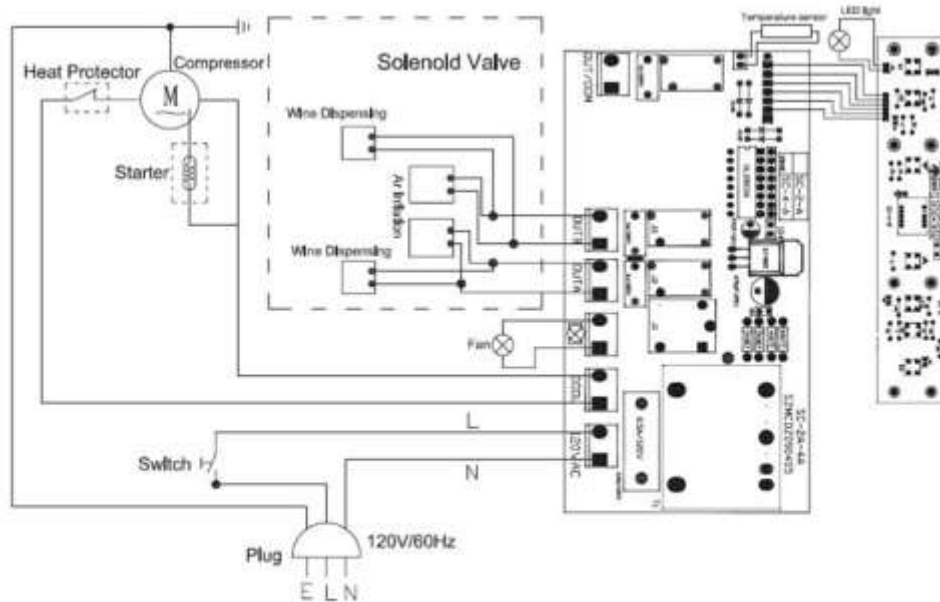

# PROBLEMS WITH YOUR WINE DISPENSER

Most common problems can be solved easily, saving you the cost of a possible service call. Try the suggestions below to solve the problem before contacting Vinotemp at [info@vinotemp.com](mailto:info@vinotemp.com).

## TROUBLESHOOTING

### Dispensing System

Complaint	Possible Causes	Response
<b>One canister only dispensing 1 or 2 bottles, gas leaking/escaping</b>	<ul style="list-style-type: none"> <li>a. Canister gasket unaligned, bad or missing</li> <li>b. Canister not tightened</li> <li>c. Gas tube broken</li> <li>d. Gas tube not tightened at the regulator or valve</li> <li>e. Regulator leak</li> <li>f. Gas valve stuck open</li> <li>g. Bottle not tightened</li> </ul>	<ul style="list-style-type: none"> <li>a. Align, change or install the gasket</li> <li>b. Turn the canister clockwise all the way</li> <li>c. Change the gas tube</li> <li>d. Check for these connections</li> <li>e. Check for gas escaping at the regulator</li> <li>f. If gas continues to escape from the gas tube, check for gas valve and wirings</li> <li>g. Check the plug/fixer</li> </ul>
<b>Unit not dispensing</b>	<ul style="list-style-type: none"> <li>a. Argon/Nitrogen leak</li> <li>b. Defective pressure regulator</li> <li>c. Bottle neck not tightened or defective plug</li> <li>d. Defective gas solenoid valve or incorrect wiring</li> <li>e. Defective wine solenoid valve or incorrect wiring</li> <li>f. Incorrect or loose wirings, defective power board or control board</li> </ul>	<ul style="list-style-type: none"> <li>a. If none of the spouts dispense wine, check for canister pressure gauge or turn the canister slightly counter clockwise to see if any gas escapes (turn clockwise to re-tighten), then check for gas leaking as instructed above</li> <li>b. If none of the spouts dispense wine and the canister has pressurized gas, check the regulator</li> <li>c. Press dispense button to check if gas is escaping from the plug or fixer</li> <li>d. Press the dispense button to see if gas is escaping out of the gas tube</li> <li>e. Switch the questionable valve to a working spout and check to see if problem still exists</li> <li>f. Check all wirings and connections</li> </ul>
<b>Dispensing interrupted or slow</b>	<ul style="list-style-type: none"> <li>a. Argon/Nitrogen low</li> <li>b. Gas tubes kinked or twisted</li> <li>c. Bottle neck not tightened</li> <li>d. Gas solenoid valve restricted</li> <li>e. Wine solenoid valve restricted</li> </ul>	<ul style="list-style-type: none"> <li>a. If all spouts are dispensing wine slowly, check the gas pressure and install a new canister if necessary</li> <li>b. Press dispensing button to see if gas is escaping out of the gas tube slowly</li> <li>c. Check the bottle plug and fixer for escaping gas</li> <li>d. Remove bottle, press dispensing button to see if gas is escaping out of the gas tube</li> <li>e. Switch the to a working spout to check</li> </ul>
<b>Wine spurting or spitting</b>	<ul style="list-style-type: none"> <li>a. Wine tube is restricted</li> <li>b. Bottle is near empty and there is too much gas in the bottle</li> <li>c. Gas pressure is too high</li> <li>d. Wine solenoid valve is dirty</li> </ul>	<ul style="list-style-type: none"> <li>a. Check for any restrictions</li> <li>b. Change the empty wine bottle out for a full one</li> <li>c. Replace the pressure regulator</li> <li>d. Clean solenoid valves</li> </ul>

## Dispensing System

Complaint	Possible Causes	Response
<b>Wine dripping</b>	<ul style="list-style-type: none"> <li>a. Solenoid valve seat leak</li> <li>b. Spout loose</li> </ul>	<ul style="list-style-type: none"> <li>a. Check for debris if constant dripping; use warm water to flush the system</li> <li>b. Push the spout to tighten if there is intermittent dripping</li> </ul>
	<ul style="list-style-type: none"> <li>a. Wine tube leak</li> <li>b. Spout loose</li> <li>c. Empty bottle</li> </ul>	<ul style="list-style-type: none"> <li>a. Check the wine tube</li> <li>b. Push the spout to tighten</li> <li>c. Change the empty bottle out for a full bottle</li> </ul>
<b>Wine divided</b>	<ul style="list-style-type: none"> <li>a. Debris in spout</li> </ul>	<ul style="list-style-type: none"> <li>a. Clean out debris</li> </ul>
<b>Too many bubbles</b>	<ul style="list-style-type: none"> <li>a. Argon/Nitrogen pressure is too high</li> </ul>	<ul style="list-style-type: none"> <li>a. Replace the pressure regulator</li> </ul>

## Cooling system

Complaint	Possible Causes	Response
<b>Unit not running</b>	<ul style="list-style-type: none"> <li>a. Power cord unplugged</li> <li>b. Power switch off</li> <li>c. No power to the outlet</li> <li>d. Incorrect and loose wirings</li> </ul>	<ul style="list-style-type: none"> <li>a. Check the power cord</li> <li>b. Turn the switch on (it will light up when power is on)</li> <li>c. Check for power at the outlet and fuse</li> <li>d. Check the wirings and connections at the power switch and power board</li> </ul>
<b>Unit running high temperature or continually</b>	<ul style="list-style-type: none"> <li>a. Improper door seal</li> <li>b. Ambient temperature is too high</li> <li>c. Improper condenser air flow</li> <li>d. Refrigeration system problems</li> </ul>	<ul style="list-style-type: none"> <li>a. Check the door opening and gasket</li> <li>b. Check the installation location</li> <li>c. Check the fan and clearance</li> <li>d. Call customer service</li> </ul>
<b>Temperature is too high</b>	<ul style="list-style-type: none"> <li>a. Temperature setting is too high</li> <li>b. Displayed temperature is correct but inside temperature is high</li> </ul>	<ul style="list-style-type: none"> <li>a. Lower temperature setting</li> <li>b. Temperature sensor is touching the cold panel</li> </ul>
<b>Temperature is too low</b>	<ul style="list-style-type: none"> <li>a. Temperature sensor is faulty</li> <li>b. Unit is iced</li> <li>c. Power board is faulty</li> <li>d. Display/Control board is faulty</li> </ul>	<ul style="list-style-type: none"> <li>a. Insert the sensor in a cup of iced water to see if it displays 32°F</li> <li>b. Unplug unit to defrost</li> <li>c. Change the power board</li> <li>d. Change the display/control board</li> </ul>
<b>Compressor running but not cooling</b>	<ul style="list-style-type: none"> <li>a. Poor evaporator air flow</li> <li>b. Faulty evaporator fan</li> <li>c. Refrigerant leakage</li> <li>d. Refrigeration system restricted</li> </ul>	<ul style="list-style-type: none"> <li>a. Check for any restrictions</li> <li>b. Check to see if the fan is turning</li> <li>c. Call service technician to check for loss of refrigerant</li> <li>d. Call service technician to check for restrictions</li> </ul>
<b>Noisy operation</b>	<ul style="list-style-type: none"> <li>a. Installation area not firm</li> <li>b. Screws, nuts, and metal parts may be loose</li> <li>c. Fan blade is hitting other parts</li> <li>d. Fan is faulty</li> <li>e. Compressor is faulty</li> </ul>	<ul style="list-style-type: none"> <li>a. Make sure unit is level and on flat, solid surface</li> <li>b. Check to see if the noise is coming from the fan mount, compressor mount or loose tubing</li> <li>c. Check the blade clearance</li> <li>d. Check to see if the fan blade is broken or if the motor is making noise</li> <li>e. Call customer service</li> </ul>



# TERMS OF SALE AND WARRANTY

Vinotemp International ("Seller") and the person or entity that acquires these goods from Seller ("Purchaser") hereby fully agree to the following terms and conditions of the sale: Shipping fees are the responsibility of the Purchaser whether freight prepaid or freight collect. Seller assumes no responsibility for the goods sold to the Purchaser once the goods have left the Seller's premises, including, but not limited to, late delivery by the moving carrier, or for events caused by any difficulty carrier incurs in attempting to fit the goods into the Purchaser's place of business or residence due to the size of the goods or otherwise. Purchaser assumes all responsibility for delivery, payment of freight, access, measurement, installation, hook-up, wiring, moving and storage of the goods. The transportation of all goods is subject to the terms and conditions which the moving carrier imposes on Purchaser including, but not limited to, additional charges imposed per flight of stairs, and/or additional charges resulting from the carrier's inability to safely and/or adequately use the building elevator to lift the goods to an upper floor. Any claim for damages incurred during shipment by the carrier of the goods are insured and handled directly with the carrier and must be noted at time of delivery. Any damages due to manufacture defects will be handled directly with Vinotemp International, subject to the limited warranty.

All sales are final, and unless authorized in writing by the Seller, Purchaser may not return the goods, under any circumstance. If Purchaser refuses to accept the goods, under any circumstance, the Purchaser is liable for the return and cost of freight both ways, and if Seller does take back the goods, there will be a restocking/service fee that is 35% of the purchase price of the goods. (Product must be in original packaging). Built-to-Order products (including Cabinets, Racking, and Accessories) are non-returnable. Purchaser must notify Seller of non-conforming goods within four days of delivery, after which time all goods are deemed accepted. If an order has been placed and production has started, cancellation of your order will be a 15% charge. If Purchaser tenders payment with a check that has insufficient funds (NSF), or stops payment on a check or credit card for any reason, Purchaser agrees to pay for all costs associated with the Seller's collection or litigation of such a claim, including without limitation extra damages, court costs and attorneys' fees. Finance charges begin the date of invoice. Collection fees plus NSF fee of \$50 will be added to your invoice, which you agree to promptly pay. Title to the goods does not pass until payment is received in full by Seller and Seller retains a security interest in the goods until they are paid for in full.

**LIMITED WARRANTY:** Seller warrants that the goods will be free of defects in materials and workmanship as follows: Furniture style (wood) wine cabinets: all cooling unit parts for a period of 5 (five) years; cabinetry and labor (uninstalled) for a period of 12 (twelve) months from date of sale. For the metal cabinet wine units: parts and labor for cooling system and cabinetry for a period of 12 (twelve) months from date of sale. Thermoelectric Units: 90 (ninety) days from the date of sale (including Wine Coolers, Beer Dispensers, Humidor, Portofino Wood Cellars, and Refrigerators). Wine-Mate Split Systems and installed products are parts only for 1 year, no labor. Other Wine-Mate Cooling Systems are 5 years parts, 1 year labor. Wine Accessories and Racking Systems are not warranted. There is no warranty on parts purchased separately. Removal and re-installation of unit is not included in warranted labor. Purchaser's exclusive remedy is limited, at Seller's option; to repair or replace defective part[s] with either new or factory reconditioned part[s]. Purchaser is responsible for shipping the unit pre-paid to designated facility and Seller will pay return shipping charges in the continental United States for items repaired under warranty within 12 (twelve) months from date of sale. Since the natural variation in texture, density, grain, color, tone and shade of wood is unavoidable; Seller does not guarantee the texture, color, tone or shade of the wood: nor does seller guarantee the colorfastness of wood or against peeling, chipping, cracking or scratching. Note: Unfinished wood is subject to warping; all wood surfaces must be sealed before placing cellar into service. Improper placement of the unit will void the warranty. By Vinotemp in writing, any third party repair facility must be pre-approved before providing parts free of charge. This limited warranty does not cover damage due to such things as accident, misuse, abuse, mishandling, neglect, acts of God, fires, earthquakes, floods, high winds, government, war, riot or labor trouble, strikes, lockouts, delay of carrier, unauthorized repair, or any other cause beyond the control of the Seller, whether similar or dissimilar to the foregoing. Seller is not responsible for any damages caused to Purchaser's property resulting from the good. This limited warranty applies only inside the Continental US. (Alaska, Puerto Rico and Hawaii are not warranted.)

For Non-New Units (Scratch & Dent/Refurbished/Floor Models), warranty for compressor units is 90 days from your dated invoice and 30 days for thermoelectric units (parts for function only, not cosmetic defects). These units are refurbished and sold as is; Purchaser assumes risks to the quality and performance of goods and assumes the costs of all necessary service or repair not covered herein.

For Element Grills (via Element Products LLC), grills have a 1 year comprehensive parts warranty on entire product. Three years limited parts warranty covering the stainless burner and a thirty day limited parts warranty on grill accessories. If grill is defective and unused plus all packaging and parts are intact, we will either replace the grill or provide service to repair the grill. Returned product must accompany all original packaging and parts and is subject to our 35% restocking fee (and freight both ways).

With Wine-Mate products, if the customer calls and the product is "defective", you must obtain a letter from your qualified refrigeration technician at the customer's cost, to verify that the unit was installed properly, with proper ventilation and the unit is truly malfunctioning due to manufacture defect.

Purchaser understands and acknowledges that the goods sold here are wine cellars, cigar humidors, and/or other similar units which house wine or cigars. Purchaser assumes all risk of using these units, including risk of spoilage, humidity variations, temperature variations, leaks, fire, water damage, mold, mildew, dryness and similar and any other perils that might occur.

Seller is not responsible for incidental or consequential damages, and there are no warranties, expressed or implied, which extend beyond the Limited Warranty described above. The implied warranties of merchantability and of fitness for a particular purpose are hereby expressly disclaimed. Some states do not allow the exclusion of incidental or consequential damages, or a waiver of the implied warranties of fitness and/or merchantability, so the above limitations may not apply to you. This warranty gives you specific legal rights and you may also have other rights which vary from state to state. Seller disclaims any indemnification for claims of infringement of any intellectual property of protectable nature. In the event of any dispute between Seller and Purchaser arising out of or relating to these terms and conditions or to the goods sold generally, Purchaser must first file a written claim with Seller within ten days of the occurrence giving rise to the claim and wait an additional thirty days for a response before initiating any legal action. The sale and all terms are subject to California law. Any legal proceeding arising out of or relating to these terms and conditions or to the goods sold generally shall be brought solely and exclusively in the County of Los Angeles. In no event may Purchaser initiate any legal proceeding more than six months after the occurrence of the event giving rise to the dispute.

The above terms and conditions are the only ones governing this transaction and Seller makes no oral representations of any kind. These Terms and Conditions can only be modified in writing, signed by both Purchaser and Seller. 05/12

## **SERVICE & IMPORTANT NOTICE**

Upon receipt and inspection of unit, the supply cord must be replaced if it is damaged. Contact our customer service at 1-800-777-8466 or [info@vinotemp.com](mailto:info@vinotemp.com).

The manufacturer has a policy of continuous improvement on its products and reserves the right to change materials and specifications without notice.

### **WARNING:**

**Please do not place the unit within reach of children.  
For adult use only.**

Contact **[info@vinotemp.com](mailto:info@vinotemp.com)** with any questions or visit  
**[www.vinotemp.com](http://www.vinotemp.com)**



17621 S. Susana Road  
Rancho Dominguez, CA 90221  
[www.vinotemp.com](http://www.vinotemp.com)

Vinotemp is a registered trademark of Vinotemp International. All products, features, and services are subject to change without notice. We cannot guarantee the accuracy of the contents of this document. We disclaim liability for errors, omissions, or future changes.

© 2012 Vinotemp International. All rights reserved.



