

# Assembly Instructions

**Caution : You must read this before you proceed**

## TABLE

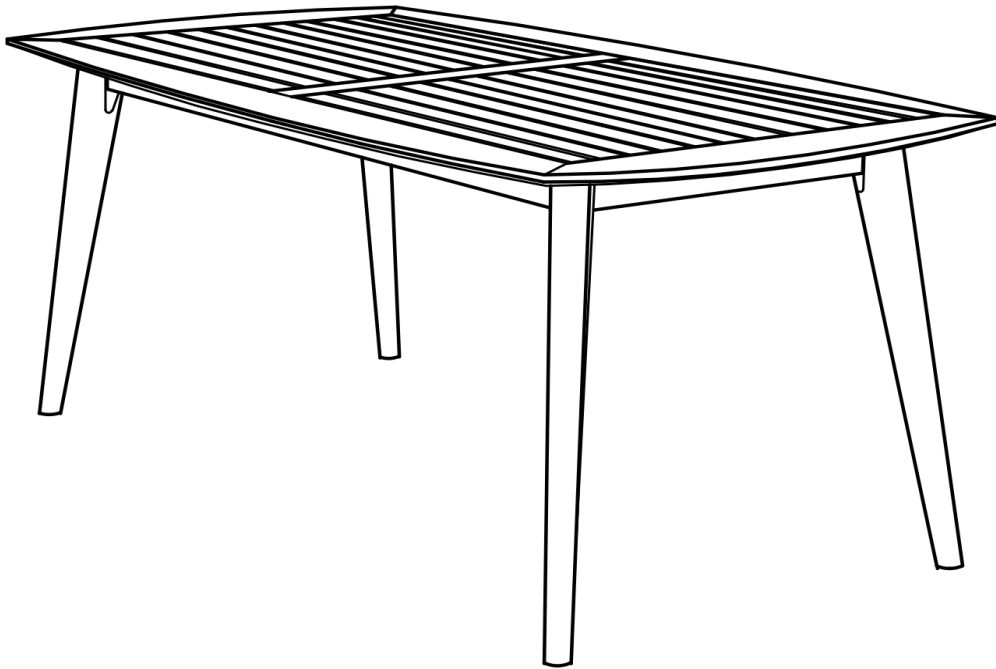



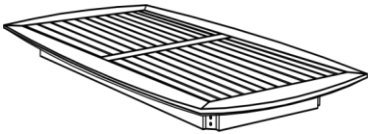

**CAUTION :** This Table is NOT a TOY.  
Keep your child / children at bay in the process of assembly.  
For turning the Table and to prevent damage to the Table, 02 persons may be needed to execute this action.

## Parts List

Label	Picture	Description	QTY
A		Table Top	1

B		Leg	4
---	---	-----	---

## Hardware

Label	Picture	Description	QTY
①		Bolt (M8x55mm)	9
②		Spring Washer (M8.5/10.5x2mm))	9
③		Flat Washer (M8.5/16x2mm)	9
④		Allen Key	1

## Assembly Preparation

Before Beginning Assembly:



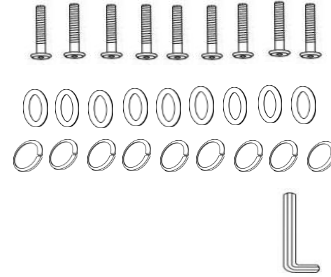
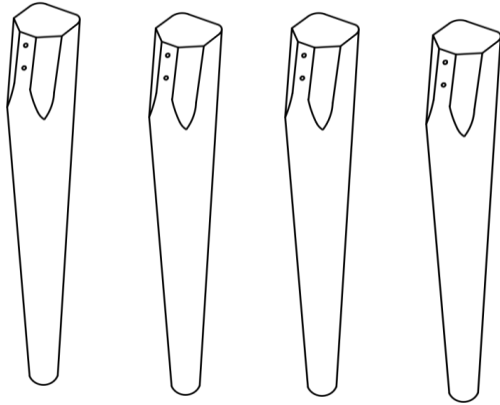
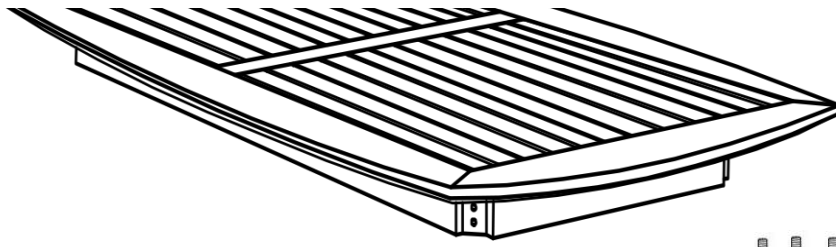

• Read instructions, cover to cover-



• Have 2 adults on hand for assembly-



• Do not assemble on flooring or carpet-



• Assemble on a clean non-marring surface (packing foam)-



• Save all packaging until finished-

## Assembly Steps

## **Overview**

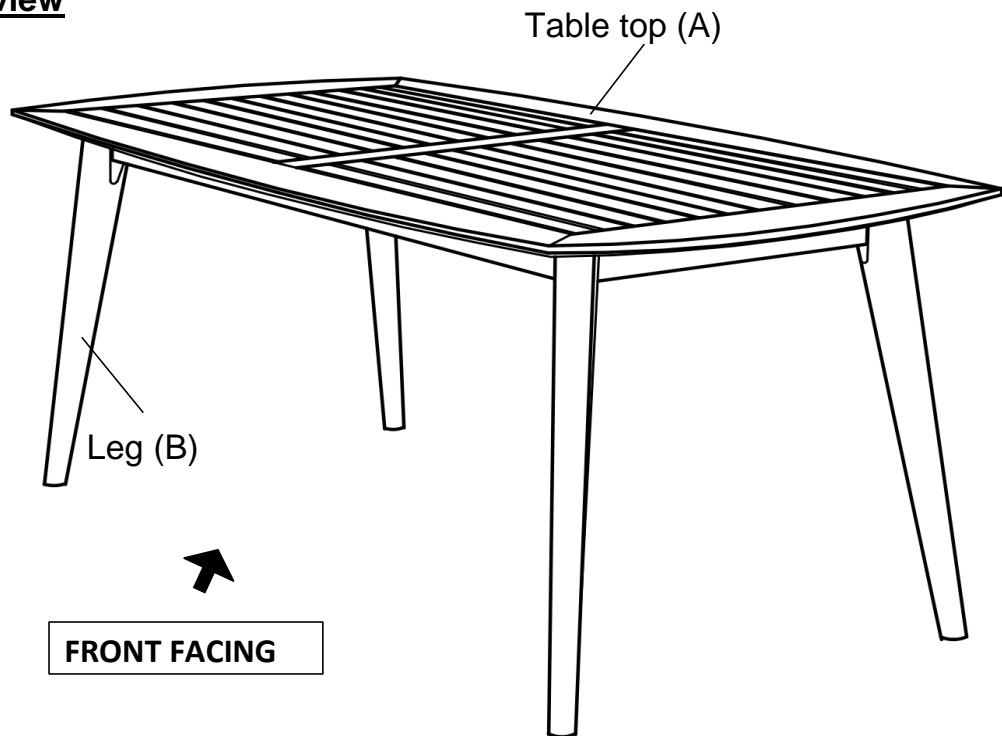

This Table has multiple parts and may require up to 30 minutes to assemble. To give you an overview of the Table parts, the above picture is to help you put the various parts into perspective. Please read through the instructions below to familiarise yourself with the parts and steps

## **Step 1**

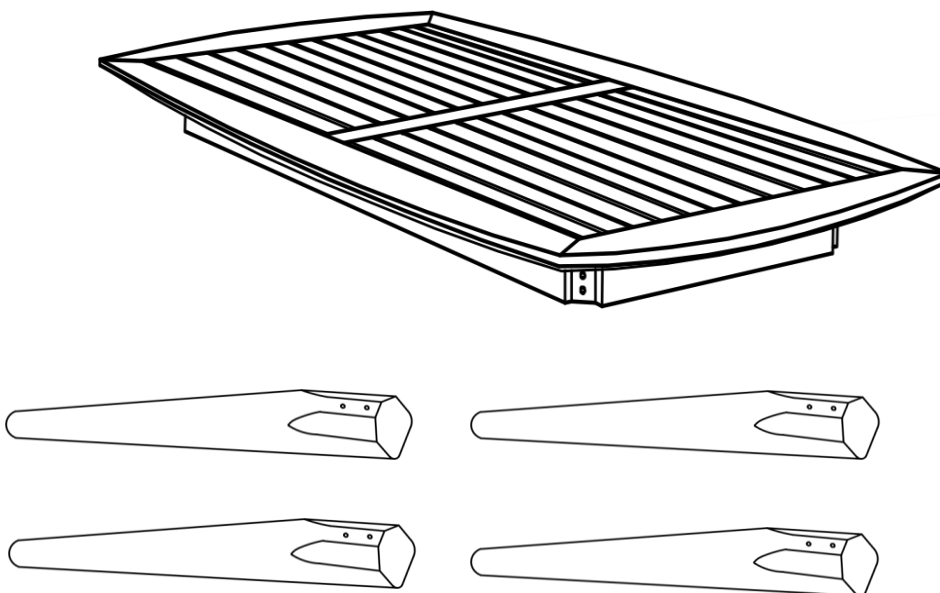

Unpack and place all parts on a clean, non-marring surface.

## Step 2

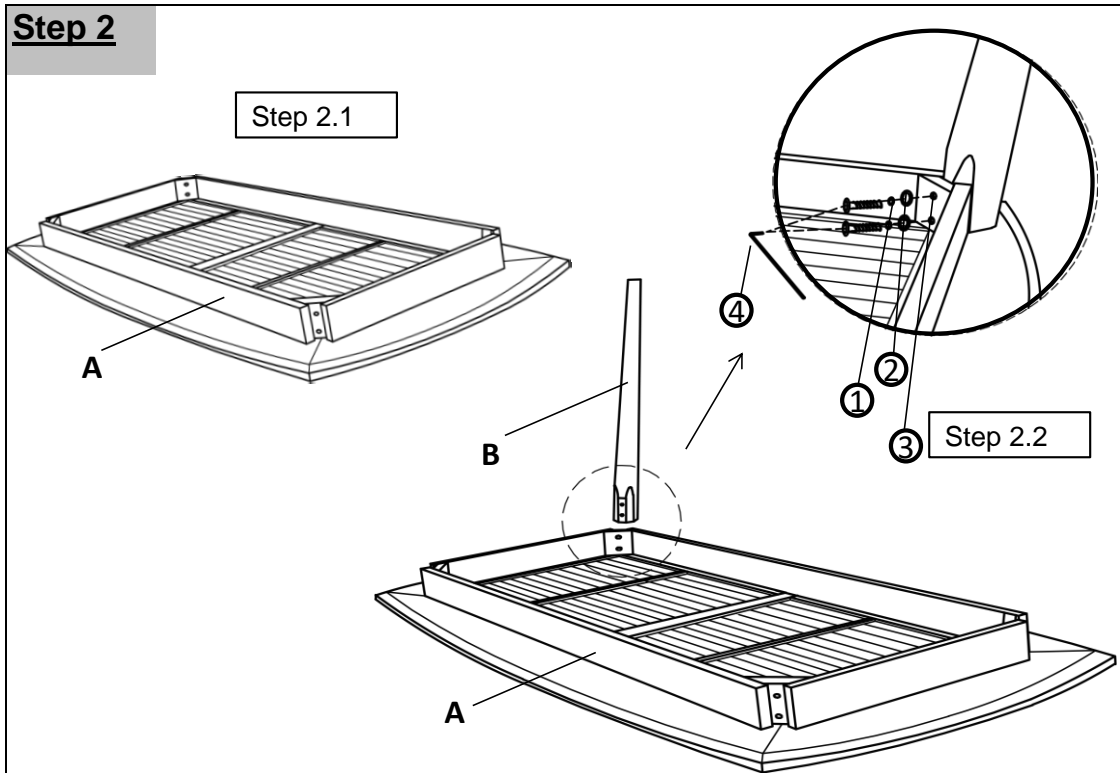

**2.1)** With assistance from your adult partners, turn the Table Top (A) up side down as picture shown

**2.2)** Attach Leg (B) to Table Top (A) by using Bolt (①), Spring Washer (②), Flat Washer (③) and Allen Key (④)

Repeat the same process with the other 3 Legs (B)

**Do not fully tighten the Bolts.**

## Step 3

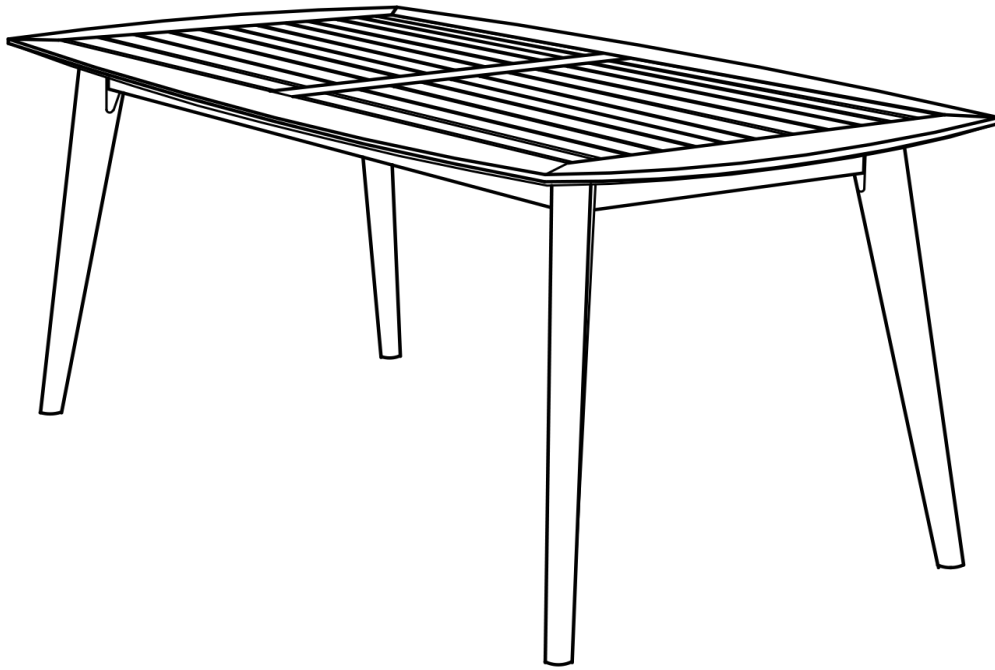

With assistance from your adult partners, turn the Table back to normal flat ground

EXERT pressure, floorwards, onto the Table.

This pressure will help the Legs and Table Top reach alignment at all joints.

Check for wobbles.



















In a sequential manner, gradually tighten all Bolts until evenly secured.

Inspect the Table and make sure all parts are adequately connected.

Your Table is ready for use.

**This Table can only be used on a flat, level surface.**

## Care & Maintenance

-   ● Do not put hot items directly on furniture surface
  -   ● Do not clean furniture with harsh cleansers or polish.
  -   ● To obtain the longest lifespan of your outdoor products, minimizing exposure to direct sunlight is recommended.
  -   ● Children should not climb or jump on the furniture.
  -   ● Do not write on furniture without a padded barrier to protect the surface.
  -   ● To obtain the longest lifespan of your outdoor products, avoid extended and lengthy exposure to rain, snow, and direct sunshine. Whenever possible cover
  -   ● Not for commercial use. For residential use only .
  -   ● Stains may be removed with mild soap solution and damp cloth.
- 
-   ● Dust and pick-up spills using a clean, non-colored, lint-free cloth .

### What is Proposition 65?

Proposition 65 is a California law that requires warning labels on products that may contain one of more than 800-plus chemicals or ingredients that the California Office of Environmental Health Hazard Assessment (OEHHA) has deemed to cause cancer or other reproductive toxicity. Chemicals and elements on this list include wood dust, brass, and other everyday substances, which can be found in very common household items, such as: lamps, tableware, jewelry, crystal glasses, electric cords, beauty products, automobiles, and furniture.

### Why Did I Find a Proposition 65 Warning on My Home Goods Product?

We include Proposition 65 warnings on all of our products because there is always a chance that one of the 800-plus common chemicals and ingredients listed under this law could potentially be on our furniture or packing materials. We risk large fines under this law, if we don't include this warning.

### Should I worry?

We realize you may be worried finding this warning on our products, but we want to reassure you that the hazardous exposure limits for any of these chemicals have never been found on furniture products that we've shipped to our customers. Additionally, this warning label is very common and can be found on almost every piece of furniture sold in the state of California.

### Just How Common Are Proposition 65 Warnings?

Proposition 65 warnings have become so common in California that it is hard to take a trip to a local bank, grocery store, or restaurant without finding at least one warning. In fact, even the Disney Land Resort has a Proposition 65 warning:

