



Compact
Fluorescent Trim **6"Pro-Optic™ Lensed**
2 Horizontal Quad Tube Lamp
Non-IC

Recessed

Type _____

-68

P8035

Finish

Catalog No. Prismatic

P8035 -68

Dimensions (Inches)

A **B** **C**
7 5-3/4 5-3/4

Maximum Ceiling Thickness: 1-1/4"

Ceiling Opening: 6-1/4" (See guide for retrofit)

P163H, P168H, P16H

HOUSING COMPATIBILITY GUIDE

ORDERING GUIDELINES	6 INCH OPENING RANGE	
	MIN	MAX
REQUIRES SD HOUSING OPTION	5-15/16	6-1/8
ALL STANDARD HOUSINGS	6-1/8	6-1/2
ONLY P8030 SERIES TRIMS AVAILABLE: 'WF' OPTION	6-1/2	6-7/8

Dimensions shown are for the diameter of the frame flange at it's narrowest point

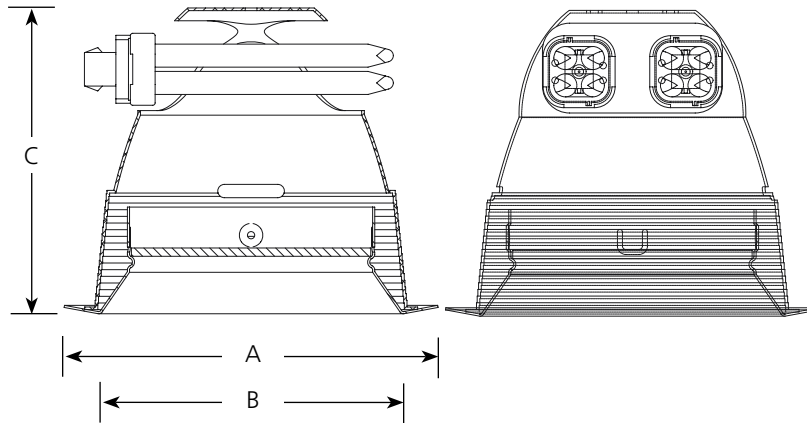
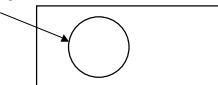

Lamp Wattage

Housings

New Construction	Retrofit	IC	Non-IC
P63-EB	P163H-EB	N/A	2-13w Quad Tube
P68-EB	P168H-EB	N/A	2-18w Quad Tube
P66-EB	P166H-EB	N/A	2-26w Quad Tube
P66-DM	P166H-DM	N/A	2-26w Quad tube

Specifications:

Trim

- White painted regressed metal trim with integral flange retains the lenses
- Attaches to reflector with two scissor springs

Reflector

- All aluminum construction
- One piece construction with integral flange
- No light leaks around trim flange
- Socket cup mounts to reflector for optimum performance and consistent lamp position

- Reflector retention accomplished by spring clips located in aperture of housing

- White painted finish

Lens

- Prismatic (-68) glass lense
- Protects lamps from below ceiling

Labeling

- cCSAus wet location listed
- Non-IC rated

Progress Lighting
701 Millennium Blvd.
Greenville, South Carolina
29607



P63-EB/P8035-68

6" DOWNLIGHT 1100 Alloy Aluminum White Paint Conoid Splay w/

Report No. 2804

No. Lamps: 2 Type Lamp: 2 - CFL, QUAD TUBE SLVAN Total Lumens: 1800

Fixture Efficiency: 21.0%

S/MH Ratio: 0.9 (0°) 1.1 (90°)

Single Fixture Data

Ceiling Ht.(Ft.)	10% Values		Zero Degrees Ft.-C	50% Values	
	Beam Angle - 85°			Beam Angle - 54°	
	Ft.-C	Beam Dia.		Ft.-C	Beam Dia.
8	0.9	10	9.2	4.6	6
10	0.5	14	4.9	2.5	8
12	0.3	18	3.1	1.5	10
14	0.2	21	2.1	1.0	12
16	0.2	25	1.5	0.8	14

Ft.-C (Footcandles) are initial and measured 2'-6" from floor

Quick Calculator Charts

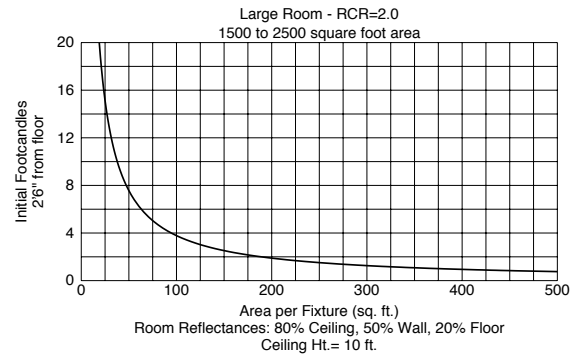
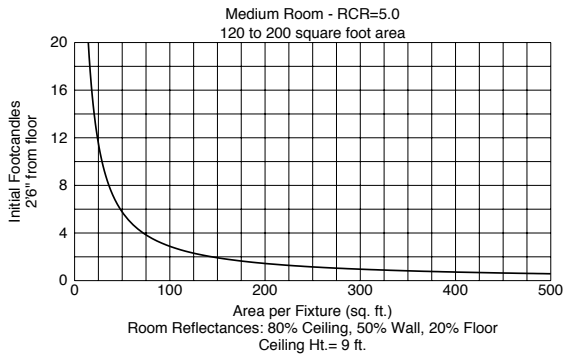

DISTRIBUTION CURVE

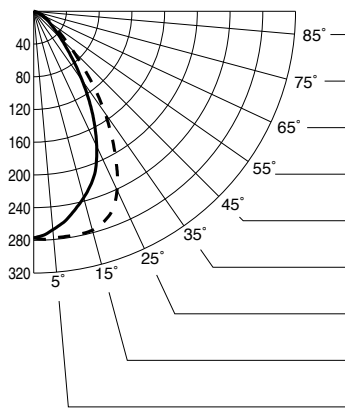

INTENSITY DATA

DEGREES	CANDELA	
	AT 0'	AT 90'
90	0	0
85	0	0
80	1	1
75	4	4
70	7	8
65	11	12
60	15	18
55	23	27
50	32	43
45	47	67
40	70	105
35	103	152
30	143	198
25	182	241
20	215	267
15	236	277
10	254	278
5	268	278
0	277	277

ZONAL CAVITY COEFFICIENTS OF UTILIZATION

Effective Floor Cavity Reflectance 0.20

RC	Effective Floor Cavity Reflectance 0.20																						
	80				70				50				30				10				0		
RW	70	50	30	10	70	50	30	10	50	30	10	50	30	10	50	30	10	50	30	10	0		
0	25	25	25	25	24	24	24	24	23	23	23	22	22	22	21	21	21	21	21	21	21		
1	24	23	22	22	23	22	22	21	22	21	21	21	20	20	20	20	19	19	19	19	19		
2	22	21	20	19	22	21	20	19	20	19	18	19	19	18	19	18	18	18	18	18	17		
3	21	19	18	17	20	19	18	17	18	17	16	18	17	16	17	17	16	16	16	16	16		
4	19	18	16	15	19	17	16	15	17	16	15	16	15	15	16	15	14	14	14	14	14		
5	18	16	15	14	18	16	15	14	16	14	13	15	14	13	15	14	13	13	13	13	13		
6	17	15	13	12	17	15	13	12	14	13	12	14	13	12	14	13	12	12	12	12	12		
7	16	14	12	11	16	14	12	11	13	12	11	13	12	11	13	12	11	11	11	11	11		
8	15	13	11	10	15	13	11	10	13	11	10	12	11	10	12	11	10	10	10	10	10		
9	14	12	11	10	14	12	11	10	12	10	10	11	10	10	11	10	10	9	9	9	9		
10	14	11	10	9	13	11	10	9	11	10	9	11	10	9	11	10	9	9	9	9	9		



P66-EB/P8035-68

6" RECESSED/DOWNLIGHT

Report No. 312-PRO

No. Lamps: 2 Type Lamp: 2-F26DBX/SPX27/4P-GE Total Lumens: 3420

Fixture Efficiency: 24.7%

S/MH Ratio: 1.0 (0°) 1.0 (90°)

Single Fixture Data

Ceiling Ht.(Ft.)	10% Values		Zero Degrees Ft.-C	50% Values	
	Beam Angle - 96°			Beam Angle - 53°	
	Ft.-C	Beam Dia.		Ft.-C	Beam Dia.
8	1.6	12	16.3	8.1	5
10	0.9	17	8.8	4.4	7
12	0.5	21	5.5	2.7	9
14	0.4	26	3.7	1.9	11
16	0.3	30	2.7	1.4	13

Ft.-C (Footcandles) are initial and measured 2'-6" from floor

Quick Calculator Charts

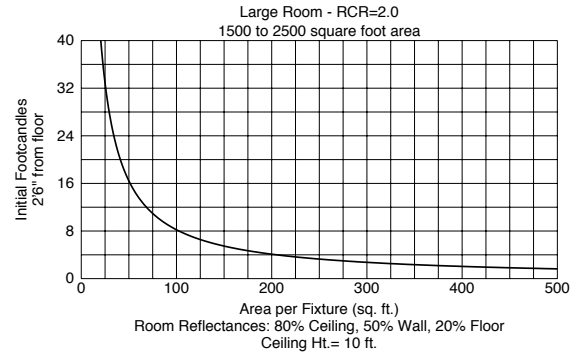
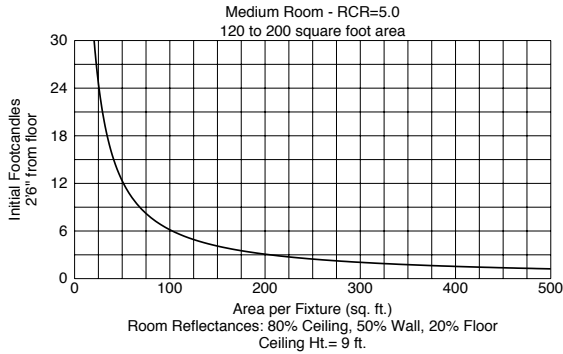

DISTRIBUTION CURVE

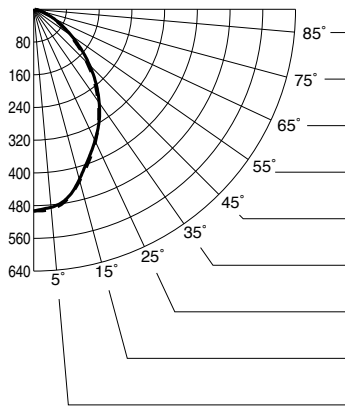

INTENSITY DATA

DEGREES	CANDELA	
	AT 0°	AT 90°
90	1	1
85	4	4
80	9	9
75	21	20
70	34	33
65	54	51
60	81	76
55	113	107
50	151	143
45	193	184
40	237	230
35	279	274
30	319	317
25	354	357
20	390	395
15	431	434
10	469	472
5	486	491
0	493	493

ZONAL CAVITY COEFFICIENTS OF UTILIZATION

Effective Floor Cavity Reflectance 0.20

RC	Effective Floor Cavity Reflectance 0.20																	
	80			70			50			30			10			0		
RW	70	50	30	10	70	50	30	10	50	30	10	50	30	10	50	30	10	0
0	30	30	30	30	29	29	29	29	28	28	28	26	26	26	25	25	25	25
1	28	27	26	25	27	26	25	25	25	24	24	24	24	23	23	23	22	22
2	25	24	22	21	25	23	22	21	23	21	21	22	21	20	21	20	20	19
3	24	21	20	18	23	21	19	18	20	19	18	20	19	18	19	18	17	17
4	22	19	17	16	21	19	17	16	18	17	16	18	17	16	17	16	15	15
5	20	18	16	14	20	17	15	14	17	15	14	16	15	14	16	15	14	13
6	19	16	14	13	19	16	14	13	15	14	13	15	14	12	15	13	12	12
7	18	15	13	11	17	15	13	11	14	12	11	14	12	11	13	12	11	11
8	17	14	12	10	16	13	12	10	13	11	10	13	11	10	13	11	10	10
9	16	13	11	9	15	12	11	9	12	11	9	12	10	9	12	10	9	9
10	15	12	10	9	14	12	10	9	11	10	9	11	10	9	11	10	9	8



FireBox®
Compact
Fluorescent Trim

**6" Pro-Optic FireBox® Regressed Prismatic
2 Horizontal Lamps**

Recessed

Non-IC

Type _____

-68FB

P8035

Finish

Catalog No.	Finish
P8035	-68FB

Dimensions (Inches)

A	B	C
7-3/4	6-3/8	5-1/2

Maximum Ceiling Thickness: 1-1/8"

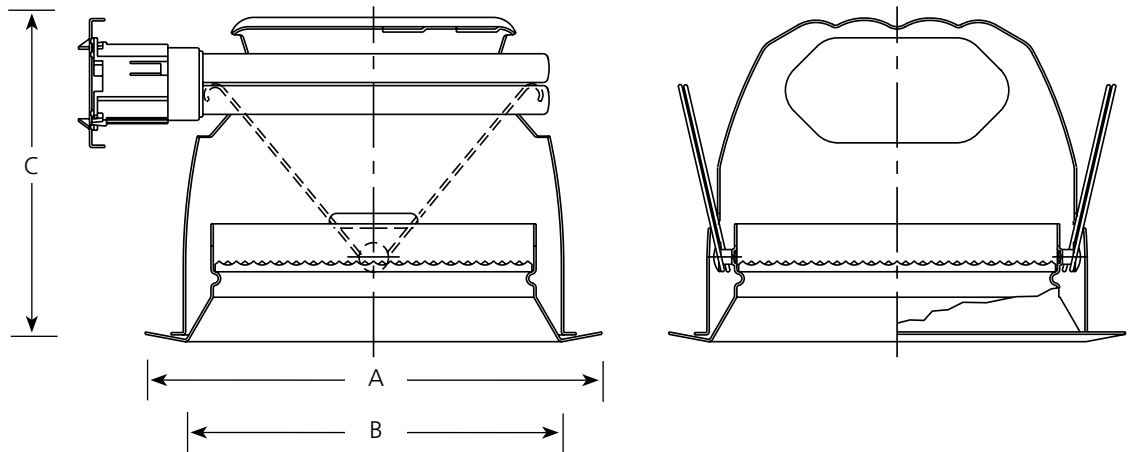

*Lamps shown are 13w quad tube compact fluorescent

Lamp Wattage

Housing	IC	Non-IC
P63-EBFB	N/A	2 13w Quad 4-Pin
P68-EBFB	N/A	2 18w Quad 4-Pin
P66-EBFB	N/A	2 26w Quad 4-Pin

Specifications:

Flange

- White painted metal flange

Trim

- All aluminum construction
- One piece upper conoid reflector with white finish
- No light leaks around trim flange
- Socket box mounts to trim for optimum performance and consistent lamp position
- Trim retention accomplished by 3 spring clips located in aperture of housing

Lens

- A 12 acrylic lens in regressed trim frame with scissor springs for lamp access: 5-3/8" dia. x 3/16" ht.
- Protects lamps from below ceiling

Labeling

- UL-CUL wet location listed
- Non-IC rated

Progress Lighting
701 Millennium Blvd.
Greenville, South Carolina
29607

www.progresslighting.com
Patent# 6,254,257



P68-EBFB

P68-EBFB WITH P8035-68FB

Report No. 99052

No. Lamps: 2 Type Lamp: 18W CF QUAD - GE Total Lumens: 2500

Fixture Efficiency: 19.6%

S/MH Ratio: 1.1 (0°) 1.1 (90°)

Single Fixture Data

Ceiling Ht.(Ft.)	10% Values		Zero Degrees	50% Values	
	Beam Angle - 100°			Beam Angle - 59°	
	Ft.-C	Beam Dia.		Ft.-C	Beam Dia.
8	0.8	13	8.4	4.2	6
10	0.5	18	4.5	2.3	8
12	0.3	23	2.8	1.4	11
14	0.2	27	1.9	1.0	13
16	0.1	32	1.4	0.7	15

Ft.-C (Footcandles) are initial and measured 2'-6" from floor

Quick Calculator Charts

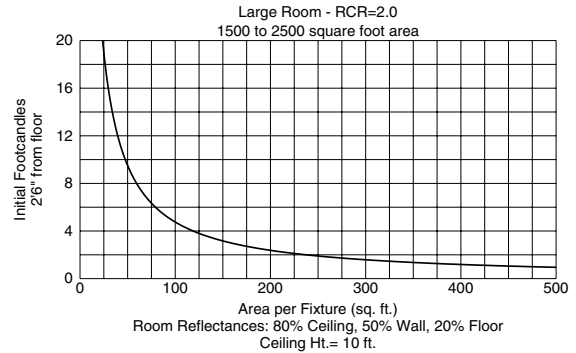
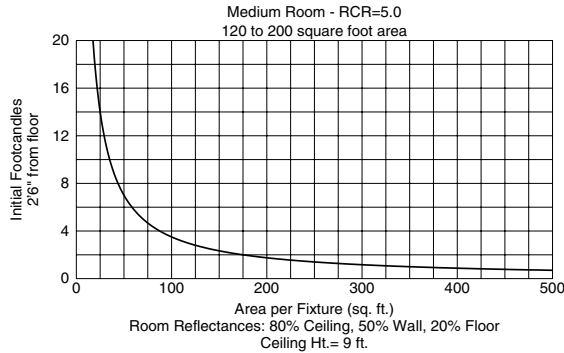

DISTRIBUTION CURVE

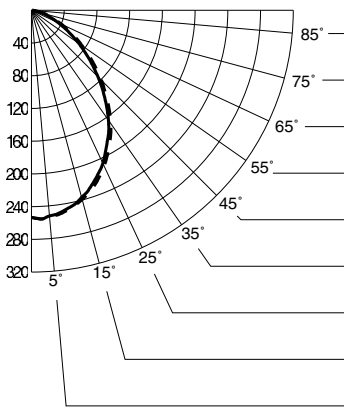

INTENSITY DATA

DEGREES	CANDELA	
	AT 0°	AT 90°
90	0	0
85	2	4
80	6	9
75	15	18
70	24	28
65	36	41
60	52	57
55	71	76
50	92	98
45	115	121
40	139	145
35	164	169
30	185	190
25	206	210
20	223	227
15	237	240
10	247	249
5	252	253
0	253	253

ZONAL CAVITY COEFFICIENTS OF UTILIZATION

RC	Effective Floor Cavity Reflectance 0.20																					
	80				70				50				30				10				0	
	RW	70	50	30	10	70	50	30	10	50	30	10	50	30	10	50	30	10	50	30	10	0
0	23	23	23	23	23	23	23	23	22	22	22	21	21	21	20	20	20	20	20	20	20	20
1	22	21	20	20	21	20	20	19	20	19	19	19	19	18	18	18	18	17	17	17	17	17
2	20	19	18	17	20	18	17	16	18	17	16	17	16	16	16	16	15	15	15	15	15	15
3	19	17	15	14	18	16	15	14	16	15	14	15	14	14	15	14	13	13	13	13	13	13
4	17	15	14	12	17	15	13	12	14	13	12	14	13	12	13	13	12	11	11	11	11	11
5	16	14	12	11	15	13	12	11	13	12	11	13	12	11	12	11	11	10	10	10	10	10
6	15	12	11	10	14	12	11	10	12	11	10	12	10	10	11	10	9	9	9	9	9	9
7	14	11	10	9	13	11	10	9	11	10	9	11	9	9	10	9	9	8	8	8	8	8
8	13	10	9	8	13	10	9	8	10	9	8	10	9	8	10	9	8	7	7	7	7	7
9	12	10	8	7	12	10	8	7	9	8	7	9	8	7	9	8	7	6	6	6	6	6
10	11	9	8	7	11	9	7	7	9	7	7	9	7	6	8	7	6	6	6	6	6	6



P66-EBFB

P66-EBFB WITH P8035-68FB

Report No. 99046

No. Lamps: 2 Type Lamp: 26W CF QUAD - GE Total Lumens: 3600

Fixture Efficiency: 17.6%

S/MH Ratio: 1.1 (0°) 1.1 (90°)

Single Fixture Data

Ceiling Ht.(Ft.)	10% Values		Zero Degrees	50% Values	
	Beam Angle - 99°			Beam Angle - 58°	
	Ft.-C	Beam Dia.		Ft.-C	Beam Dia.
8	1.1	13	11.0	5.5	6
10	0.6	17	5.9	3.0	8
12	0.4	22	3.7	1.9	11
14	0.3	27	2.5	1.3	13
16	0.2	31	1.8	0.9	15

Ft.-C (Footcandles) are initial and measured 2'-6" from floor

Quick Calculator Charts

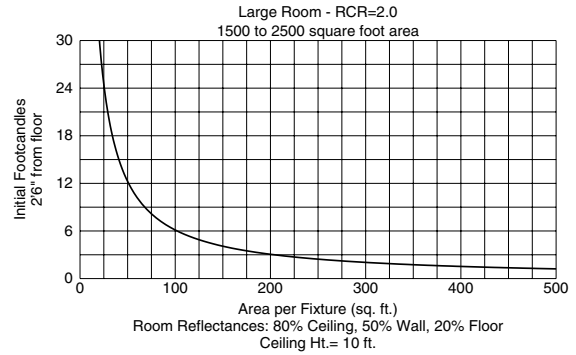
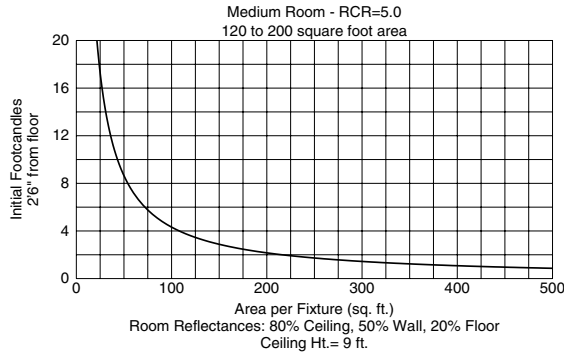

DISTRIBUTION CURVE

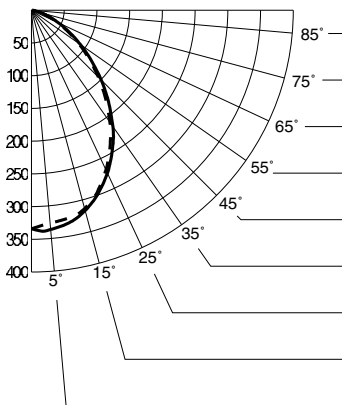

INTENSITY DATA

DEGREES	CANDELA	
	AT 0°	AT 90°
90	0	0
85	3	3
80	6	6
75	17	15
70	29	28
65	46	43
60	66	64
55	91	87
50	119	114
45	151	145
40	183	176
35	217	209
30	247	240
25	275	269
20	298	295
15	317	314
10	330	323
5	336	327
0	334	334

ZONAL CAVITY COEFFICIENTS OF UTILIZATION

RC	Effective Floor Cavity Reflectance 0.20																							
	80				70				50				30				10				0			
	RW	70	50	30	10	70	50	30	10	50	30	10	50	30	10	50	30	10	50	30	10	0		
0	21	21	21	21	20	20	20	20	19	19	19	19	19	19	18	18	18	18	18	18	18			
1	19	19	18	18	19	18	18	17	18	17	17	17	17	16	16	16	16	15	15	15	15			
2	18	17	16	15	18	16	15	15	16	15	14	15	15	14	15	14	14	13	13	13	13			
3	17	15	14	13	16	15	14	13	14	13	12	14	13	12	13	13	12	12	12	12	12			
4	15	14	12	11	15	13	12	11	13	12	11	12	12	11	12	11	11	10	10	10	10			
5	14	12	11	10	14	12	11	10	12	11	10	11	10	10	11	10	9	9	9	9	9			
6	13	11	10	9	13	11	10	9	11	10	9	10	9	9	10	9	8	8	8	8	8			
7	12	10	9	8	12	10	9	8	10	9	8	10	9	8	9	8	8	7	7	7	7			
8	12	9	8	7	11	9	8	7	9	8	7	9	8	7	9	8	7	7	7	7	7			
9	11	9	7	6	11	9	7	6	8	7	6	8	7	6	8	7	6	6	6	6	6			
10	10	8	7	6	10	8	7	6	8	7	6	8	7	6	7	7	6	6	6	6	6			