



Home & Garden Spas

Owner's Manual for

Two Pump Spas



Service and Technical Support

For technical assistance or warranty service requests, please call a technical support representative at 844-894-6659. Factory trained technical support representatives are available Monday - Friday from 8:30 am to 5 pm EST. Because the components vary by model, providing photographs expedites resolution and increases accuracy. You should be prepared to email the pictures to the technical support representative while you are on the phone.

If you are calling to request cabinet pieces, please take pictures of the damaged area before you call.

If you are calling for technical assistance, please take pictures of topside controls, the GFCI and your main breaker before you call.

You will be asked to provide the following information when you call. Most of this information can be found your purchase receipt.

Spa Model _____

Spa Serial Number _____ Date of Purchase _____

Dealer Name _____

Approximate Date of Spa Installation _____

Read and Follow All Instructions !



Table Of Contents

Service and Support	2
Understanding Symbols	3
Warnings and Safety Information	4
Site Preparation and Installation Recommendations	9
Electrical Requirements and Recommendations	13
Filling your Spa with Water	18
Operating Instructions for Topside Controls	
Using the Topside Controls	21
Topside Control Messages	28
Getting to Know Your Spa	
Electronic components	30
Plumbing components	31
Maintaining Water Quality	
Basic fundamentals of water chemistry	34
How to add chemicals to the water	38
Troubleshooting water chemistry	42
General Care and Maintenance	44
Troubleshooting Guide	47
Manufacturer's Warranty	50

Important Symbols

Symbols are used throughout this manual to help alert you to particularly important information. Pay close attention when you see the following symbols:



Danger! Proceed with extreme caution to prevent the risk of severe injury and/or death



Warning - Proceed with care to prevent avoidable accidents and potential risks.



Step by step instructions for important procedures.



Keys to Success - Details, tips and tricks from industry professionals.

Read and Follow All Instructions !



For technical support and assistance, call 844-894-6659

Safety Information



DANGER!
Risk of Electrocution



ALL ELECTRICAL CONNECTIONS MUST BE MADE BY A LICENSED ELECTRICIAN.

Ground Fault Circuit Interrupter installed in compliance with section 680-42 of the National Electrical Code, ANSI/NFPA 70-1993 is required for user safety and equipment protection. You should inspect the Ground Fault Circuit Interrupter before each use to be sure it is functioning properly, in good condition and that the wiring is connected properly. To ensure the spa functions properly and that your warranty is not compromised by improper installation, a licensed electrician must install all electrical components and make electrical connections. Connect only to a grounded source a minimum of five feet (1.5m) from any metal surface. Solid copper bonding conductors must be in compliance with local ordinances and located between the ground terminal inside the spa control box and any metal equipment, including pipes, electrical equipment enclosures, and conduit within five feet (1.5m) of the spa. To prevent death or serious injury from electrocution that can occur if an appliance falls into the spa, do not permit any electrical appliances, such as lights, telephones, MP3 players, radios or televisions to be within five feet (1.5m) of the spa unless they were installed by the manufacturer.

- Disconnect the spa from the power supply before draining and servicing components.
- Test the Ground Fault Interrupter(s) before each use.
- Replace damaged wires and cords immediately to reduce the risk of electric shock. Failure to do so may result in death or serious permanent injury by electrocution.
- Do not bury wire without electrical conduit approved for underground use.
- Equipment compartment doors must be properly installed before using the spa.
- Replace components with components identical to components supplied by the manufacturer.
- Do not operate the audio or television equipment while you are inside the spa.
- Unless it was installed and provided by the manufacturer, audio and video equipment and other electrical appliances should not be used within 5 feet (1.5m) of the spa. Do not connect auxiliary components (i.e. headphones) to the system.
- You should only perform service to parts inside the spa control box with assistance from our technical support team.



Safety Information



DANGER!

Risk of Children Drowning.



Extreme caution must be used to prevent unauthorized access by children. To avoid accidents, ensure that children cannot use the spa unless they are supervised at all times. To reduce risk of injury, do not allow children to use this product unless they are closely supervised at all times. To reduce the risk of injury, lower water temperature when spa is used by children. Lower water temperatures are recommended since children are especially sensitive to hot water.

- Make sure child resistant locks on the spa cover are engaged after use. Spa covers sold with a Dr. Wellness Spa meets the ATSM F1346-91 Standard for Safety Covers. However, use of the cover, locking clips or actual locks will not prevent access to the spa, so children should not be left unattended.
- Children are especially sensitive to hot water. Lower water temperatures are recommended for children. Test the water temperature with a thermometer or your hands to be sure it's comfortable before allowing children to enter the spa.
- Remind children that wet surfaces are slippery. Make sure that children are careful when entering and exiting the spa.
- Check with local authorities regarding fencing requirements for spas in your area.
- Keep children and pets off the spa cover. Most spa covers have a maximum weight load of 20 lbs. They will not support the weight of people or pets. Sitting on the cover may cause the foam inserts to break.
- Children should always be in the company of a responsible adult and should not have unattended access to the spa.



DANGER!

Risk of Drowning or Serious Injury from Suction Fittings, Filters and Skimmers



Keep clothing, hair or hanging jewelry away from suction fittings, rotating jets or other moving components. Never operate the spa if the filter(s), filter lid(s), skimmer(s), or skimmer assembly(s) are missing. Do not remove basket(s) or filter(s) while spa is running. The suction fittings have a specific water flow rating. Replacement suction fitting must be compatible with the flow rate marked on the original suction fitting. Never operate the spa if the suction fittings are broken or missing. Please contact technical support at 844-894-6659 for service and replacements or repair.



Safety Information



DANGER!

Risk of Hyperthermia

Prolonged immersion in hot water can result in HYPERTHERMIA, a dangerous condition occurring when the internal temperature of the body reaches a level above normal (98.6°F). The symptoms of hyperthermia include unawareness of impending hazard, failure to perceive heat, failure to recognize the need to exit the spa, physical inability to exit the spa, fetal damage in pregnant women, and unconsciousness resulting in a danger of drowning. The use of alcohol, drugs or medication can greatly increase the risk of fatal hyperthermia.

- The Consumer Products Safety Commission has stated that the water in the spa should never exceed 104°F (40°C). Water temperatures between 100°F (38°C) and 104°F (40°C) are considered safe for a healthy adult.
- Lower water temperatures are recommended for extended use (exceeding 10 minutes) and for young children. Extended use at higher temperatures can cause hyperthermia.
- Pregnant or possibly pregnant women should consult a physician before using a spa.
- Pregnant women should reduce the water temperatures to no more than 100°F (38°C). Failure to do so may result in permanent injury to your baby.



WARNING!

Adverse Affects with Certain Medical Conditions

You should consult your physician if you are pregnant or possibly pregnant, obese, have a medical history of heart disease, low or high blood pressure, circulatory problems, infectious diseases, immune deficiencies, infections skin irritations, or diabetes.



WARNING!

Increased Side Effects of Medication

The use of drugs, alcohol, or medication before or during spa use may lead to unconsciousness with the possibility of drowning. Anyone using medication should consult a physician before using a spa; some medication may cause a user to become drowsy, while other medication may affect the heart rate, blood pressure or circulation. Anyone taking medications which induce drowsiness, such as tranquilizers, antihistamines or anticoagulants should not use a spa.



Safety Information



WARNING!

Maintaining Well Balanced Water Chemistry



To reduce the possibility of contracting a waterborne illness, always maintain water chemistry within the parameters in this manual. Keep the water clean and sanitized with correct chemical balance to help maintain safe water and prevent possible damage to spa components and bathers. If other bathers are negatively affected, discontinue use and consult a physician. The recommended levels for your Dr. Wellness Spa are:

Free Available Chlorine (FAC):	3.0 to 4.0 ppm
Free Available Bromine (FAB):	2.0 to 4.0 ppm
Total Alkalinity	80 to 120 ppm
Water pH	7.2 to 7.6
Calcium Hardness	150 to 250 ppm

- Always shower before and after using a spa.
- Refer to Water Chemistry and Maintenance section for further information and complete instructions about water and spa care.
- When adding chemicals, turn the primary pump on for at least ten minutes after adding any spa chemicals into the filter compartment.
- Replace or clean the filter cartridge regularly to remove debris and mineral buildup which may affect the performance of jets, limit the water flow, or trip the high limit thermostat which will automatically turn off the entire spa to prevent further damage to the spa.
- Stay out of the spa if you have open wounds or an infections disease.



Safety Information

IMPORTANT SAFETY REMINDERS

- Wet surfaces can be slippery. To reduce the risk of injury, exercise care when entering and exiting the spa. Give children instructions about how to safely enter and exit the spa.
- Remove all jewelry and put long hair in a bathing cap or hair tie before you enter the spa.
- Measure the water temperature with an accurate thermometer before entering the spa to verify the topside control displays the correct temperature. The tolerance of regulating devices may vary as much as +/- 5°F (2°C).
- Test the water with your hand to be sure it's comfortable before entering the spa.
- Remove debris from filter baskets and suction drains.
- Do not allow glass, sharp or other breakable objects in or near the spa area.
- Do not use alcohol or drugs before or during spa use. Stay well hydrated and drink plenty of water.
- If you are going to be in the spa for more than 10 minutes, you should reduce the temperature of the spa to 100°F (40°C) or lower.
- Do not use the spa immediately after strenuous exercise.
- Never use your spa when you are alone.
- Stay out of the spa if you have open wounds or an infectious disease.
- Consult a physician if you are pregnant, have a medical condition or are taking medication before using a spa.
- Never leave the spa unattended if the cover is not locked securely in place whether it is empty or filled with water. Exposure to sunlight, rain, snow and high temperatures may cause permanent damage to the spa.
- Leave the cover partially open for 20 minutes when adding chemicals to allow chemical vapor to escape.
- Do not leave the spa unattended when the cover is off.
- Brush heavy snow loads off the cover with a soft brush. Spa covers are not designed to hold weight loads of more than 20 pounds.
- Reinforce your cover with wind straps during periods of high wind. The tie downs sewn on the cover will not hold your cover in place if wind speeds are excessive.
- Use only approved and recommended accessories, chemicals and cleaners.
- Never leave the spa unattended when the cover is off.
- Never allow children or pets to sit or stand on the spa cover.
- Always lift or carry the cover by using the handles, not the skirt or tie downs.



Site Preparation, Delivery & Installation Recommendations

CHOOSING A LOCATION

Choosing the right location for your spa requires careful consideration of esthetics and convenience in addition to the care and maintenance that is required over the life of your spa. Planning and preparation are critical, but following a few basic guidelines will ensure a lifetime of enjoyment



SITE SELECTION CONSIDERATIONS



- Make sure the installation meets your local codes, covenants and restrictions. Many communities require that spa installations be done with the same security precautions, like fences with locking gates, as swimming pools.
- Make sure the location is free of obstacles that may interfere with delivery and installation. The overall dimensions are an important consideration when planning for delivery & installation. A clear pathway from the curb to the installation site makes delivery a breeze. The pathway should be free of obstruction from things like walls, fences, tree limbs, heat pumps, and power lines. Check to be sure gate openings are wide enough for the spa to pass through without damaging the spa.
- Normal use of your spa will mean lots of splashing. Choose a location that allows water to easily drain away from the base of the spa rather than pooling around the spa. Close proximity to a water hose will allow you to easily top off the spa after each use.
- Consider the proximity to the doors of the house, especially in cold weather. Be sure there is a pathway to the spa that can be easily maintained in inclement weather.
- Keep your spa away from landscaping sprinklers, roof overhangs and gutters. Adequate drainage that prevents standing water near the foundation of the spa is critical.
- But you should also consider the negative effects of wind, exposure to the sun and the location of trees to minimize the effects of falling debris, excessive sunlight and shade.
- Choose a location that allows easy access for maintenance and repairs. You should leave 24" of clearance on the side of the spa with the electronics and 18" of clearance on all other sides to allow easy access for maintenance and repairs. Some periodic maintenance steps require access to the electrical equipment area.



Site Preparation, Delivery & Installation Recommendations

MANUFACTURER'S RECOMMENDED GENERAL INSTALLATION INSTRUCTIONS

It's very important to follow the manufacturer's guidelines for site preparation, installation and leveling of your new Dr. Wellness Spa. Failure to follow these instructions may result in structural damage to the spa that is not covered under your warranty.

SITE PREPARATION FOR OUTDOOR SPAS

- The manufacturer recommends that your spa be installed on a level, concrete pad reinforced with steel bars.
- Before you begin, contact your local gas, electric, water and cable companies to be sure there are no underground lines in the site you have chosen. For best results, site preparation should begin with digging an area that is at least 8" wider and longer than the overall dimension of the spa. The site should be level and 6" to 8" deeper than the final desired elevation of the spa. Depending on the depth of the site, the area should be filled with between 3" and 4" of crushed stone, followed by 3/8" steel reinforcement bars on a 16" grid, then 3" to 4" of poured concrete. Level the concrete and finish with a course broom to ensure it is slip resistant.
- If you live in a climate with freeze/thaw zones or prone to ground shift because of the kind of dirt or low water tables, we recommend installing poured concrete footings that extend below the freeze line or water table prevent the possibility of shifting.
- Make sure the site is away from areas that are prone to flooding or standing water and there is adequate drainage away from the spa. Never backfill the sides of the spa with dirt. If necessary, you should incorporate a retaining wall into the site design that will help ensure the cabinet and electrical components remain dry at all times.
- If your site plan includes decking to give the appearance the spa is recessed, you should choose slip resistant materials for everyone's safety. Water splashing onto the surrounding surface is a normal and should be taken into consideration when choosing decking materials. You should also design the deck to include removable or locking, hinged panels to allow easy access on all four sides for maintenance and service. Remember, making the spa accessible for service is not covered under the warranty.



Site Preparation, Delivery & Installation Recommendations

SITE PREPARATION FOR INDOOR SPAS

- If you are placing your spa indoors you should plan well in advance to prevent the delivery and installation issues that may occur when attempting to get the spa indoors.
- A licensed contractor should confirm the load bearing capacity of the floor is adequate, make modifications like widening the entry point if necessary, installing a floor drain to eliminate standing water, and add a convenient water supply so the water level can be properly maintained.
- Floor coverings should be slip resistant with some ability to grip when the floor is wet.
- The location and floor covering must be able to handle draining all of the water which is part of routine maintenance.
- You should consider installing a ventilation system. Humidity and moisture should be considered. If floor coverings trap water or the drainage is inadequate, wood, paper, and drywall, may get damp creating mold and mildew.
- Some spa chemicals may have an adverse reaction to some household metals. Again, adequate load bearing capacity for the weight of the spa when filled with water and bathers is vital.

PREPARING FOR THE DELIVERY AND OFF LOADING YOUR SPA

- It is important to speak with your sales representative about what to expect at the time of delivery well in advance of the delivery date so you can plan and be prepared on the day of delivery. Failing to adequately prepare in advance will result in delayed delivery. Your spa leaves the manufacturing facility wrapped with protective materials, shrink wrapped with the bottom of the spa banded to a wooden pallet.
- If your spa was purchased from a local Dr. Wellness dealer and you arranged for delivery at the time of purchase, you should discuss potential delivery obstacles like steps, fences and small gate openings with your sales representative in advance so the delivery agent arrives properly equipped and prepared to place your spa without delay.



Site Preparation, Delivery & Installation Recommendations

- If your spa is shipping from the manufacturing facility, it will arrive in a 53' common carrier closed box trailer. The carrier is responsible only for curb side delivery to an address that is accessible not removal or placement of your spa. You will need several people to help remove the spa from the truck on the day of delivery.
- If the prepared site is accessible, hiring a local towing service with a tilting flat bed is a convenient and affordable way to place your spa. You may want to consider meeting the towing service at the destination terminal to inspect the spa and allow the carrier to move the spa onto the flat bed. This is typically an efficient way to coordinate a convenient delivery schedule for everyone and eliminates additional expenses other service providers may charge if the carrier is late for the delivery appointment.
- If placing your spa requires a crane, choose a reputable crane service with spa experience. If the spa is not properly stabilized or the straps are too tight or improperly placed, the spa components and structure may be compromised or broken, even if there is no visible damage at the time. Crane services who are familiar with spa placement know how to properly place spreaders and straps, ensuring the frame is adequately supported.

**NEVER PUT THE SPA ON ITS TOP OR ITS SIDES.
NEVER FLIP THE SPA END OVER END.**

The spa should always be moved with the side that was on the pallet side facing down to prevent damage to the structure, the acrylic and the components.

The manufacturer's warranty does not cover damage that is the result of improper removal or installation of the spa.

LEVELING YOUR SPA

- You should verify the spa is completely level when it has been positioned into place.
- Do not use shims. Shims may create pressure points and damage the spa.
- Damage caused by improper installation is not covered under the warranty.



Electrical Requirements and Recommendations



DANGER! **Risk of Electrocution**



Electrical connections must be performed by a qualified licensed electrician in accordance with the National Electrical Code (NEC) following state and local electrical codes in effect at the time of the installation.

- Connecting the spa to an improperly wired circuit will eliminate many of the spa's built in safety features which may result in fire, electrocution, or other risk of injury. Damages to the spa which are the result of improper wiring are not covered under the manufacturer's warranty and will terminate all listings from independent listing agencies.
- The electrical supply for your spa must be housed in a weatherproof service box and include a suitably rated switch and Ground Fault Circuit Interrupter between the main service entrance and the spa to open all ungrounded supply conductors in compliance with Section 422-20 of the National Electrical Code/USA, ANSI/NFPA/70 and in compliance with independent listing agencies. This might be used as a shut off switch, and must be installed so that it is accessible to the spa occupants, but not within 5 feet (1.5m) of the spa.
- The wiring specifications in this manual are for standard installations where the main power supply is within 40 feet of the spa. If the main power supply is more than 40 feet away, the electrician must make appropriate modifications.
- The electrical instructions and diagrams contained in this manual and inside the spa control box are included as a guideline for the licensed electrician installing the electrical connections and vary by model. Please refer to the wiring diagram inside the spa control box for model specific connection instructions. All wiring connections must be watertight.
- All connections must be made using copper conductors only. Do not use aluminum wire. Connection wires, circuit breakers, and/or fuses, must all be sized to accommodate the Total Ampere load.
- Never turn power on to the spa when it is not filled with water. **DO NOT** connect power to the empty spa. When power is supplied to the spa, it automatically activates critical components within the spa, such as the pumps, controls and the heating. If power is supplied to the components before it is filled with water, the components may be damaged instantly. Damage that occurs to the spa because power was supplied before it is filled with water is not covered by the manufacturer's warranty.
- Prior to performing any service, turn OFF all primary electrical equipment at the main circuit breaker or disconnect panel.
- Your spa must be permanently connected (hard wired) to a power supply that is protected by a Ground Fault Circuit Interrupter (GFCI). Power supplied to your spa must be a dedicated circuit with no other appliances, lighting, or other electronic components powered by the circuit.
- Do not permit any electrical appliances like lights, telephones, MP3 players, radios or televisions within five feet (1.5m) of the



Electrical Requirements and Recommendations



DANGER! **Risk of Electrocutation**



spa unless they were built in by the manufacturer. Failure to maintain a safe distance may result in death or serious injury from electrocution if the appliance should fall into the spa.

- Do not use head phones while using the spa
- All metal components or accessories that are permanently installed, like handrails, ladders, drains and hardware that are within 5 feet (1.5 m) of the spa must be bonded to the equipment grounding bus with copper conductors no smaller than No. 6 AWG.
-

WIRING REQUIREMENTS

- The minimum wire size for 40 and 50 amp systems is # 6/3 c/w ground (6 gauge/4 conductor) if the main power supply is within 40 feet of the spa. If the main power supply not within 40 feet, your electrician should make the appropriate modifications.
- The spa must have dedicated 230V service from the main power supply. Do not attempt to share service with other appliances. Use only a class 'A' double-pole Ground Fault Circuit Interrupter (GFCI).
- To access the spa controls, remove the cabinet panel and store it safely. Do not replace the access panel until the spa is filled with water and you are sure it is operating properly.

ELECTRICAL CONNECTIONS

If your electrician has questions about the wiring instructions, please call Dr. Wellness Spas Technical Assistance prior to starting installation at (877) 722-4097. Factory trained technical service specialists are available to answer questions during their normal business hours, Monday through Friday from 9:00 am to 5 PM EST. Installation of the GFCI and circuit breaker, including ampere sizing and selection of conductor size and type must be performed by a qualified, licensed electrician in accordance with the National Electrical Code, and all Federal, State and Local codes and regulations in effect at the time of installation. Wiring schematics are provided as a reference and are intended only for use only by qualified, licensed electricians.

MODEL SPECIFIC HARD WIRING INSTRUCTIONS ARE LOCATED INSIDE THE SPA CONTROL BOX.



Electrical Requirements and Recommendations



DANGER!
Risk of Electrocutation



Correct wiring of the electrical service box, GFCI box and pack terminal block is required. Your spa requires a 4-wire, 40 or 50 amp (depending on the spa model), 230 volt subfeed in non metallic pipe to the spa equipment compartment.

The black and red wires from the electrical box must be connected to the input of the GFCI.

The white wire from the electrical box must be connected to the neutral bus.

The green or copper wire must be connected to the ground lug of the GFCI.

The black, red and white wires going to the spa must be connected directly to the output of the GFCI.

The neutral to the GFCI must be connected to the neutral bus.

The green or copper wire going to the spa must be connected to the ground lug.

Hard wire the spa controls following the model specific diagram inside spa control box lid. The spa controls are inside the access panels labeled "REMOVE THIS PANEL FOR ELECTRICAL". In most models, the panel is underneath the spa's top side control pad.

Electric Service Requirements

Number of Pumps	Voltage	Breaker	Connection
1	120V	20 amp	Plug In
1	240V	40 amp	Hard Wired
2	240V	50 amp	Hard Wired
3	240V	50 amp	Hard Wired



Electrical Requirements and Recommendations

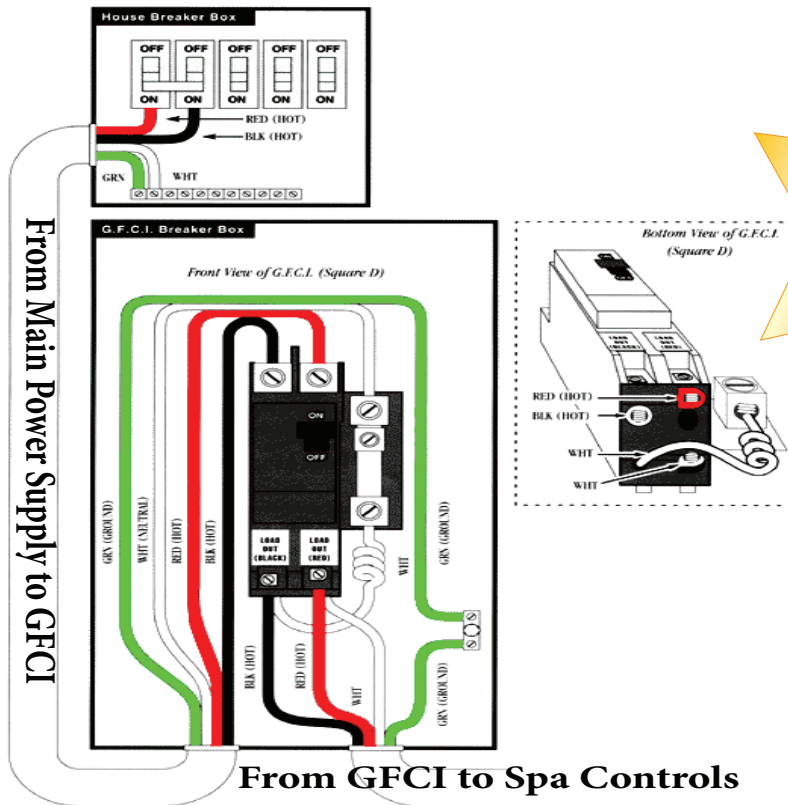

Important!!
 The white neutral wire from the back of the GFCI **MUST** be connected to an incoming service neutral. The GFCI will not work without it. If the incoming white neutral wire is not properly connected, the GFCI will automatically trip. If the GFCI trips when you power on the spa, you should make sure the neutral wire is properly connected.



Filling your Spa with Water

Preparing the Spa for Use

Your spa has been tested during the manufacturing process and some water may remain in the plumbing lines after testing leaving spots on the acrylic or cabinet. Wipe the spa and cabinet with a clean soft rag. Do not use household cleaners that contain bleach or ammonia (including most glass cleaners) because they will have an adverse effect on the surfaces and do not mix with chemicals used to maintain water chemistry. Never use abrasive cleaners on the cabinet, cover or acrylic surface. They may do permanent, irreversible damage. To remove incidental dust, dirt and debris that may have accumulated in the plumbing lines during shipping and installation, open the drain bib and remove the filters, and run water through the filtration canister and jet lines until the water coming from the drain bib runs clear.

Never attempt any kind of service or cleaning when power is applied to the spa. Each time you remove the spa cabinet for any reason, manually turn the GFCI off. Never leave the spa unattended while the exterior panels or cover are off the spa.



BASE WATER QUALITY



What's in your water? The answer is different for just about everyone. Water provided by public utility systems must meet strict standards requiring chemical treatment before it flows through your faucets. Even though quality standards are similar regardless of where you live, the treatment required to meet that standard, and the residual chemicals that remain in your water after treatment can vary greatly. Water flowing from faucets in Washington State is different than the water flowing from faucets in Oregon, Texas and Florida. Water delivered directly from a well is untreated and water that passes through a softening system receives an additional treatment. Whether your water is treated or untreated, filtered or unfiltered, all water delivers trace amounts of something that can negatively affect the performance of your spa.

Do not fill the spa with water from a well water or water softener.

Do not use hot water when you fill your spa.

Do not use water that has passed through a water softener system.

Using well water is not recommended. Well water often has higher mineral, metal and bacterial content that will damage the spa components and makes water chemistry maintenance difficult. If you must use well water to fill your spa, you should get professional assistance.

If you are having difficulty with your water chemistry, you should consider having your tested locally to determine the appropriate treatment.



Filling your Spa with Water



DANGER!
Risk of Electrocutation



Step by Step Instructions to Fill the Spa with Water



1. Remove the access panel marked **“REMOVE THIS PANEL FOR ELECTRICAL”**. In most models, this access panel is underneath the top side controls. Remove all of the screws that attach the access panel to the spa frame.
2. Check for obvious signs of damage inside the cabinet including loose wires or broken pipes. If you see damage inside the spa cabinet, call a technical service associate at 844-894-6659 for assistance and repair
3. Hand tighten the plumbing unions and check to be sure the slice valves are locked and in the “up” position. If the slice valves are not in the up position, pull the “T” stem all the way up to open the slice valves. Lock the “T” stem and attach the clip locks. Never operate the spa when the slice valves are closed. Damage that occurs because the spa was powered on when the slice valves were closed is not covered by the manufacturer’s warranty.
4. With the slice valves locked in the up position and the unions hand tightened, remove the weir, skimmer basket and filters from the filtration canister.
5. Lay the weir(s) and the filter basket(s) safely to the side. Place the filter(s) inside the foot well of the spa as the spa fills with water allowing filter(s) to saturate. Never install dry filters in your spa.
6. Place a garden hose in the empty filter canister. Turn the water on. Adding water through the filter canister fills the pumps and internal plumbing lines with water, reducing the risk of an air lock in the pumps(s) when power is applied. When the low plumbing lines are filled, water will begin flowing into the foot well, and move upward inside the spa. Continue filling the spa until the water level is approximately one inch over the highest jets, excluding jets that are designed for neck and shoulder massages. Failure to add enough water prevents adequate flow damaging the pumps and heater. Damage that occurs because the spa is not filled properly or from improper water levels is not covered under the manufacturer’s warranty.
7. Remove the garden hose and turn the water off.



Filling your Spa with Water

8. Replace the filter, skimmer basket and weir.
9. Check for leaks inside the spa cabinet, especially at the plumbing unions near pump(s) and heater. Hand tighten unions if necessary. If the spa is leaking and the unions are tight do not turn the GFCI on. Call a technical service associate at 844-894-6659 for assistance and repair before applying power to the spa.
10. If there are no visible leaks inside the cabinet, turn the GFCI “on”
11. When power is applied to the spa, the spa controls will immediately begin a self check cycle, which can take up to 30 minutes.

Do not touch the buttons on your topside controls until the prompt appears on the topside display!

The model specific topside control instructions will help you determine when it is safe to begin setting your preferences. Make sure water is circulating through all jets, that the air controls, diverter and waterfall valves are functioning properly. If the spa is functioning properly and there are no leaks inside the spa cabinet, reinstall the cabinet access panel.



THE WATER LEVEL



There's a fine line between too much water and not enough. If the water level is too low, air is sucked into the plumbing lines which causes serious damage to the spa. If the water level is too high, lighting and audio components become submerged causing them to fail prematurely. So how do you know when enough is actually enough?

It's important to pay attention to the water level as bathers enter and exit the spa. The number of gallons displaced by one person is lower than the number of gallons displaced by six people and the number of gallons displaced by six children who weigh 50 pounds is lower than the number of gallons displaced by six adults who weigh 150 pounds. What may be the perfect water level for six children may cause the spa to overflow with six adults, but six children might splash out more water than six adults displace. You should expect to add or remove water depending upon use. Every time you exit the spa, check the water level and add water if necessary.

The water level will vary depending upon the spa model you purchased. As a general rule, when the spa is empty the water level should be at least 4 inches over the filter basket and below the perimeter lighting and audio components.

Re-Filling your Spa with Water

Follow these step by step instructions every time you re-fill the spa to ensure successful start up. If you need to replace the screws on the cabinet, use stainless steel screws which do not rust.





Topside Control Instructions for Spas with 2 Pumps

Programming Menu Sequence

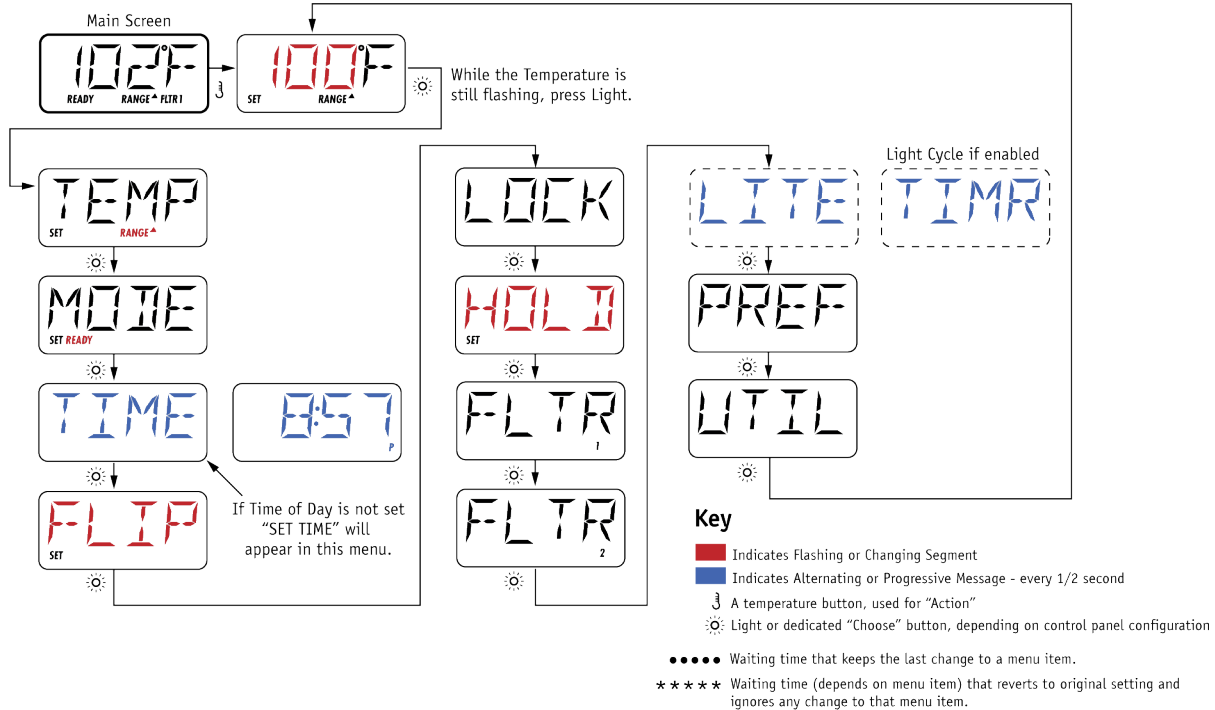

Powering on Your Spa

After filling the spa through the filter assembly to the correct level remove the water hose, replace the filter, the filter basket assembly and the filter cover. Turn the GFCI on. Every time the GFCI is powered on, your spa controls run diagnostic tests. During diagnostic testing, a series of messages are displayed on the topside controls. When diagnostic testing is complete, the spa begins priming mode.

Priming Mode

Each time you fill your spa some air may be trapped in the plumbing lines. Priming mode safely removes the air. To prevent failure, the heater is disabled during priming mode. Pumps should be observed one at a time. Your spa will automatically begin normal heating and filtering when priming is complete. Priming mode lasts approximately 5 minutes.

Run Pumps to Purge the Air

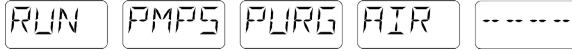

When this message is displayed on your topside controls, push the “Pump 1” button once to start the pump on low speed. Press the “Pump 1” button a second time to switch to high speed. After confirming water is coming from all jets and the pump is not surging, press the “Pump 1” button to turn the pump off.



Pump 2 is a single speed pump. Press the “Pump 2” button once to start Pump 2. After confirming water is coming from all jets and the pump is not surging, press the “Pump 2” button to turn the pump off.



If the spa you purchased has 3 pumps, Pump 3 is a single speed pump. Press the “Pump 3” button to start Pump 3. After confirming water is coming from all jets and the pump is not surging, press the “Pump 3” button to turn the pump off.

Within 2 minutes of pressing each pump button, water should be flowing from the jets in every seat without surging. If none of the jets in a seat work or if water surges, turn the pump off. After the water is completely still, repeat the process a second time. If the pumps do not prime within 2 minutes on your second attempt, turn the GFCI off. Make sure the slice valves are locked in the OPEN position, that the diverter valves are centered for even distribution of the water, that jets without flow are rotated to the open position and remove any debris in the filter basket and on suction drain covers. Power the GFCI on and repeat the process to run each pump on HIGH SPEED. If the pumps don't prime on the third attempt, call 844-894-6659 for assistance.

Do not turn on any pump that will not prime. A pump that fails to prime should not be left on for more than 2 minutes under any circumstance. The heater will engage when priming mode is complete. If a pump is not properly primed when the heater engages, the spa may overheat causing serious damage.



Pre-Programmed Factory Settings

Your spa will start in Ready Mode

The temperature is pre-programmed to 100° F

The Duel Temperatures are pre-programmed to a minimum of 80° F and a maximum of 104° F

The filtration cycle is pre-programmed to run once each day for 2 hours

Initial Temperature Display



After briefly displaying the pre-programmed temperature setting, this message will be displayed on your topside controls. The water must circulate through the heater chamber for approximately one minute before the current water temperature can be displayed on the topside controls. When the water temperature reaches the pre-programmed temperature setting, the pump will turn off automatically. To display the current pre-programmed temperature setting, press the “Temp” button once. The current water temperature will flash on the display.

When the display is flashing, the spa controls are in programming mode. To prevent accidentally changing pre-programmed settings, after you press a button, you should wait 5 seconds before pressing a different button.

Turning the Jets On and Off



Pump 1 is a two speed pump. Press the “Pump 1” button to operate pump 1 on LOW SPEED. Press the “Pump 1” button a second time to operate on HIGH SPEED. Press the “Pump 1” button a third time to turn it off. If the “Pump 1” button is not pressed to turn it off manually, it will shut down automatically after 20 minutes. To turn it back on, press the “Pump 1” button and repeat the process. *The Ozonator engages when pump 1 is operating on LOW SPEED.*



Pump 2 is a single pump. Press the “Pump 2” button to turn it on. Press the “Pump 2” button a second time to turn it off. If the “Pump 2” button is not pressed to turn it off manually, it will shut down automatically after 20 minutes. Press the “Pump 2” button to turn the pump back on.



In spas equipped with 3 pumps, pump 3 is a single speed pump. Press the “Pump 3” button to turn it on . Press the “Pump 3” button a second time to turn it off. If the “Pump 3” button is not pressed to turn it off manually, it will shut down automatically after 20 minutes. Press the “Pump 3” button to turn it back on.



To ensure your safety and for optimal performance, your spa controls will automatically perform maintenance functions and run diagnostic testing. The pump will start automatically on low speed to circulate the water for a few minutes every hour to run a system check. During heating, filtration and diagnostic testing the pump runs on low speed. When the pump starts automatically and operates on low speed to perform these maintenance functions, pressing the pump button will not turn the pump off. When a button is pressed to turn a pump on, a clean up cycle will begin 30 minutes after the pump shuts down. The pump will operate on LOW SPEED and the ozonator will engage. Both the pump and ozonator will operate for approximately 30 minutes to help eliminate dirt, bacteria and other particulates as soon as they are introduced to the water.

Turning the Lights On and Off



Press the “Light” button once to turn the lights on. The colored light will rotate. Press the “Light” button to turn the light off. To display only one color, press the “Light” button repeatedly turning the lights on and off. When the color your desire turns on do not turn the light off. Press the button only when ready to turn the light off. If the “Light” button is not pressed to turn the lights off manually, the lights will turn off automatically after 2 hours. Press the “Light” button to turn the lights back on. If your spa is equipped with optional perimeter lighting, the perimeter lighting feature work in tandem with the main light.

Operating the Audio Components



Press the “Stereo” button to turn the built in audio components on. Press the “Stereo” button a second time to turn them off. If the button is not pressed to manually power off the audio components, they will power off automatically after 2 hours. Press the “Stereo” button to turn it back on. Music from your Mp3 player will play through the built in audio components when your device is plugged into the audio jack. The Mp3 Cargo Bay is built into the spa cabinet on the same side as the topside controls. Use your Mp3 player to select music and to control the volume. If the model you purchased is equipped with Bluetooth capability, open the Bluetooth settings on your Mp3 player and connect it to the spa to stream your music wirelessly. Enter “0000” if a pairing code is required.

For your safety and to protect your device, your Mp3 player should always be stored in the Mp3 Cargo Bay. When you remove your Mp3 player from the Cargo Bay, always press the “Stereo” button to turn the speakers off. Leaving the audio components on causes overheating that will permanently damage the audio components. Damage to the audio components that occurs because the components were not turned off is not covered under the warranty.



Changing the Programmed Settings and Operating Modes

Press the “Temp” button once to enter programming mode.

When the display on the topside control is flashing, the spa is in programming mode.

In most cases, pressing the light button saves the change.

To prevent accidentally changing programmed settings, after pressing one button wait 5 seconds before pressing a different button.

Adjusting the Programmed Water Temperature Setting



To change to programmed temperature settings, press and release the “Temp” button. The display on the topside controls will flash, indicating you have entered programming mode. While the display is still flashing, press and hold the “Temp” button until the desired temperature is reached. To move the temperature in the opposite direction, continue holding the button. The temperature will automatically begin moving in the opposite direction when the maximum temperature is reached. Release the “Temp” button when the desired temperature is displayed on the topside controls. Press the light button to save the change and exit programming mode. If the programmed temperature is increased, pump 1 will turn on automatically to begin heating the water.



Dual Temperature Ranges



When you are setting Dual Temperature Ranges, pay attention to the direction of the arrow displayed on the topside controls.

The spa controls allow you program two temperature range settings with independent temperature settings that are most commonly used to program a “Ready to Use” setting and a “Vacation” setting. When a range is chosen, the spa will heat to the temperature settings associated with that range. For example, the high range might be set with a low temperature of 80° F and a high temperature of 104° F and the low range might be set between 60° F and 99° F. Freeze protection is active in either range.

To program the first temperature range, press the “Temp” button. While the display is flashing, press the “Light” button. “TEMP” will be displayed on the controls. If the arrow beside the word “RANGE” is pointing up, program the HIGH temperature setting. If the arrow is pointing down, program the LOW temperature. Press and hold the “Temp” button until the desired temperature is reached. Press the “Light” button to save the change. Repeat the process to program the opposite temperature range. If necessary, press the “Temp” button to change the direction of the arrow. Press and hold the “Temp” button until the desired temperature is reached. Press the “Light” button to save the changes.



Setting Dual Temperature Ranges

Key

- Indicates Flashing or Changing Segment
- Indicates Alternating or Progressive Message - every 1/2 second
- ⌋ A temperature button, used for "Action"
- ☀ Light or dedicated "Choose" button, depending on control panel configuration

- Waiting time that keeps the last change to a menu item.
- ***** Waiting time (depends on menu item) that reverts to original setting and ignores any change to that menu item.

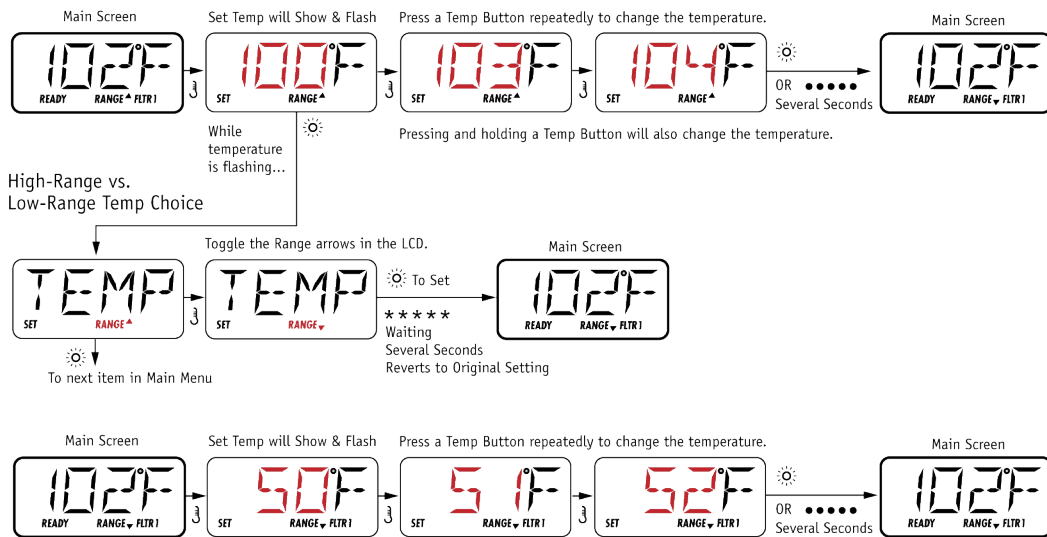

Freeze Protection



If the water temperature falls to 42° F, the spa will automatically turn on and will run for 4 minutes after the water temperature reaches 46° F to prevent freezing. If your spa is in Sleep Mode when the ambient temperature is 40° F or lower, the water temperature will likely operate in Freeze Protection Mode for extended periods if not continuously.

Show and Set the Time-of-Day



Setting the time of day is important for determining when filtration cycles and other functions will be performed. If no time of day is set, "SET TIME" will flash on the display if no time-of-day is stored in the memory. When the power supply to the spa is interrupted, the time will not be saved. If filtration cycles must be run at a particular time resetting the time-of-day will be required. When the GFCI is powered on, the default time-of-day is 12:00 Noon. Though "SET TIME" will still flash on the display, if the GFCI is powered on at Noon, the filtration cycle will run at Noon.



To set the time of day, press the "Temp" button. While the display is flashing, repeatedly press the "Light" button until "TIME" appears on the topside display. To set the HOUR, press and hold the "Temp" button until the correct hour is displayed. Press the "Light" button to save the hour and begin setting the MINUTES. Press and hold the "Temp" button until the correct time is displayed. Press the "Light" button to save your selection.



Flip the Display



The message on the topside display can be inverted for easy reading both inside and outside the spa. To invert the display, press the "Temp" button once. When the display is flashing, press the light button repeatedly until the word "FLIP" flashes on the topside controls. Press the "Temp" button to invert the display. "FLIP" will begin flashing in the inverted direction. Press the "Light" button to save the change.



Setting the Time of Day

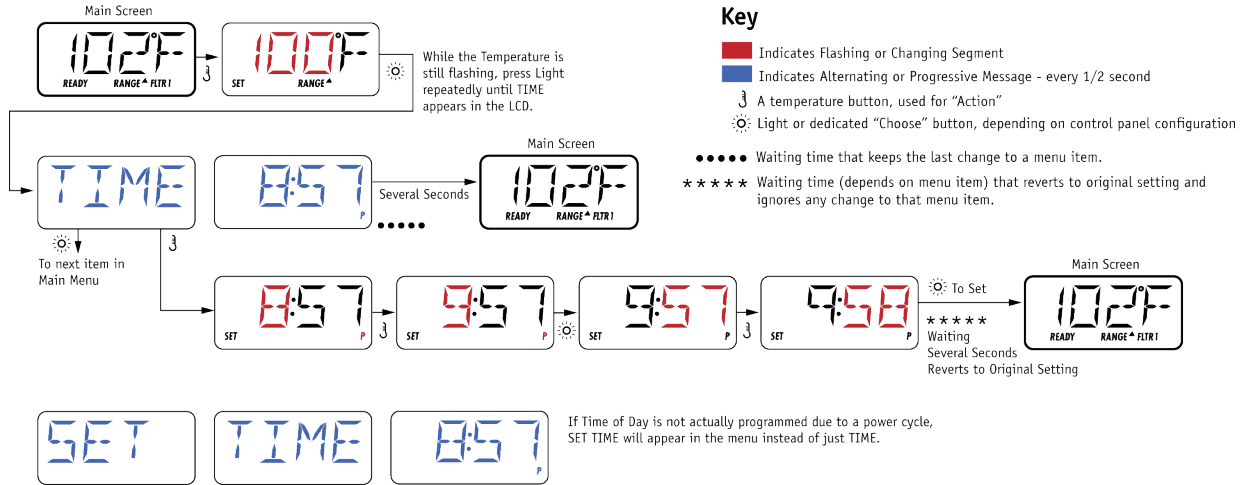

Flipping the Display

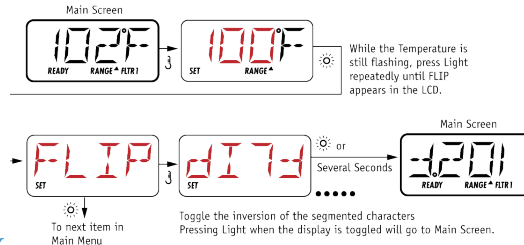

Programming Filtration Cycle Settings

Your spa is pre-programmed to filter once each day for 2 hours.

When the filtration cycle begins, all pumps will turn on and operate on HIGH SPEED to purge the lines and shut down automatically.

When purging is complete, Pump 1 will start on LOW SPEED and will automatically shut down when filtration cycle is complete.

During filtration cycles, the water circulates to remove debris and small particulates.

Increasing filtration will not eliminate or reduce the need for chemical sanitization.

How long your water needs to filter varies on a number of factors including how often the spa is used, for how long, and by how many people. In addition to the filtration cycle, the water circulates every 30 minutes for diagnostic testing and during clean up cycles that begin automatically 30 minutes after a pump button is pressed. Under normal use, adequate filtration should be achieved in two hours. If the spa is used for longer periods by more bathers it may be necessary to increase the duration of your filtration cycle which should not exceed 4 hours. Excessive filtration in may cause overheating. Your spa is pre-programmed to run one filtration cycle every day for two hours. You can program when the filtration cycle will begin and the duration. Settings can be adjusted in 15 minute intervals.



To program filtration cycles, press the “Temp” button, While the display is flashing, repeatedly press the “Light” button until “FLTR” is displayed on the topside controls. Press the “Temp” button. While “BEGN” is flashing on the display, press and hold the “Temp” button until the correct hour is displayed. Press the “Light” button to save the hour and move to minutes. Press and hold the “Temp” button until the desired 1/4 hour is displayed. Press the “Light” button. While “RUN HRS” is flashing press and hold the “Temp” button until the desired number of hours is displayed. Press the “Light” button to save the selection and move to minutes. Press and hold the “Temp” button until the correct 1/4 hour is displayed. Press the “Light” button to save the selection and display the time of day the filtration cycle will end. Press the “Temp” button to save the selection.



When selecting the start time pay close attention to “A” or “P” in the bottom right corner of the display. The filtration cycle will run during the AM if “A” is displayed or PM if “P” is displayed. The system calculates the end time, so “A” or “P” are not included in that display.



Programming the Filtration Cycle

Key

■ Indicates Flashing or Changing Segment

■ Indicates Alternating or Progressive Message - every 1/2 second

⌋ A temperature button, used for "Action"

☉ Light or dedicated "Choose" button, depending on control panel configuration

●●●●● Waiting time that keeps the last change to a menu item.

***** Waiting time (depends on menu item) that reverts to original setting and ignores any change to that menu item.

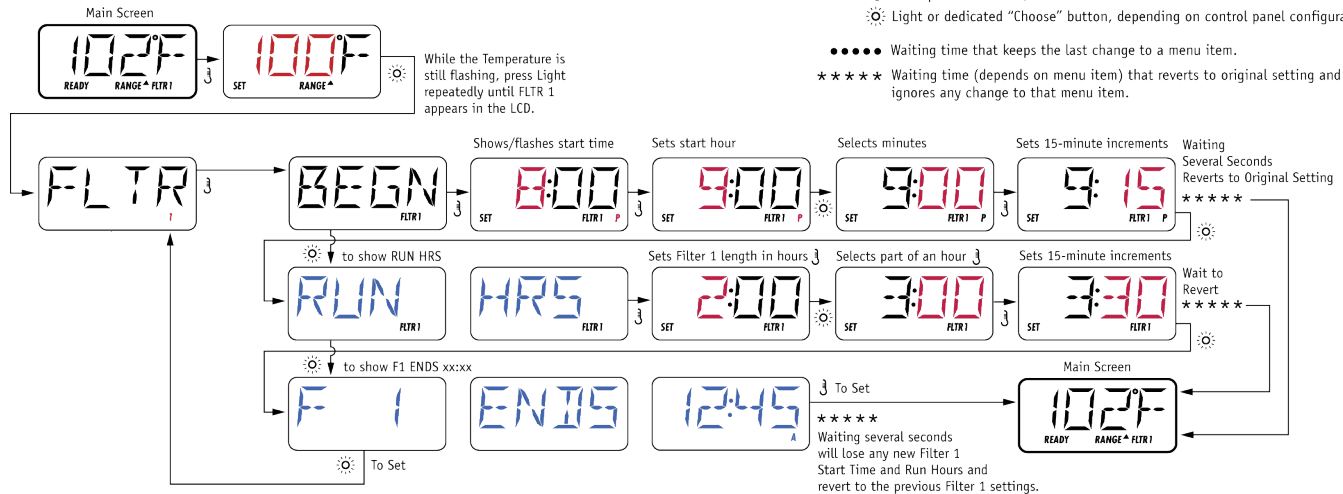

UNDERSTANDING OPERATING MODES

Your spa controls are equipped with three operating modes to help you regulate energy consumption and reduce operating costs. How often the spa is used and the ambient temperature will help you determine which mode is best for you.



Ready Mode

The water is always heater to the programmed temperature setting.

"Ready" is displayed on the topside controls.

When the spa is in Ready Mode, it's always ready to use when you're ready to use it because the programmed temperature setting is automatically maintained. The current water temperature will be displayed on the topside controls. Pump 1 will automatically circulate on low speed for a few minutes every half hour to check the water temperature keeping it consistent throughout the spa and to sanitize the water with Ozone.



Rest Mode

The water only heats during filtration cycles and may be too cool for immediate use

"Rest" is displayed on the topside controls.

DO NOT PUT THE SPA IN REST MODE WHEN THE AMBIENT TEMPERATURE IS 40° F OR LOWER!

Rest Mode reduces energy consumption by heating the water only during filtration cycles only. In Ready Mode, the water automatically begins heating when the temperature falls a couple of degrees. In Rest Mode, the water temperature is allowed to fluctuate. When the spa is in Rest Mode, setting the filtration cycle to end right before use can be an effective way to reduce energy consumption. The topside controls will not display the current water temperature until pump 1 is turned on to circulate the water for approximately 1 minute.

Ready-In-Rest Mode



*In Rest Mode, the water heats for 1 hour when the "Pump 1" button is pressed
Unless the "Pump 1" button is pressed, the water only heats during filtration cycles.*

In Ready-In-Rest Mode the spa will operate in Rest Mode, heating only during filtration cycles, unless the "Pump" 1 button is pressed. When the "Pump 1" button is pressed, the system assumes it is in use and the water begins heating as it circulates for one hour. If the programmed temperature setting isn't reached within the hour, the pump automatically shuts off.

To change operating modes, press the "Temp" button. While the display is flashing, repeatedly press the "Light" button until "MOJE" appears on the topside display. Press the "Temp" button to toggle between operating modes. When the desired mode is displayed, press the "Light" button to save your selection.



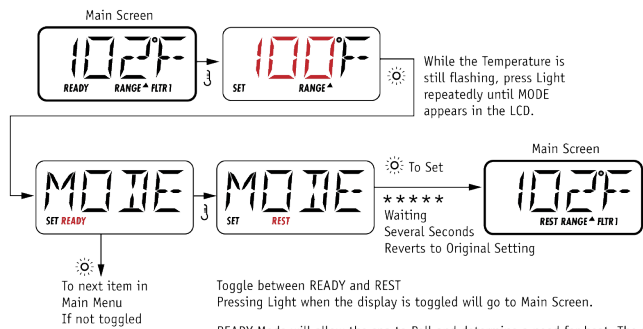

Key

- Indicates Flashing or Changing Segment
- Indicates Alternating or Progressive Message - every 1/2 second
- ↵ A temperature button, used for "Action"
- ☀ Light or dedicated "Choose" button, depending on control panel configuration
- Waiting time that keeps the last change to a menu item.
- ***** Waiting time (depends on menu item) that reverts to original setting and ignores any change to that menu item.

READY Mode will allow the spa to Poll and determine a need for heat. The panel will maintain a "current" temperature display.

When your spa is in Rest Mode, the actual water temperature cannot be displayed until Pump 1 is screened on to circulate the water.

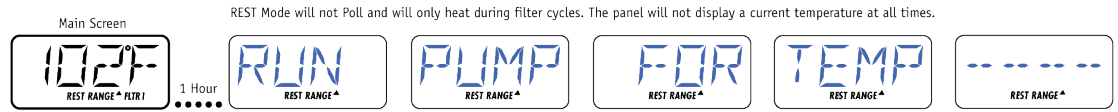

REST Mode will not Poll and will only heat during filter cycles. The panel will not display a current temperature at all times.

The Main Screen will display RUN PUMP FOR TEMP if the filtration pump has not run for over 1 hour.
The Main Screen will display normally during Filter Cycles or when the spa is in use.

If the filtration pump has been off for an hour or more, when any function button, EXCEPT Light, is pressed on the panel, the pump used in conjunction with the heater will run so that temperature can be sensed and displayed.



Restricting Access

To prevent unwanted use or accidental changes to programmed settings, lock the control panel to block use of the topside controls without interrupting the automatic functions.

Limited Access



Locking the Temperature allows the Jets and other features to be used, but blocks access to other menu items including the programmed temperature setting, “FLIP”, “LOCK,” “INFO” and “FAULT LOG”.



To lock the Temperature, press the “Temp” button once. While the display on the topside control is flashing, press the “Light” button repeatedly until “*LOCK*” is displayed on the topside controls. Press the “Temp” button. When “*TEMP*” is displayed, press the “Light” button. When “*PANL*” is displayed, press the “TEMP” button. When “*OFF*” appears on the display, press the “TEMP” button. When “*ON*” is displayed, press the “Light” button to lock and save the changes. When the Temperature Lock is activated, the word “*LOCK*” will appear when the “Temp” button is pressed twice.



Unlocking



Press and hold the “Temp” button. Slowly press the “Light” button twice. The control panel is unlocked when “*UNLK*” is displayed on the topside control panel.



To lock the topside control panel and prevent use, press the “Temp” button once. While the display on the topside controls is flashing, press the “Light” button until “*LOCK*” is displayed on the topside controls. Press the Temp Button once. When “*TEMP*” appears on the display, press the “Light” button once. When “*PANL*” is displayed, press the “Temp” button. When “*OFF*” is displayed, press the “Temp” button. When “*ON*” is displayed, press the “Light” button save the change and lock the controls. When the panel lock is activated, “*LOCK*” will appear when any button is pressed.



Restricting Access

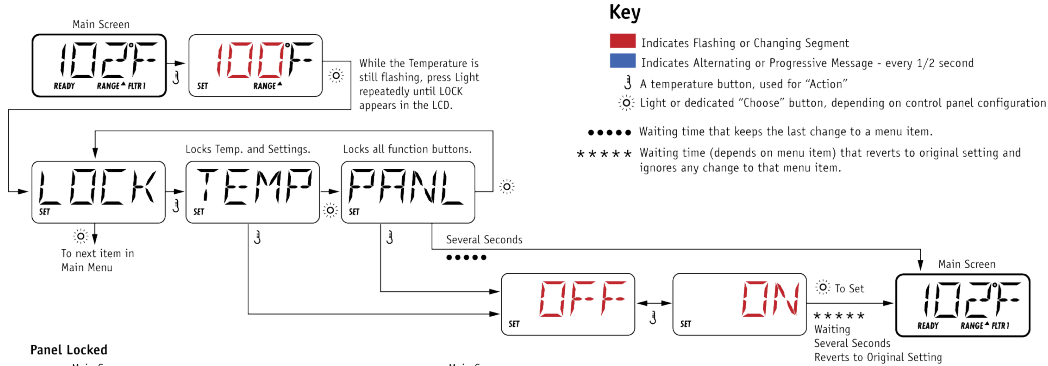

Panel Locked



Temperature Locked



When the Temperature is locked, the panel will display the Set Temperature by pressing a Temperature Button, as usual.
LOCK will appear if an attempt to reset the temperature is made with a subsequent button press.

Unlocking the Controls

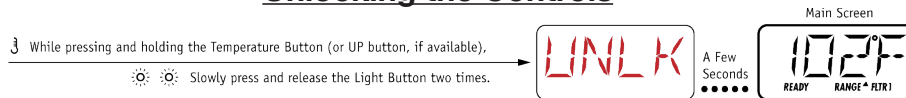

Setting Preferences

Selecting °F OR °C

To change the water temperature reading from Fahrenheit to Celsius, Press the “Temp” button once. While the display is flashing, press the “Light” button until “*PREF*” is displayed. Press the “Temp” button. When “*F / C*” is displayed, press the “Temp” button to toggle between “*F*” and “*C*”. Press the “Light” button to set your preference. “*PREF*” will display on the control allowing you to set the next preference parameter. The system will automatically exit if the setting is not adjusted while “*PREF*” is flashing on the display.

Selecting Standard or Military Time

To change the clock setting to Military Time, press the “Light” button. “*24- 12*” will be displayed on the topside control. Use the “Temp” button to toggle between “*24 HR*” and “*12 HR*”. Use the light button to set your preference. “*PREF*” will display on the control.

Setting Maintenance Reminders

To set maintenance reminders, press the “Light” button when “*RE--*” “*MIN-*” “*DEFS*” is displayed. Press the “Temp” button to toggle between “*YES*” and “*NO*”. Press the “Light” button to set your preference.



Setting Preferences

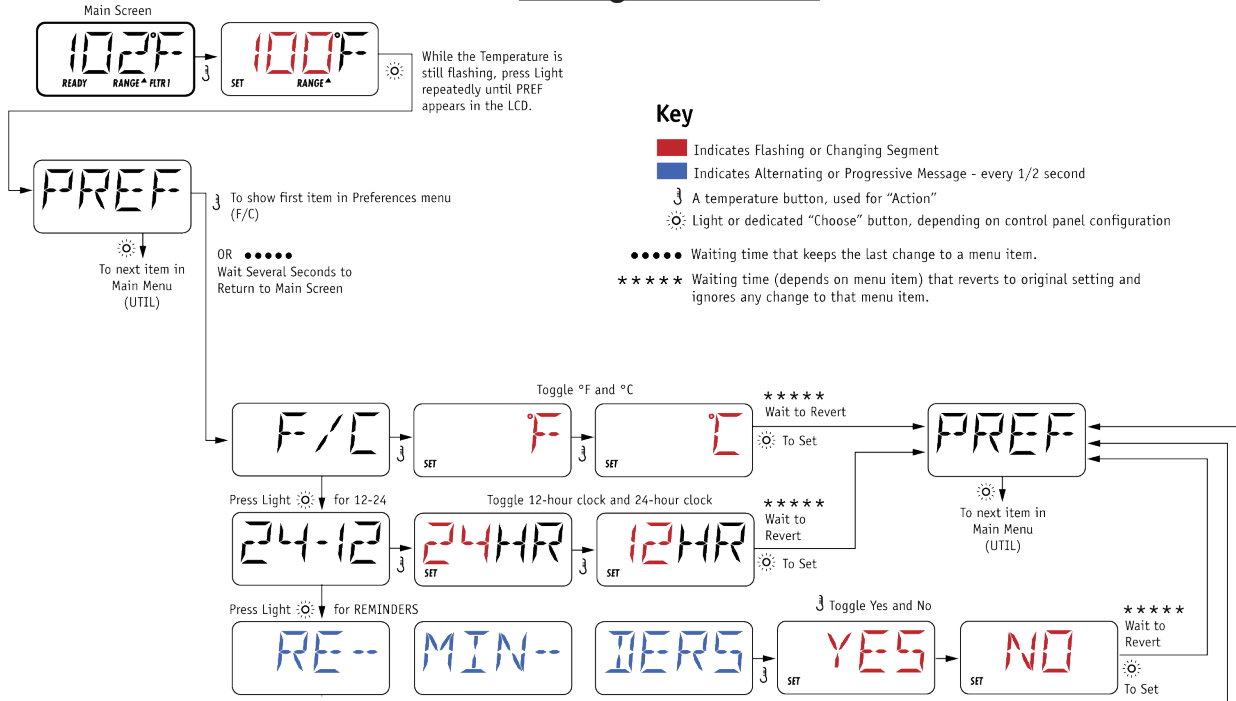

Key

Indicates Flashing or Changing Segment

Indicates Alternating or Progressive Message - every 1/2 second

A temperature button, used for "Action"

Light or dedicated "Choose" button, depending on control panel configuration

Waiting time that keeps the last change to a menu item.

 Waiting time (depends on menu item) that reverts to original setting and ignores any change to that menu item.

General Messages

Too Cold - Freeze Protection



A potential freeze condition has been detected and all pumps have been activated. Pumps will stay on for at least 4 minutes after the potential freeze condition has ended. Pumps may turn on and off automatically during freeze protection.

Water is too Hot



One of the temperature sensors has detected high temperature in the heater chamber and spa functions have been disabled. DO NOT ENTER THE WATER! The probable cause is pumps running excessively or high ambient temperatures. Remove the spa cover and add water allowing the water to cool. Reduce duration of filtration cycle. Operation will resume when the water temperature has fallen.



Heater Related Messages

Reduced Heater Flow HTR FLOW LOSS -----

There may not be enough water flow away from the heater. DO NOT ENTER THE WATER! Water temperature readings in the heater chamber are too high. Heater will restart in approximately 1 minute.

Reduced Heater Flow HTR FLOW FAIL -----

Not enough flow to carry water away from the heating element and the heater has been disabled. DO NOT ENTER THE WATER! Power off GFCI, make sure slice valves locked in open position, that water level is adequate and remove debris from filter, filter basket and suction drain cover. Press any button to resume operation. If problem is not resolved, call 844-894-6659 for assistance.

Heater may be Dry HTR MAY BE DRY ----- WAIT -----

There is not enough water in the heater. Add water to the spa if the water level is too low, check to be sure slice valves are locked in the open position, that pumps are primed and jets are open. When problem is resolved, press any button to resume operation.

Heater is too Hot HTR TOO HOT -----

One of the temperature sensors has detected high temperature in the heater chamber and the spa is shut down. DO NOT ENTER THE WATER! Power off GFCI, make sure slice valves locked in open position, that water level is adequate and remove debris from filter, filter basket and suction drain cover. Press any button to resume operation. If problem is not resolved, call 844-894-6659 for assistance.



Reset GFCI PRES BTTN TO RSET -----

When this message appears with another message, the GFCI must be turned off to reset the spa controls. After 10 minutes, turn the GFCI on.

Sensor Related Messages 102F SNSR BAL -- ANCE
READY RANGE - 110F

Sensor Balance is Poor - Temperature sensors are out of balance by 2 to 3 Degrees. Call 844-894-6659 for assistance.

Sensor Balance is Poor SNSR SYNC ----- CALL FOR SRVC -----

Temperature sensors are out of balance and fault has been established for at least 1 hour. Call 844-894-6659 for assistance

Sensor A Failure SNSR A ----- CALL FOR SRVC -----

Temperature sensor or sensor circuit (A) has failed. Call 844-894-6659 for assistance.

Sensor A Failure SNSR B ----- CALL FOR SRVC -----

Temperature sensor or sensor circuit (B) has failed. Call 844-894-6659 for assistance.



Miscellaneous Messages

No Communication

NO

COMM

The topside control is not communicating with the spa controls. Call 844-894-6659 for assistance.

Pre-Production Software

BETA

VER--

SION

The spa controls is operating with test controls. Call 877-722-8097 for assistance.

°F or °C replaced by °T

TEST
READY RANGE °F/°C

Spa controls are operating in Test Mode. Call 844-894-6659 for assistance.

Memory Failure

MEM

FAIL

When the spa was powered on the system failed the Program Checksum Test. There is a problem with the firmware. Call 844-894-6659 for assistance.

Memory Warning - Persistent Memory Reset

MEM

RSET

Message appears after system set up change. If this message appears on more than one power up, or it appears after operating normally for a period of time, call 844-894-6659 for assistance.



Memory Failure - Clock Error CLOK FAIL -----

Call 844-894-6659 for assistance.

Configuration Error - Spa will not Power On CNFG FAIL -----

Call 844-894-6659 for assistance.

GFCI Failure - System could not Test/Trip GFCI GFCI FAIL -----

Take pictures of the GFCI and the main power supply and have them ready to email to technical support. Call 844-894-6659 for assistance.

Pump appears to be stuck on STLK PUMP -----

Water may be overheating.

Pump appears to have been stuck ON when the spa was last powered on

HOT FALT ----- CALL FOR SRVC -----

DO NOT ENTER THE WATER. Turn the GFCI off and call 844-894-6659 for assistance.



If Reminders are Programmed, These Messages will Appear on a Regular Basis Alternating with Current Water Temperature

Check pH and adjust if required. [CHEK] [PH]

Check sanitizer and adjust if required. [CHEK] [CHEM]

Clean or replace the filter if necessary. [CLN] [FLTR]

Test the GFCI. [TEST] [GFCI]

The manufacturer requires installation of a Ground Fault Circuit Interrupter by a qualified, licensed electrician. The GFCI is an extremely important safety device and must be checked on a regular basis to verify its reliability.

Change water to maintain chemical balance and sanitary conditions. [CHNG] [WATR]

Clean and condition cover for maximum life. [CLN] [COVR]

Clean and condition cabinet for maximum life. [TRT] [WOOD]

Change filter to ensure adequate water flow, optimal performance and sanitary conditions. [CLN] [FLTR]

Install new mineral cartridge to ensure adequate sanitation. [CHNG] [CART]



Getting to Know Your Spa

The Electronic Components

The Topside Control is like the keyboard for a computer. Just like pressing “enter” on a keyboard gives your computer the command to visit a specific website, pressing a button on the topside control relays the command to perform a specific action. Temperature, filtration, lighting, energy consumption and jet functions are all controlled with the press of a button on the topside control. Specific functions vary depending upon model you purchased. In addition to controlling spa performance, the topside control also relays diagnostic and error messages. Diagnostic and error messages displayed on the topside controls will alert you if a problem is detected, many of which can be corrected simply by turning the GFCI “OFF” for 30 minutes and then turning the GFCI back “ON”, also known as a “system reset”. If you receive an error message that is displayed after resetting the system, please refer to the error message section of the manual and follow the instructions or call a technical support representative at 844-894-6659 for additional assistance.

The Spa Pack is the computer that accepts the command to perform a specific function. Pressing a “pump” button starts communication between the spa pack and that pump forcing water into the spa through the jets associated with the corresponding pump. The spa pack is designed to automatically take care of many of the maintenance and safety features so you don’t have to. For example, if the water temperature falls below the programmed temperature setting, the spa pack will automatically turn on the heater and a pump to circulate water until the water reaches the correct temperature. In addition, the pack runs and retains the results of diagnostic tests to ensure your spa operates with optimal efficiency. If an error message appears on your topside control, or if your spa fails to respond to commands from the topside control, please call a technical support representative at 844-894-6659 . If you are asked to remove the spa control cover, you should manually turn the GFCI “off” before removing it.

The Spa Heater warms the water in the spa. When the water temperature falls below the programmed temperature ranges, the spa will automatically turn the heater on and begin circulating the water until the correct temperature is reached. The heater and pumps will turn on and off automatically to maintain temperature settings. Spas are designed to keep water warm and prevent heat loss. If the water temperature setting is higher than the ambient temperature, and the ambient temperature does not decrease enough to cool the water in the spa, the temperature of the water in the spa may be higher than the programmed temperature setting. To lower your water temperature, you should partially remove the cover for a short period of time allowing heat to escape or drain some of the water from the spa and add cool water. If you drain water from the spa, you should manually turn the GFCI “off” and follow the instructions for filling your spa.



Getting to Know Your Spa

Plumbing Components

The *Drain Bib* is used to remove the water from the spa. The drain is located near one corner at the base of the spa. Check to be sure the drain bib is closed and no water is draining from it when you fill the spa.



DISPOSING OF WATER



Because heavily treated water may be harmful to the environment and because some areas are prone to flooding, some communities regulate or restrict the disposal of the water from your spa. Typically, if the pH & chemical levels are correct, you can drain the water on your own lawn provided there is no potential of erosion or flooding to surrounding properties or storm drains.

Check with local officials before you drain your spa.

Using the Drain Bib to Empty your Spa

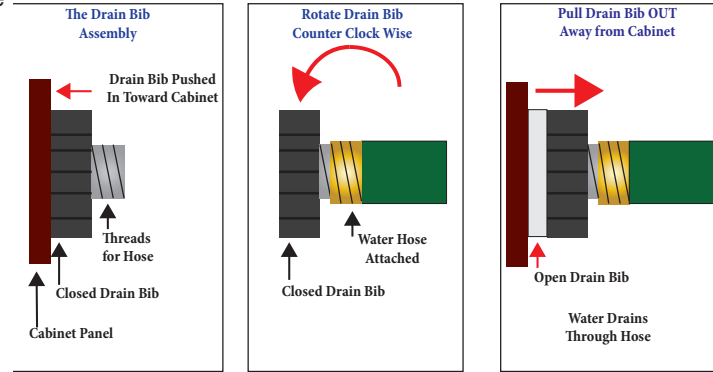

The *Spa Pump(s)* push water through the plumbing lines into the jets. Pumps are turned on and off by pressing the button(s) on the topside controls. The number and speed of the pumps varies by spa model.

The pump is designed to pump water, not air. If air is in the pump or the plumbing lines, the air will prevent circulation of the water. Letting your pumps run with an air locked in the lines will instantly destroy the pump(s). Filling the spa properly and “bleeding” the pump prior to powering the spa on will help prevent air locks. If you hear a “humming” sound, if the jets don’t work or if the jets only work in part of the spa when you press the jets button, it is likely you have an air lock and need to bleed the pump. To bleed air from the pump, manually turn the GFCI “off” and with a flat head screw driver, turn the bleed valve (thumb screw) on the base of the pump counter clockwise until water trickles from the pump. When water begins to trickle, turn the bleed valve clockwise to tighten. Do not over tighten. Do not use a wrench or vice grips to turn the bleed valve because it may break the thumb screw.



Getting to Know Your Spa

The Slice Valves (“T” Stems) allow service without draining the all of the water from the spa. Slice valves or “T” stems are installed in the plumbing lines near the pump(s) Pushing the “T” stem down creates a seal between the “T” stems. When service is complete, the “T” stems are raised and locked in the up position. Slice valves must be locked in the “up” position before power is applied to the spa. If the spa is turned on and the slice valves are closed it can damage the spa immediately. Each time you change the water in the spa, you should check to be sure the locks on the slice valves are in good condition; locks should be replaced if they will not hold the “T”stem in the “up” position. Do not use the spa until the locks have been replaced.

The Plumbing Unions connect the plumbing lines to the spa components. Unions can become loose in transit and when seasons change. During the initial installation and each time you drain your spa, you should hand tighten all plumbing unions. The main cause of leaks inside the spa cabinet is plumbing unions that need to be tightened. Do not use tools or overtighten plumbing unions

The Filter Assembly consists of the filter, the filter basket and the weir. The filter basket catches large debris, the filter catches fine particulates and oil. You should check the filter assembly on a regular basis making sure the basket is free of debris and the filter is in good condition. If the filter assembly is obstructed, flow will be restricted which can damage the spa. Using the spa without the filter assembly in place is a drowning hazard and may damage the spa. If any part of the filter assembly is damaged, do not use the spa until it has been replaced. Please call technical service at 844-894-6659 for replacement parts. Before removing the filter assembly to fill the spa or change the filter, manually power the GFCI “OFF”. Turn the weir counter clockwise until it stops. Lift the weir, raise and remove the basket. Lift the filter from filter housing. Replace the filter, basket and weir. Turn the weir assembly clockwise until it stops and is locked in place. The manufacturer recommends that you replace the filter every three months. To prevent air in the plumbing lines, you should soak new filters in water for 30 minutes before installing.

The Suction Drain Covers are on the sides in the foot well of the spa. They are caps that cover the suction drains to help prevent risk of drowning and debris from being sucked into the plumbing lines. If the suction drain covers are obstructed, flow is restricted which can damage your spa. Keep hair, clothing and children away from the suction drains when using the spa. It is important to check them on a regular basis making sure they are good condition Do not use the spa if they need to be replaced. Replacement parts can be obtained



Getting to Know Your Spa

by technical service at 844-894-6659. You should avoid contact with the suction drain covers when the GFCI is powered “on”. *The Diverter Valve is a large rotating dial on top of the acrylic surface that controls the flow of water in seating areas serviced by the same pump. When the diverter valve is positioned in the center, water flow will be spread evenly throughout each seat sharing that pump. Turning the diverter valve all the way to one side will restrict the water flow from one section and force all of the flow into the other section. Turning the diverter valve all the way to the other side will reverse the flow of water to the opposite side of the spa.*



DIFFICULTY ROTATING DIVERTER VALVES



When the jets are turned on, excessive pressure in the plumbing lines makes rotating the diverter valves difficult. Turn the jets off and rotate the diverter valve back and forth, then turn the jets back on. Do not force the diverter valve past the natural stopping point. Forcing the valve to turn past its built in “stop” or when there is excessive pressure in the lines will damage the spa.

The Air Valve is a small rotating dial on the acrylic surface that looks like a smaller diverter valve that increases or decreases air flow through the jets. Increasing air flow creates “bubble action” in the spa. When the air valve is positioned in the center, there is moderate air flow with moderate “bubble action”. When the air valve is turned to one direction, or closed, there is less air flow and fewer bubbles. If the air valve is turned fully to the opposite direction, the air valve is fully open creating the most bubbles. The air valve rotates right and left. Do not over turn the air valve which has built in “stops”. Forcing the valve to turn past its built in “stop” will damage the spa.

The Waterfall Valve is used to increase or decrease flow thru the waterfall. The waterfall valve rotates right and left. When the waterfall valve is placed in the center, there is moderate flow through the waterfall. If the valve is turned all the way in one direction, there is no flow through the waterfall. If the valve is turned all the way in the opposite direction, the flow is increased to allow maximum flow through the waterfall.



DIFFICULTY ROTATING WATERFALL VALVES



When the jets are turned on, excessive pressure in the plumbing lines makes it difficult to rotate the waterfall valve. Turn the jets off and rotate the waterfall valve back and forth, then turn the jets back on. Do not over turn the waterfall valve which has built in “stops”. Forcing the valve to turn past its built in “stop” will damage the spa.

Maintaining Water Quality

The Importance of Good Water Chemistry

For your health and safety, it is imperative to have clean, clear, water. Water maintenance will vary depending on many things like the base water quality, how often the spa is used and how many people use the spa. Remember, when it comes to water chemistry, filtration is not the same as sanitation. Following a regular schedule will help you achieve and maintain good water chemistry. Bacteria and viruses grow quickly in water when it is not properly maintained. Maintaining your water is necessary not only for proper sanitation, but preventing buildup and deposits that will harm your spa.

One of the leading preventable causes of spa malfunction is failure to maintain good water chemistry. Too many chemicals may cause deterioration of the components, acrylic surface and the spa cover. Not enough sanitation allows impurities to accumulate, which will hinder performance and may cause permanent damage to the spa. Water can become unsanitary very quickly if chemicals are not used to adequately sanitize. Incorrect pH or calcium levels can lead to corrosion and scale build up on integral spa components.

The following guidelines have been established for spas by the Association of Pool and Spa Professionals:

pH	7.2 to 7.6
Free Chlorine	3.0 to 4.0 ppm
Free Bromine	2.0 to 4.0 ppm
Total Alkalinity	80 to 120 ppm
Calcium Hardness	150 to 250 ppm



Maintaining Water Quality

Common Sense Water Chemistry

Without chemicals, the warm water in your spa is the perfect environment for germs, bacteria and other living organisms. Chemicals added to your spa water are utilized as they destroy the bacteria from dead skin cells, sweat and other bodily fluids. Routine addition of sanitizers kept at constant levels keep your water clean and safe to use. Maintaining water chemistry is different in every spa and for every spa user. Your water chemistry changes constantly. When the water in your spa evaporates, dissolved solids like calcium, salt and metal remain, they do not evaporate with the water. Adding more water adds more dissolved solids which may leave deposits on the acrylic surface and inside the spa components. When the cover is off, pollen, dust and dirt change the water chemistry. A spa once a day will require more chemicals than the same spa filled with water from the same source that's only used once a week. What it takes to balance your water chemistry in January will be different in July.

The major considerations in water chemistry are:

- The number of gallons of water in the spa
- The number of people using the spa
- The number of hours the spa is being used

In short, more water used by more people for longer periods will require more chemicals.

Whether you have used your spa or not, you should test your water twice a week. Regular testing lets you to make adjustments before your water chemistry is out of control. When it comes to chemicals, more is not better. Adding chemicals changes the pH. Fluctuations in the pH change the way chemicals react. The addition of too many chemicals may mean your only option is to drain the spa and start over. Depending on how many people use the spa and how often the spa is used, you should replace the water every four to six months to ensure your comfort and safety. Replacing the water will also help protect the spa components from damage caused by dissolved solids that build up over time.



Maintaining Water Quality

Ozone Generators

Your spa may have come with an ozone generator which will help reduce dissolved solids and increase oxygen in the water, but it will not sanitize the water without chemicals. You must use a sanitizer in tandem with the ozone generator. The ozone generator is designed to make chemicals more efficient and maintaining good water chemistry easier.

Chlorine Generators

Your spa may have come with an optional salt system, also known as a chlorine generator. This system is designed to maintain water chemistry by converting salt into sanitizer without using any chemicals. Since the system does not create any residual chlorine, water testing will not provide an accurate assessment of sanitation levels. Test strips are only used to test and maintain adequate levels of alkalinity, pH and water hardness when you have a chlorine generator.

Breaking Down the Basics

Each step of a water maintenance program is dependent upon the previous steps. Omission of any step or failing to reach the recommended ranges may cause an imbalance in water chemistry. Unbalanced water may cause damage to the spa components and create discomfort for bathers. To measure the quality of your water, immerse a test strip in water following the instructions on the container. Do not touch the test strips as it may affect the results. Compare the test strip and the label to determine the condition of the spa water.

Step 1.) Balancing Total Alkalinity (TA)

The recommended total alkalinity levels are between 80 and 120 ppm. The Total Alkalinity is the measurement of carbonates, bicarbonates, hydroxides and other alkaline substances in the water. TA is referred to as the water's "pH buffer". It is a measure of the water's ability to resist changes in the pH level. If the TA is too low, the pH level will fluctuate quickly, easily and greatly. Changes in pH can cause corrosion or scaling on the spa components. You can correct low Total Alkalinity by adding sodium hydrogen carbonate (pH/Alkalinity Up).

Step 2.) Balancing Calcium Hardness (CH)

The recommended calcium hardness (CH) level for your spa is 150-250 ppm. Calcium Hardness is a measurement of the total amount of dissolved calcium in the water. Calcium helps control the corrosive nature of the spa's water. Calcium-low water (commonly known



Maintaining Water Quality

as “soft” water) is not recommended. It is highly corrosive to the components and can stain the acrylic surface. If the CH is too high (commonly known as “hard” water), formation of scale on the spa and the components can result. CH can be decreased by using a mixture of 75% “hard” water and 25% “soft” water; this will usually yield a reading of the correct range. If “soft” water is not available or practical for you, a stain and scale inhibitor should be added to the water according to the label instructions. If CH is too low, add a CH increaser. Once the CH is balanced, it normally remains stable. Adding small quantities of water should not change the CH level. When the Calcium Hardness is within recommended range, proceed to the next step.

Step 3.) Balancing the pH

The pH level is the measure of the acidity and the alkalinity. It is imperative to have a slightly alkaline pH level between 7.2 and 7.6. Problems become proportionately more severe the further outside this range the water gets. Values above 7 are alkaline; those below 7 are acidic. Maintaining proper pH level is extremely important for optimizing the effectiveness of sanitizer, maintaining water comfort for the users, and prevention of equipment deterioration. If the pH level in the water is too low, the sanitizer will dissipate rapidly, the water may become irritating to users, and the spa equipment may corrode. If the pH is too low, it can be increased by adding sodium hydrogen carbonate (pH/Alkalinity Up) to the spa water. If the pH level is too high, the sanitizer is less effective, scale may form on the spa and the spa components, the water may become cloudy and pores in the filter cartridge will become clogged and obstructed. If the pH is too high, it can be decreased by adding sodium bisulfate (pH/Alkalinity Down) to the spa water. Wait two hours after adding sodium hydrogen carbonate or sodium bisulfate before testing the pH levels again. It is important to check the pH level on a weekly basis. The pH will be affected by the bather load, the addition of new water, the addition of chemicals and the type of sanitizer used. When the pH is within the recommended range, proceed to the final step.

Step 4.) Maintaining the Sanitizer Levels

Sanitizer is extremely important. It kills algae, bacteria and viruses while preventing unwanted organisms from growing in the spa. At the same time, if the sanitizer levels are too high it may cause irritation to the skin, lungs and eyes. Always maintain the sanitizer level in your spa at the recommended levels specified for each type of sanitizer. You should check the your sanitizer and pH levels before each use and at least twice each week even if the spa is not in use.



Maintaining Water Quality



WARNING!

Risk of Chemical Reaction and Noxious Fumes

Handle Spa Chemicals with Care

Never pre mix dry chemicals

Always follow instructions on the label

High levels of sanitizer can cause discomfort to eyes, lungs and skin.

Never enter the spa if chemical levels exceed the recommendations.

Adding Chemicals

The water temperature must be at least 80°F before adding chemicals to prevent damage to the acrylic surface. Always wear safety goggles and gloves to prevent injury. Remove the cover. Fill a large bucket (minimum 2 gallon capacity)with warm water from the spa. Use care not to splash chemicals onto the spa cabinet, or the acrylic surface of the spa. Carefully measure the recommended amount of each chemical, one at a time, following the instructions on the label. Replace the lid on the chemical container. Thoroughly mix the chemical with the bucket of warm water from the spa. Remove the filter basket assembly and filter. Press the Primary Pump button to turn the pump on high speed. With the pump running on high speed, being careful not to get too close, add warm water and chemical mixture into the filtration canister. Repeat this procedure with each chemical you add. When all chemicals have been added and with the cover off the spa, run the pumps on high speed for ten minutes. After 10 minutes, reduce the pump speed to low for one full cycle. When the jet cycle is complete, replace the filter and the filter assembly. Replace and lock the cover. Never leave the spa unattended when the cover is off.

Do not use tri-chlor chlorine, bromo-chlor-dimethyl-hydantoin (BCDMH) or any type of compressed bromine or chlorine, acid or any sanitizer not recommended Dr. Wellness Spa.

Heavy Cleaning or Decontamination

On occasion, it may be necessary to “Super Sanitize” your spa. If algae develops, simply replacing the filter, draining and refilling the spa will not kill the algae. It will be necessary for you to decontaminate the spa before it can be used safely.



Maintaining Water Quality



Warning!

Risk of Chemical Reaction and Noxious Fumes

During the decontamination process, excessive chemical vapors are produced.

Wear gloves and a protective mask during the decontamination process.

Keep children and pets away from the spa.

Remove the spa cover, all pillows and cover the plastic valves to protect them.

If your spa is indoors, open the windows and doors. Use a fan to circulate the air and force the vapors out of the room.



Step by Step Instructions to Decontaminate your Spa



1. Remove the filter basket assembly, filter and spa pillows. Before adding chemicals, make sure all pumps are operable. Check to be sure all jets and air valves are open. Be certain the diverter valves covered to protect them from splashes and are in the center position allowing even circulation throughout the entire spa.
2. Turn all pumps on low speed. In a large bucket (minimum 2 gallon capacity) filled with warm water, carefully add 2.5 ounces of sodium dichlor for every 100 gallons of water in the spa and mix thoroughly in the bucket. For example, if there are 400 gallons of water in your spa, add 10 ounces of sodium dichlor to the large bucket filled with warm water. Turn all of the pumps on low speed. Gently pour the warm water and chemical mixture into the filter housing. After all of the sodium dichlor mixture has been added, turn all pumps on their highest speed and allow the water to circulate for one hour. Do not replace the cover over the spa during decontamination. Never leave the spa unattended while it is uncovered.
3. After the spa has been allowed to run for one hour, turn off all of the pumps and manually turn the GFCI "off". Drain the spa. Follow the steps to fill the spa and remember to put a new filter in the foot well of the spa allowing it to saturate as the spa fills with water. Add chemicals as needed to maintain proper water chemistry.



Maintaining Water Quality

Filter Care and Replacement

The filter catches debris that is too small for the filter basket, like hair, lotion and body oil. A dirty filter means dirty water. Filters are made of compressed fibers that decompress over time. After the fibers break down and become saturated with dirt and oil allowing contaminants and debris to enter the spa, causing unnecessary strain on the pumps and damaging the components. You should have to have a supply of replacement filters on hand, in addition to chemicals used to maintain your water. Extra filters are affordable, can be delivered to your home and purchased at www.dr-wellness.com. Your filter needs to be cleaned or replaced when:

- You notice reduced flow from the jets
- The water is hazy, cloudy or discolored
- The heater is running more frequently but the water is not heating evenly or normally

Cleaning your filter

Your filters should be cleaned every two to four weeks, depending on use. Manually turn the GFCI “off”. Following the steps to remove the filter assembly, remove the filter. With a garden hose equipped with a high pressure spray nozzle, rinse the filter making sure to spray between each pleat.

Deep Cleaning your Filter

Filter cleaners may help remove some collected dirt, lotion and body oils that rinsing won't remove. Following the instructions on the bottle of filter cleaner, carefully place the filter in the cleaning solution. Let the filter soak in the solution following the instructions on the cleaner label. Remove the filter and thoroughly rinse making sure to spray between each pleat. Allow the filter to dry completely. When the filter is dry, brush between each pleat with a fine hair brush. After brushing between the pleats, place the filter in a bucket filled with water or in the spa until the filter is saturated. Replace the filter and reassemble the filter assembly.

- Never use a wire brush on the filter.
- Never put your filter in the dishwasher.
- Never put a dry filter in the filter housing.

Replacement Filter Cartridges

Deep cleaning dirty filters is time consuming, requires the use of additional chemicals and may not remove all residual dirt, body oil and bacteria if not done properly. Depending on use and bather load, Dr. Wellness recommends that you replace your filters every 3 months.



Maintaining Water Quality



Handling Spa Chemicals



- Wash your hands after handling chemicals. In case of accidental contact, follow the emergency advice on the product label. If a doctor is needed, take chemical containers with you to the hospital so the substances can be identified.
- Clean up spilled chemicals immediately using water from a water hose. Saturate the surrounding area thoroughly, especially areas used by children and pets to ensure safety.
- Keep chemicals in their original container with the lid replaced properly after using. Keep containers closed when not in use.
- Keep chemicals away from children and pets. Allow a responsible person to handle spa chemicals; use care when handling chemicals.
- Store chemicals in a cool, dry, well ventilated place.
- Follow local laws when disposing of the water in your spa.
- Never allow the water drained from your spa to run into public water sources.
- Add chemicals when the water temperature is 80°F or higher
- Never smoke when handling chemicals. Some of the chemicals are highly flammable and smoking can lead to serious injury.
- Do not store chemicals in the spa cabinet
- Never expose spa chemicals to extreme temperatures or bright light.
- Do not allow anyone in the spa while adding chemicals. Inhaling fumes or contact with your eyes, nose or mouth is very dangerous.
- Never use swimming pool chemicals, muriatic acid or household bleach, or chlorine tablets (trichlor) in your spa. It can be extremely corrosive. Damage caused by use of tri-chlor is not covered under the manufacturer's warranty.
- Never use a vacuum cleaner to clean up chemical spills
- Immediately remove chemical spills from surrounding surfaces and landscaping.



Maintaining Water Quality

TROUBLESHOOTING WATER CHEMISTRY

Problem	Could be Caused By	Could be Solved By
Water Will Not Balance	Well, Untreated Municipal or Softened Water	<i>SEEK LOCAL PROFESSIONAL ASSISTANCE.</i> The manufacturer does not recommend filling the spa with well, untreated or softened water.
Cloudy Water	Dirty Filter Excessive Organic Matter Bacteria on Cover Dripping into Spa Improper Sanitization Suspended Organic Matter End of Water Life	Replace Filter Add Shock Clean Cover with Approved Cleaner Add Sanitizer Clean or Replace Filter, Add Shock, Run Jets Drain & Refill Spa, Replace Filter
Green or Brown Water	Excessive Metal	Add Metal Sequestering Agent
Excessive Foam	Accumulation of oil, cosmetics and detergent	Add Defoamer Clean or replace filter Run extra rinse cycle when washing swim wear
Water has Bad Smell	Excessive Organic Matter - Bacteria Growth Improperly Sanitized Low pH	Add Shock Add Sanitizer Adjust pH



Maintaining Water Quality

TROUBLESHOOTING WATER CHEMISTRY

Problem	Could be Caused By	Could be Solved By
Smells Musty	Bacteria Growth	Add Shock. If the problem persists, perform Spa Decontamination
Ring Around Spa	Build Up of Oil & Dirt	Wipe surface with cloth, drain and refill spa.
Algae	High pH	Add pH Reducer
	Low Sanitizer Level	Add Shock & Sanitizer
Eye or Skin Irritation and/or Rash	Improper Sanitation	Test Water. Add Shock & Sanitizer as Needed
	Free Chlorine too High	Add Water Causing Sanitizer Levels to Drop
	Dirty Filter	Clean or Replace Filter
Stains on Acrylic Surface	High Alkalinity or Low pH	Adjust Alkalinity and pH Accordingly
	High Mineral Content	Use Stain & Scale Reducer
	High Metal Content	Use Metal Sequestering Agent
Scale Build Up	High Calcium Levels	Adjust Alkalinity; Use Stain & Scale Reducer



General Care and Maintenance

Your Dr. Wellness spa was manufactured with the highest quality of materials and care available in the spa industry making sure you spend more time enjoying your spa than you do taking care of it. Just as a healthy body requires an occasional check up, a healthy spa requires some maintenance and attention. Developing a regular routine of care ensures your spa's health and your peace of mind.

Caring for the Acrylic Surface

Your spa was cast from Lucite® Acrylic making it durable and resilient. It is dirt and stain resistant. Using household cleaners and detergent may leave a dulling residue. When needed, wipe the surface with warm water and a soft cloth. Never use abrasive, ammonia or citrus based cleaners because they will damage the acrylic. Chemicals in some cleaners may have react negatively with the chemicals used to maintain water chemistry.

Caring for the Cabinet Panels

Your spa cabinet is water and weather resistant. It is virtually maintenance free. You will never need to wax, paint or seal the cabinet. When necessary, rinse the cabinet with water from a water hose equipped with a moderate pressure nozzle. More stubborn dirt can be removed by rubbing with a damp, soft cloth. Never use abrasive cleaners or a high pressure hose which may scar the cabinet.

Caring for the Pillows

The pillows in your spa are covered in water resistant vinyl. To prevent discoloration, they should be wiped off periodically to remove chemical residue and treated with a non-alcohol based vinyl protector. Many vinyl protectors are oil based and should be avoided. Using oil based products will adversely affect water clarity and chemistry which can be difficult to correct. If you are not using your spa for a prolonged period, pillows should be removed from the spa, dried off and stored. If the vinyl is punctured and the foam is exposed they should be replaced. Replacement pillows are available. Please call a technical support representative at 844-894-6659.

Caring for the Jets

Most of the jets are interchangeable with other jets that are the same size and can be turned on and off by rotating the outside of the jet. It's a good idea to leave all of the jets open to prevent damage that can occur when excessive pressure builds in the plumbing lines. When jets become difficult to rotate, they should be cleaned. With the GFCI in the "off" position, rotate each jet counter clockwise until it reaches its built in "stop" and gently pull the jet outward, removing it from the jet housing. Place all of the jets in a bucket filled with white



General Care and Maintenance

vinegar overnight. Rinse with warm water. Stubborn dirt on the white part of the jet body can be removed with a soft bristle brush. Do not use steel wool or a wire brush. You should clean your jets each time you drain your spa. If the white jet body on the back of the jet is damaged it should be replaced. Replacement jets are available by calling a technical support representative at 844-894-6659.

Caring for the Lights

The lense cover over the underwater light is permanently installed. Do not attempt to remove the lense cover. When the spa has been drained, wipe the light lense with a cloth designed for cleaning eyewear to prevent scratching the lense cover. If the other side of the large underwater light is also dirty, remove the cabinet panel, remove the bulb from the lamp holder and wipe with a cleaner and cloth designed for cleaning eyewear. Replace the bulb. Make sure the bulb was properly replaced and the light works before reinstalling the cabinet panel. If you need a replacement bulb, please call a technical support representative at 844-894-6659.

Do not attempt to clean the back sides of the perimeter lighting lense covers.

Caring for Audio/Video Systems

If your spa is equipped with an audio or video system, you will hear your selection from the built in speakers. You should wipe chemical residue from the speaker covers with a soft cloth to prevent discoloration. The sub-woofer is enclosed in the spa cabinet and does not require routine maintenance. The built in audio/video components and docking station compartment should be cleaned with a soft, dry cloth. While you are outside the spa, place your selection in the player, push play, and select the volume from the device. Before you enter the spa, plug in your MP3 player and place it in the docking station. Close the docking station door for your safety and to protect your device.

Never place your MP3 player or other electronic devices on the side of the spa.

Never handle audio/video devices while inside the spa.

Never use headphones in the spa.

Caring for the Spa Cover

The foam cores in your spa cover are designed to protect your spa from the elements, reduce heat loss, keep unwanted debris out of the spa, and to prevent evaporation. You should clean the vinyl with a small amount of mild dish soap diluted in warm water and



General Care and Maintenance

a soft sponge 3 or 4 times a year. Allow to dry and wipe with an oil free, non-alcohol based vinyl protector. Many vinyl protectors are oil based and should be avoided. Using oil based products will adversely affect water clarity and chemistry which can be difficult to correct. Using alcohol or chlorine based cleaning products will cause the stitching to deteriorate and damage the UV inhibitors built into the vinyl. The locking tie downs are not designed to keep the cover in place in heavy winds. You should consider using wind straps to stabilize the cover and protect the spa. Use the handles to remove and replace the cover. The cover is sturdy but should never be dragged and is not designed to hold heavy weight loads. Heavy snow loads should be brushed off with a clean soft bristle broom. Never stand on or allow children or pets on the spa cover. When the spa is not in use, the cover should be in place with the tie downs.

Caring for the spa in cold weather

Your spa is well insulated to make it economical to operate even in the coldest climate. As long as it is filled with water and power is supplied, the spa will function in January just as it did in July. Keeping your spa fully operational at all times is the best protection. We do not recommend draining your spa and disconnecting the power supply in the winter. If you live in an extremely cold climate or an area where power outages are common and the spa is subjected to freezing temperatures, we encourage you to hire a professional to winterize your spa safely. The standard of practice varies by location. All of the water must be removed from the filter housing, pumps, heater, jets and plumbing lines. Simply draining the water as you would for normal maintenance will not provide adequate protection from freezing. Damage that occurs if the spa freezes is not covered under the warranty.

If you experience system failure and the spa is exposed to freezing temperatures, manually turn the GFCI “off” for 30 minutes then turn the GFCI “on”. The system may reset and function normally. If that fails, call a technical support representative immediately at 844-894-6659. If the system failure occurs after hours, and your pumps will not circulate the water, you should place a low wattage space heater inside the cabinet near the spa equipment to help prevent freezing. To avoid the risk of fire or injury, do not leave the spa unattended when the heater is inside the cabinet. If you leave home, turn the heater off.



SPA TROUBLESHOOTING GUIDE

THE FIRST STEP IN THE TROUBLESHOOTING PROCESS IS TO CHECK THE TOPSIDE CONTROLS FOR DIAGNOSTIC MESSAGES.

If you do not see the solution to your problem , please call a technical support associate at 844-894-6659 for assistance.

WHEN MAKING REPAIRS TO YOUR SPA, YOU SHOULD ALWAYS MANUALLY TURN THE GFCI “OFF” TO ELIMINATE RISK OF SHOCK.

Problem	May be Caused By	Might Be Solved By
LED Display is blank	Power is off or fuse is blown	Reset GFCI and Main Service. Replace blown fuses
Spa Will Not Power Off	Spa is heating Spa is filtering	Lower temperature settings Normal function of spa
Spa Leaking	Loose unions	Hand tighten unions
GFCI Tripping	Improper wiring	Get Electrician to check neutral wiring connections at GFCI
Pump(s) Not Working	Air Lock Pump Cycle has ended Slice Valves Closed No Power Blockage in line	Bleed the pump(s) Press button to turn pump on Open Slice Valves Check pump connection in spa control box Clear obstructions in filter assemblies
Pump(s) run hot	Pump running dry Flow restricted	Call technical support at 844-894-6659 Remove debris from filter basket and suction valves.
Pump Surges	Water level too low Blockage or restriction	Add water Empty filter basket and clean suction drain covers



SPA TROUBLESHOOTING GUIDE

THE FIRST STEP IN THE TROUBLESHOOTING PROCESS IS TO CHECK THE TOPSIDE CONTROLS FOR DIAGNOSTIC MESSAGES.

If you do not see the solution to your problem , please call a technical support associate at 844-894-6659 for assistance.

WHEN MAKING REPAIRS TO YOUR SPA, YOU SHOULD ALWAYS MANUALLY TURN THE GFCI "OFF" TO ELIMINATE RISK OF SHOCK.

Problem	May be Caused By	Might Be Solved By
No or Low Heat	Spa is at correct temperature Operating Mode Temperature Setting Breaker(s) off Dirty Filter Air Lock or Closed Slice Valve Improper Line Voltage	Normal function of spa Check to be sure the spa is not in Economy Mode Check LED display to see if Heater Icon is illuminated Reset GFCI and Main Breaker Change filter Make sure slice valves are open and pumps are not air locked Have an electrician check voltage
Heats, but not High Enough	Thermostat turned down Dirty filter Slice valve closed Spa cover shifted	Increase temperature setting Change filter Open slice valves Reposition spa cover
Over Heat Message on LED	Filtration settings Outside temperature high to allow cooling	Reduce number and duration of filtration cycles Temporarily remove cover and/or add cold water



SPA TROUBLESHOOTING GUIDE

THE FIRST STEP IN THE TROUBLESHOOTING PROCESS IS TO CHECK THE TOPSIDE CONTROLS FOR DIAGNOSTIC MESSAGES.

If you do not see the solution to your problem , please call a technical support associate at 844-894-6659 for assistance.

WHEN MAKING REPAIRS TO YOUR SPA, YOU SHOULD ALWAYS MANUALLY TURN THE GFCI “OFF” TO ELIMINATE RISK OF SHOCK.

Problem	May be Caused By	Might Be Solved By
Lights Don't Work	Bulb or fuse burned out Loose, dirty connection	Replace bulb or fuse Check light connections
Jets Don't Work	Air lock in pump(s) Slice valve(s) closed Diverter valve closed Jet Closed Dirty Filter	Bleed pump(s) Open slice valves Rotate diverter until desired pressure is achieved Rotate outer rim of jet clockwise to open Change filter
Low Water Flow	Spa heating or filtering Diverter valve position Air valve closed Dirty filter Slice valve(s) closed Improper Line Voltage	Normal spa function Rotate diverter valve to increase flow Rotate air valve to open Clean or replace filter Open slice valves Have an electrician check voltage



Manufacturer's Limited Warranty

Spa Warranty Policies and Procedures

Important Notice: The following are not actual warranties, but detailed descriptions of our warranty policies and procedures. Certain exclusions and disclaimers may apply to these descriptions. Be sure you read and understand the spa warranty. These policies and procedures are subject to change at any time and without notice. Throughout this document, Dr. Wellness Spas shall be referred to as the "MANUFACTURER". Each spa warranty is given to the original consumer only and terminates upon transfer of ownership. Any commercial applications are excluded from all warranties.

Labor Warranty

Labor is described as the work completed by a technician. MANUFACTURER will be responsible for the costs associated for labor for all warranty repairs for ninety (90) days from the original date of purchase. THIS WARRANTY IS GIVEN TO THE ORIGINAL CONSUMER AND TERMINATES UPON TRANSFER OF OWNERSHIP. COMMERCIAL APPLICATIONS ARE EXCLUDED FROM THIS WARRANTY. It is the responsibility of the spa owner to ensure that the spa is accessible for repairs. MANUFACTURER is not responsible for any cost associated with making spa accessible for repairs. If parts are required for repair, MANUFACTURER is not responsible for the cost of shipping of parts under the terms of this warranty agreement.

Warranty Procedures

THE DR. WELLNESS SPAS WILL WORK WITH YOUR DEALER TOWARD RESOLVING YOUR WARRANTY REQUEST AS QUICKLY AS POSSIBLE. TO ENSURE THE EFFICIENT PROCESSING OF YOUR WARRANTY CLAIM, PLEASE FOLLOW THESE STEPS:

1. The MANUFACTURER relies upon the consumer and service technician to assist in warranty claims and how best to work toward the consumer's satisfaction. If you have any questions concerning a claim, you should call your local dealer for assistance.
2. If the claim is determined to be valid you will need to submit to Dr. Wellness Spas the proof of purchase, photographs of the spa, wiring configurations, components and the surrounding area where the spa is supported. Dr. Wellness Spas will determine the proper solution for repairing the spa. Warranty requests must include the following information:

* Spa Model
* Date of Delivery
* Dealer Name

* Name & Address of Customer* Spa Serial Number
* Date of Purchase
* Photographs of the area of concern

* Phone number of Customer
* Date of Installation
* Thorough Description Problem

MOST OF THIS INFORMATION IS ON THE ORIGINAL PURCHASE INVOICE.



For technical support and assistance, call 844-894-6659

Manufacturer's Limited Warranty

3. Upon receipt of all of the requested information, Dr. Wellness Spas will evaluate it and decide how the claim will be resolved. Repair or replacement is at the MANUFACTURER'S discretion. In all situations, a repair is considered the appropriate course of action. If the spa cannot be repaired in the field and must be returned to the factory, approval must be obtained from Dr. Wellness Spas. Cost for removal of the defective spa, delivery and installation of the replacement spa are the responsibility of the consumer and will not under any circumstances be covered by the MANUFACTURER. It is the responsibility of the spa owner to ensure that the spa is accessible for repairs. MANUFACTURER is not responsible for any cost associated with making spa accessible for repairs. If parts are required for repair, MANUFACTURER is not responsible for the cost of shipping of parts under the terms of this warranty agreement.
4. Partial documentation submissions will not be considered and do not constitute filing a warranty claim. MANUFACTURER is not responsible for delays caused by failure to submit all of the information in a timely manner.

Surface Warranty

The spa surface is defined as the exposed material finish. The MANUFACTURER warrants the spa surface to be free from defects in material and workmanship, such as blistering, cracking, or delamination, under normal use and maintenance for a period of five (5) years from the original date of purchase.

The spa must be placed on a level concrete slab sufficiently engineered to support the entire length and width of the spa when filled to capacity. Standard building practices must be followed. Damage caused by failure to have a properly leveled and supported foundation under the spa is not covered under warranty. The MANUFACTURER does not warrant against problems associated with prolonged standing water, prolonged exposure to sunlight and/or use of any sanitation or ozone system not approved by the MANUFACTURER. Damage to the spa surface caused by leaving the spa uncovered and/or empty of water with direct exposure to sunlight will terminate this warranty. Any alteration to any system, including but not limited to electrical, plumbing, or mechanical, improper water chemistry, or any other problems caused by any external source are not covered under warranty. Other exclusions may apply.

Normally, problems associated with material and workmanship can and will be repaired. If the spa surface is repaired, the repair is limited to the affected area only, and there is no guarantee against discoloration or fading. The decision to repair will be made by the MANUFACTURER and its field representative after review of the facts, pictures, or any other data presented by the dealer or the



Manufacturer's Limited Warranty

customer. In all cases, pictures of the affected area and foundation of the spa must be provided before any decisions to repair or replace will be made. In the unlikely event a spa is replaced, all warranties (including but not limited to shell, acrylic, equipment and plumbing) date back to the original date of purchase. If it is determined that the shell is to be replaced, the same conditions and terms as outlined in the shell warranty section apply. It is the responsibility of the spa owner to ensure that the spa is accessible for repairs. MANUFACTURER is not responsible for any cost associated with making spa accessible for repairs. If parts are required for repair, MANUFACTURER is not responsible for the cost of shipping of parts under the terms of this warranty agreement.

Structural Frame Support Warranty

The spa structure and frame are defined as the exposed material finish. The MANUFACTURER warrants the framing structural support to be free from defects in material and workmanship under normal use and maintenance for a period of five (5) years from the original date of purchase.

Damages to the spa structure and frame, including but not limited to dry rot that occurs as the result of failure to reinstall or replace damaged cabinet, wet rot that occurs as the result of prolonged exposure to standing water, damage that occurs as the result of relocation after initial installation, insect or rodent damage, neglect, misuse, abuse, improper care or maintenance, or Act of God will not be covered under this warranty. This is not an all inclusive list. The spa must be placed on a level concrete slab sufficiently engineered to support the entire length and width of the spa when filled to capacity. Standard building practices must be followed. Damage caused by failure to have a properly leveled and supported foundation under the spa is not covered under warranty. Any alteration or any other problems caused by any external source are not covered under warranty.

Normally, problems associated with material and workmanship can and will be repaired. If the spa structure and frame are repaired, the repair is limited to the affected area only. The decision to repair will be made by the MANUFACTURER and its field representative after review of the facts, pictures, or any other data presented by the dealer or the customer. In all cases, pictures of the affected area and foundation of the spa must be provided before any decisions to repair or replace will be made. In the unlikely event a spa is replaced, all warranties (including but not limited to shell, acrylic, equipment and plumbing) date back to the original date of purchase. If it is determined that the structural frame is to be replaced, the same conditions and terms as outlined in the structural frame warranty section apply. It is the responsibility of the spa owner to ensure that the spa is accessible for repairs. MANUFACTURER is not responsible for any cost associated with making spa accessible for repairs. If parts are required for repair, MANUFACTURER is not responsible for the cost of shipping of parts under the terms of this warranty agreement.



Manufacturer's Limited Warranty

Components Warranty

The components may be defined as the electrical items (i.e, pumps, equipment packs, heaters, topside, etc.) The MANUFACTURER warrants all components to be free from defect in material and workmanship for two (2) years. THIS WARRANTY IS GIVEN TO THE ORIGINAL CONSUMER ONLY AND TERMINATES UPON TRANSFER OF OWNERSHIP. COMMERCIAL APPLICATIONS ARE EXCLUDED FROM THIS WARRANTY.

Some components including, but not limited to, the spa cover, ozonator, salt system, jet faces, skirting, and pillows are warranted to be free from defects in materials and workmanship for one (1) year. Audio and video components, speakers and related parts, are warranted to be free from defects in materials and workmanship for ninety (90) days. Some items, including, but not limited to pump seals are a maintenance item and are covered for manufacturing defects only. Damage caused by weather, poor water chemistry, standing water and/or improper maintenance will not be covered under this warranty. Alterations or replacement of components installed in the spa that are not purchased and/or approved by the MANUFACTURER will terminate the spa warranty.

It is the responsibility of the spa owner to ensure that the spa is accessible for repairs. MANUFACTURER is not responsible for any cost associated with making spa accessible for repairs. If parts are required for repair, MANUFACTURER is not responsible for the cost of shipping of parts under the terms of this warranty agreement.

Plumbing Warranty

The plumbing may include all piping, jets and valves. The MANUFACTURER warrants all plumbing parts to be free from defect in material and workmanship for two (2) years.

THIS WARRANTY IS GIVEN TO THE ORIGINAL CONSUMER ONLY AND TERMINATES UPON TRANSFER OF OWNERSHIP. COMMERCIAL APPLICATIONS ARE EXCLUDED FROM THIS WARRANTY. Jet internals, valve and diverter handles are not covered under this warranty. Damage caused by weather, poor water chemistry, standing water, and/or improper maintenance will not be covered under this warranty. It is the responsibility of the spa owner to insure that the spa is accessible for repairs. MANUFACTURER is not responsible for any cost associated with making spa accessible for repairs. If parts are required for repair, MANUFACTURER is not responsible for the cost of shipping of parts under the terms of this warranty agreement.



Manufacturer's Limited Warranty

Components and Plumbing Warranty Procedures

DR. WELLNESS SPAS AND YOUR LOCAL DEALER WILL WORK WITH YOU TO MAKE THE PROCESS AS EASY AS POSSIBLE. TO ENSURE FAST & EFFICIENT PROCESSING OF COMPONENTS AND PLUMBING CLAIMS, PLEASE FOLLOW THESE STEPS:

1. Your local dealer & Dr. Wellness Spas must determine whether or not damage is due to manufacturer's defect. If the damage is due to manufacturer's defect, the MANUFACTURER will warrant the defective part during the warranty period. This does not include any travel or trip charges, troubleshooting or diagnostic charges. Customers living outside the technician's travel area need to be aware that trip charges are their responsibility.

2. Dr. Wellness Spas will troubleshoot the problem and supply necessary parts for repair. The authorized technician will repair the problem. If the technician has a problem with a service call, your dealer should call Dr. Wellness Spas for assistance. Upon satisfactory completion of warranty repairs, a Satisfaction of Service (SOS) form should be completely filled out by the service technician and signed by the customer.

NOTE: THE SPA SERIAL NUMBER SHOULD BE TAKEN DIRECTLY OFF THE SPA SO THE CORRECT WARRANTY IS APPLIED.

3. Upon request, the defective parts must be returned. Dr. Wellness Spas will process the warranty claim(s) within fifteen (15) working days (if claim is received in the proper time frame and all required information is submitted with the claim). Claims turned in late or without the proper documentation will be delayed. It is the responsibility of the spa owner to ensure that the spa is accessible for repairs. MANUFACTURER is not responsible for any cost associated with making spa accessible for repairs. If parts are required for repair, MANUFACTURER is not responsible for the cost of shipping of parts under the terms of this warranty agreement.



Manufacturer's Limited Warranty

Items Not Covered Under the Warranty

The following is a general overview of non-warranty items and work. This is NOT an all-inclusive list.

- | | | | |
|---------------------------|---|------------------------------|-------------------|
| * Shipping Charges | * Diagnostic Services | * Fuses | * Valve Handles |
| * Light bulbs of any kind | * Seals | * Filters | * Acts of Nature |
| * Wear and Tear | * Travel Charges | * Filling | * Chemical misuse |
| * Draining | * Damage caused by improper installation | * Removal and/or Replacement | |
| * Making Spa Accessible | * Any part not purchased from Dr. Wellness Spas | | |

The fuses, cabinet finish, and filters are warranted to be free of defects in workmanship and materials at the time of delivery. Any alterations that have not been PRE-APPROVED by the MANUFACTURER will void all warranties. If an alteration is approved by the MANUFACTURER, it is the consumer's responsibility to verify that the alteration is covered under warranty. Not all every service request is considered a warranty call. For example, moving the tub to access the problem is not considered a warranty call.

The MANUFACTURER understands that some problems take longer than the allowed time to correct. An authorization number will be required to extend warranty coverage for service calls requiring additional time. If you need re-authorization from the MANUFACTURER, a detailed description must be included with the warranty claim for approval.

Limitations

The Dr. Wellness Spas warranty is terminated if the spa has been subject to alteration, misuse, or abuse. Misuse or abuse is defined as but not limited to: use of spa in non-residential situations, water temperatures outside the ranges of 32 to 110 degrees, damage caused by clogged or dirty filters, damage caused by the absence of a hard cover, damage caused by failure to adequately maintain water chemistry, use of any type of acid, water left standing, or chemical imbalance. The spa owner is required to provide adequate access to the spa for any repairs or inspections. This warranty is terminated if any extra components area installed without the MANUFACTURER'S prior approval and consent or if any repairs have been attempted or made by anyone who has not received prior authorization from Dr. Wellness Spas.



Manufacturer's Limited Warranty

Disclaimer

Your sole and exclusive remedy and the Manufacturer's entire liability, if any, is limited to repair or replacement of the defective part, at the manufacturer's discretion, in accordance with the terms of this limited warranty. There are no additional warranties, express or implied, which extend beyond the terms of this written warranty. Dr. Wellness Spas makes no warranty of merchantability of the goods or the fitness of goods for a particular purpose. No agent, dealer, service company, technician or other parts representative is authorized to change, modify, or extend the terms, make any promise of performance or make any other representation including implied warranties for merchantability and fitness for a particular purpose as well as non-infringement in any manner whatsoever that are not included in the written warranties that accompany each Dr. Wellness Spa.

The MANUFACTURER'S liability, if any, shall not exceed the original amount paid for the original product. Under no circumstance shall the manufacturer or any of its representatives be liable for injury, loss, injury to person or damage to property, however arising, including indirect, punitive, special, incidental or consequential costs, expenses or damages, which may include, but are not limited to, loss of use, water damage, the removal of a permanent deck or other custom fixture whether the claim for such injury, loss, or damage is based on breach of contract, breach of warranty or tort, even if the MANUFACTURER has previously been advised of the possibility of damages.

This limited warranty gives you specific legal rights and you may have other rights which vary from state to state. Any disputes arising from the purchase of a Dr. Wellness Spa or this warranty are governed by the laws of the State of Tennessee.

